

STATE OF CALIFORNIA

EMERGENCY

FLOOD FIGHTING

Methods

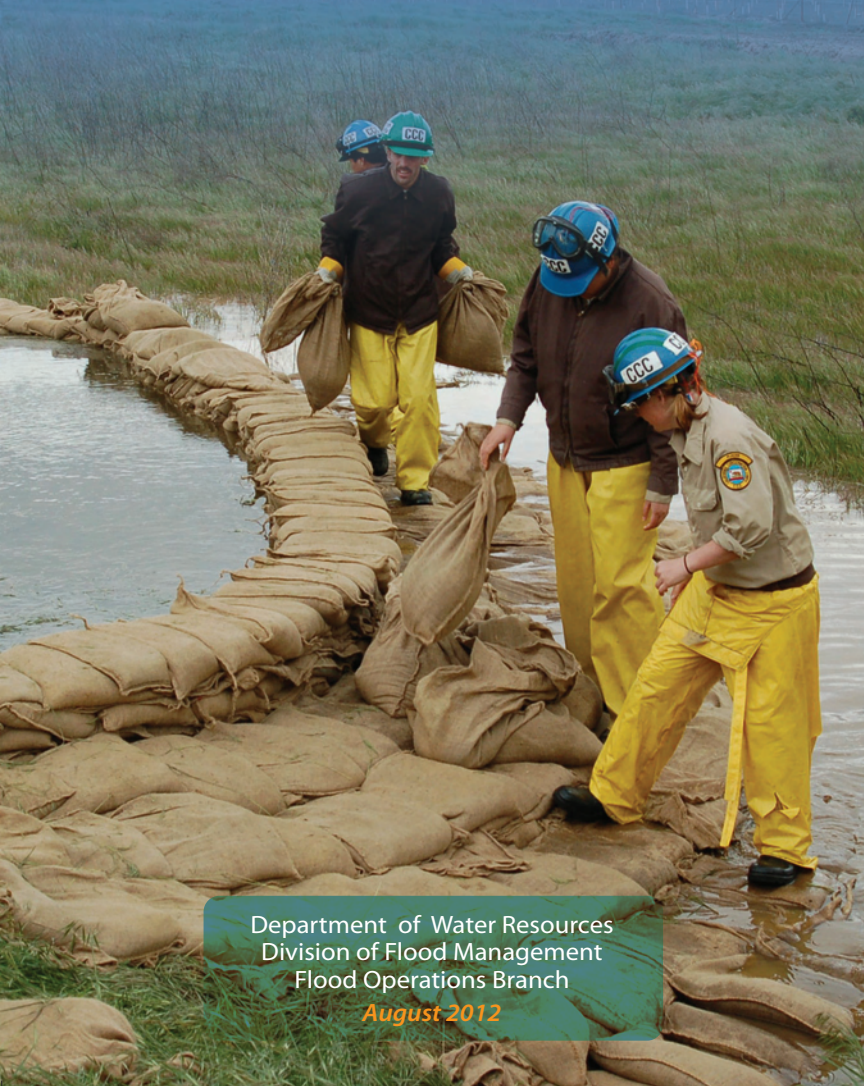

Department of Water Resources
Division of Flood Management
Flood Operations Branch

August 2012

STATE OF CALIFORNIA
CALIFORNIA NATURAL RESOURCES AGENCY
DEPARTMENT OF WATER RESOURCES

FLOOD FIGHTING

Methods



Division of Flood Management
Flood Operations Branch

August 2012

Prepared by

Rick Burnett

Water Resources Engineering Associate

with assistance from

Elizabeth Bryson

Water Resources Engineer

Xiao Li

Graphic Designer



Table of Contents

2	<i>Foreword</i>
3	<i>Levee and Embankment Threats</i>
3	<i>Patrolling</i>
5	<i>Filling Sandbags</i>
7	<i>Passing Sandbags</i>
8	<i>Sandbag Construction</i>
9	<i>Control of Overtopping (Sack Topping, Temporary Levee)</i>
12	<i>Control of Boils</i>
16	<i>Wavewash Protection</i>
22	<i>Raincoat Method</i>
23	<i>Emergency Spillway</i>
24	<i>Structure Protection / Diversions</i>
28	<i>Water / Storm Drain Protection</i>
29	<i>Flood Fight Safety</i>
33	<i>Flood Fighting Terminology</i>
36	<i>Reference Guide</i>
37	<i>Flood Fight Material/Equipment List</i>
38	<i>Levee Profile</i>

Foreword

The California Department of Water Resources (DWR), Division of Flood Management has been tasked to prevent, reduce, and mitigate the risk of damages associated with flooding. For over fifty years DWR has been the lead State agency responsible for responding to this costly natural disaster. Our mission is to prevent loss of life and damage to property and infrastructure.

Working together State, federal, and local agencies manage California's Flood Control System which consists of reservoirs, levees, weirs, bypasses, and retention basins.

This statewide system is managed with support from technologies such as weather and water forecasting, coordination of reservoir releases and a network of rain and stream gauges and snow pack monitoring. The information gathered is extremely important to emergency responders and the public.

The 'Flood Fighting Methods' outlined in this booklet have proven effective during many years of use by DWR, United States Army Corps of Engineers, and local agencies on flood-related emergencies. This handbook is published by the DWR Flood Operations Branch and is designed to be used with the Flood Fighting Methods class.

Levee and Embankment Threats

The main causes of levee failure or flood related problems due to high water are:

- Seepage through or under the levee heavy enough to cause a “boil”.
- Erosion of the levee or embankment due to swift moving water or wave action.
- Overtopping resulting from water-surface elevations higher than the levee or embankment.

Patrolling

The best defense against flood related issues and/or levee failure is to identify problems early and repair them immediately. Biannual levee inspections and effective high water patrolling make this possible. The following suggestions will help in organizing patrol teams for this work.

- Operate under the SEMS / ICS system and report to the appropriate section chief.
- Provide a sufficient number of workers for two 12 hour shifts.
- Provide each worker with a copy of this ‘Flood Fighting Methods’ handbook.
- Assign two people to each mobile patrol.
- Assign each mobile patrol vehicle an area no larger than can be inspected at least every 2 hours, with more frequent patrols as conditions warrant. Foot patrols may offer a more thorough inspection.

- Furnish each mobile patrol vehicle with radio/cell phone or other communication equipment, lights for night patrol, and the following materials: Laths, survey ribbon, permanent marker, pad and pencil, flashlight with extra batteries, 2 shovels, 1 sledge hammer, approximately 50 sandbags (empty), 1 roll of plastic sheeting (visquine), 1 box twine, 100 buttons, 25 wooden stakes, lifeline, personal floatation devices, blanket, First Aid kit, Directory of Flood Officials, and Flood Emergency Phone Card. (see Reference Guide on page 36)
- Identify potential problems: boils, seepage, erosion, cracks, sloughing etc.
- Instruct each patrol team on the correct filling and placement of sandbags. They should know what danger signs to watch for, and how to signal for help.
- Vehicles should remain on high ground in threatened areas. Always have escape routes and make them known.
- Instruct each leader to check with their team members frequently. Investigate all reported problems.
- Be aware of the locations of stockpiled sandbags and other tools and equipment at strategic locations.
- Be prepared to obtain more workers, tools, and equipment on short notice.
- Advise the officials of the district or agency responsible for emergency assistance in the area and if necessary, request their help, i.e. local emergency services office.
- Contact the nearest representative of the Department of Water Resources for technical advice and assistance.

Filling Sandbags

When filling sandbags you should work in pairs, with one person holding the bag while the other shovels in the fill material. The bag holder should find the most comfortable position while holding the bag open (see Figure 1 page 6). **The most common mistake made is overfilling bags.** The first shovel of fill should be placed on the lip of the bag to help hold the bag open. The shoveler should use rounded scoops of fill until the bag is approximately 1/3 full. While shoveling or holding, avoid extra movements (turning or twisting of the back) to prevent injury and reduce fatigue.



Filling Sandbags



Figure 1: Proper sandbag filling

Passing Sandbags



Passing Sandbags

To avoid injuries and maximize productivity emergency responders can be organized into a sandbag passing line or 'chain'.

The line is formed by standing facing the next person and slightly off set. The bags are passed down the center of the chain.



Passing Sandbags

Sandbag Construction

The use of sandbags is a simple but effective method of preventing or reducing damage from floodwater and debris. (see Figure 2) Suggestions for constructing sandbag structures are:

1. Close-weave burlap bags 18" x 30" are recommended for all sandbag construction when available.
2. Fold the empty top of the bag at a 45-degree angle to keep sand from leaching out.
3. Place each bag over the folded top of the preceding bag and stomp into place.
4. Stagger the second layer of bags over the seams of the preceding layer.
5. Stomp all bags to form a tight seal.
6. The last sandbag in a line is referred to as a Key Sack. The empty top of this bag is folded under and stomped into place.



Sandbag Wall Construction

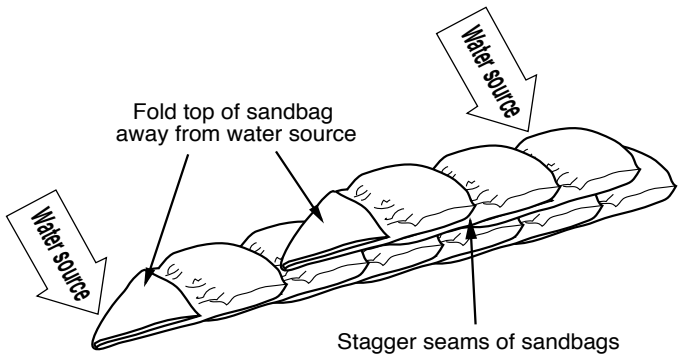

Figure 2: Fill sandbags 1/3 full, fold top of sandbag away from water source and stagger seams of sandbags.

Control of Overtopping

If any levee reach or stream bank is lower than the anticipated high water elevation, an emergency topping should be constructed to raise the grade above the forecast flood height. A sack topping may be required at road or stock crossings, low levee sections, or railroad crossings. The following sections discuss various methods for increasing levee and bank elevations.

Sack Topping

The most common form of flood control work is the use of sandbags for construction of temporary walls. The use of sandbag walls to increase the height of a levee section is called “sack topping” (see Figure 3). The sacks are laid “as stretcher rows,” or along the levee.

Alternate layers can be crossed if additional strength is needed. The sacks should overlap at least one-third and stomped firmly into place. When properly placed and compacted, one sack layer will provide about 3 to 4 inches of topping.

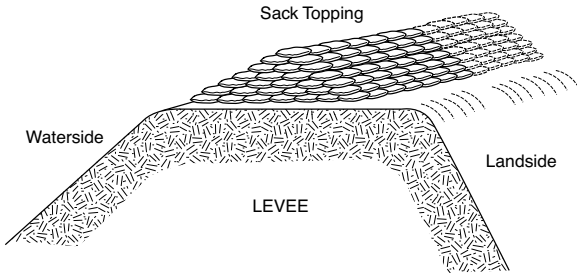

Figure 3: Sack topping on a levee



Sack Topping

Temporary Levee

This method is used to raise low areas during high water periods to prevent overtopping of levees, stream and riverbanks, small earthen dams, roadways, etc. To raise low areas, unfold a 20'x100'x10 mil roll of plastic sheeting and lay out flat on area to be raised (see Figure 4). Place fill material on plastic. Fold plastic over material, lay a single row of sandbags on the backside lip of plastic and on all seams. Fill material can be placed using bottom dump or dump bed trucks, front-end loader or manually.

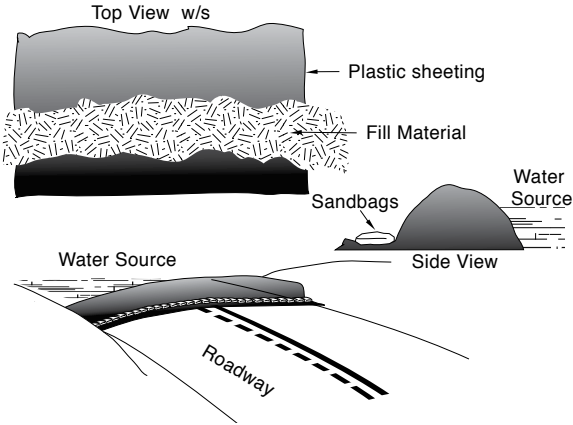

Figure 4: Temporary levee



Temporary Levee

Lumber and Sack Topping

Wooden panels are used on the waterside shoulder and reinforced on the opposite side with sandbags. The method is used to raise low reaches during high water and divert debris flows (see Figure 5). Stakes 2”x 4”x 6’ should be driven on the waterside shoulder 6 feet apart. A shallow trench is and lined with empty sandbags to provide a seal. Pre-constructed wooden panels are placed in the trench

and nailed to the landside of the stakes. This wall should then be backed with enough sandbags to support the panels against the expected high water. In some cases, it may be practical to back the panels with compacted earth in lieu of sandbags. Attach 2"x 4"x 10' lumber kickers to the stakes that support the panels, and drive 2' stakes into the levee crown. Use at least two nails at each joint to provide rigid construction.

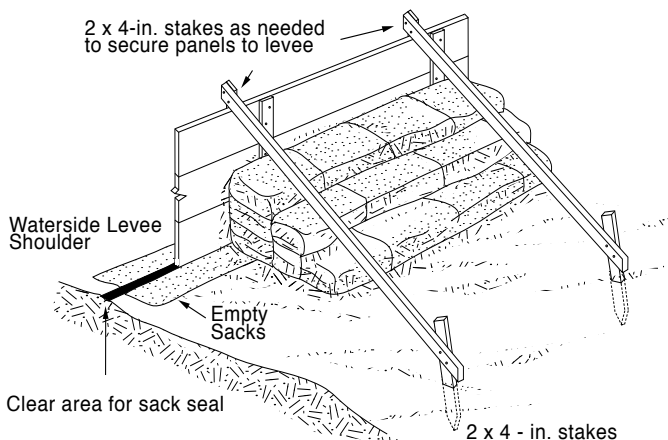

Figure 5: Lumber and sack topping

Control of Boils (*Away from Levee*)

A boil is a condition that occurs when water is “piped” through or under a levee and resurfaces on the landside. These weak points are generally caused by burrowing rodents or decomposed tree roots. High water pressure can begin to erode the interior of the levee and weaken the structure. Levee material will deposit around the exit point as the water discharges on the landside. If the boil is determined to be “**carrying material**” then corrective action is required to control the situation.

If left unattended the material that makes up the levee can be eroded at an accelerated pace, causing subsidence and overtopping of the levee. This could result in a levee break.

The common method for controlling a boil is to create a watertight sack ring around it. The sandbag structure should be high enough to slow the velocity of the water and prevent further discharge of material from the boil (see Figures 6 & 7). The flow of water should never be stopped completely, since this may cause the boil to “break out” in an area near the existing sack ring. A spillway must be constructed to direct water away from all boil sites.

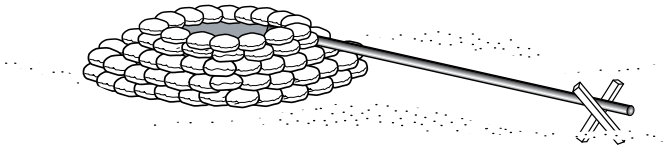

Figure 6: Boil sack ring

Bottom width should be at least $1\frac{1}{2}$ times the height. Do not sack boils that are not carrying material, but continue to monitor. Boils can begin to carry material after first located.



Boil Sack Ring

The sack ring should be large enough to encompass the area immediately surrounding the discharge point (3 to 4 feet diameter). If several boils carrying material are found, a single large sack ring may be constructed around the entire “nest” of boils.

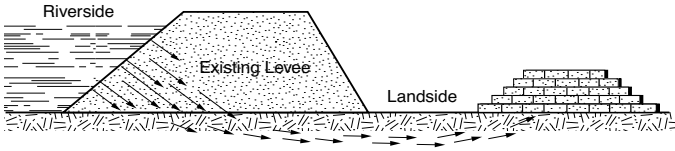

Figure 7: Flow of water through a levee

Control of Boils (On Levee Slope)

If the boil is close to or on the levee slope, a U-shaped sack ring may be built around the boil and keyed into the slope. Construction of this method can be difficult and requires substantial shoring up of the U-shaped sack ring structure. A spillway must be constructed to direct water away from all boil sites (see Figure 8).

NEVER completely stop the flow from a boil. This may cause the boil to “break out” in an adjacent area. ALWAYS control the boil to a point where it ceases to carry material and the water runs clear.



“U” shape Sack Ring

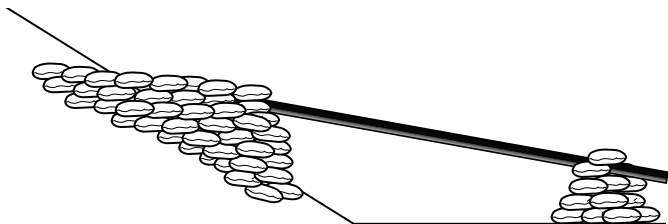

Figure 8: Spillways can be constructed by nailing two 2"x 6" boards together to form a V notch; PVC pipe; two parallel sandbag rows; visquine, etc.

Waterside Boil Inlet Detection

Water running through a levee and carrying material can sometimes be stopped on the waterside, thus eliminating the building of sack rings on the landside (see Figure 9). A six foot long section of 2" diameter metal pipe secured to a 5'x 6' foot piece of plastic or canvas can be rolled over the inlet hole on the waterside. Drive 1"x 3"x 2' stakes into the shoulder of the levee. Suspend half-filled sandbags on top of rolled-out material with twine and tie off to stakes. It can be difficult to locate the waterside inlet of boils. Sometimes a swirl is observed at the water's edge.

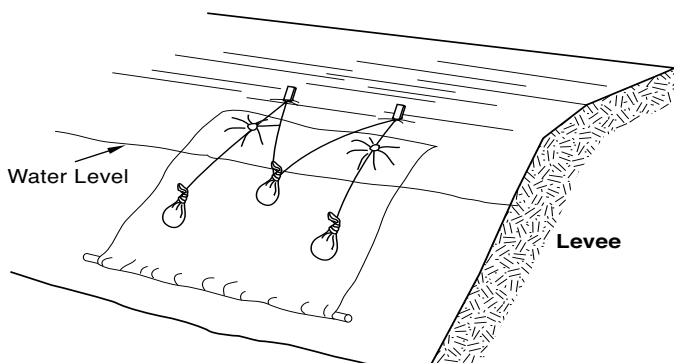

Figure 9: Waterside boil protection

Wavewash Protection

All levees adjacent to wide stretches of water should be watched during periods of strong wind to detect the early stages of wavewash erosion. If the slope is well sodded, short periods of high wind should cause little damage. However during sustained periods of strong wind and high water, experienced personnel should observe and monitor the effected areas.

Envelope Method

When used correctly, plastic sheeting is useful for wavewash protection. Visquine should be purchased in 10 mil rolls, 20 feet wide by 100 feet long. 1"x3"x2' wooden stakes are driven into the ground just above the levee shoulder on the side you wish to protect. Place the stakes 4 feet apart and stagger vertically by 1 foot as shown in Figure 10.

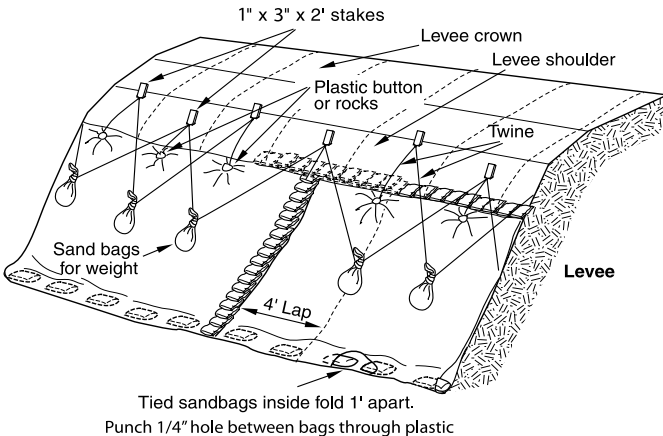

Figure 10: Wavewash Protection



Wavewash Protection

Avoid driving stakes in a straight line; this can cause cracking and sloughing of the slope. To provide added strength and leverage, drive stakes at a slight angle away from the water source with the wide (3") side facing the water. Be sure the stakes are well into the ground and are secure.

When rolling out the plastic sheeting it is helpful to use a shovel or similar long-handled tool. Eight to ten people should assist in shaking out the folds of the envelope. Be sure that both layers are held while the envelope is shaken out. Hold on tight! Use caution in strong winds. If the wind catches the plastic it could billow out and pull you along with it.

While flood workers hold the plastic securely, toss tied sandbags into the envelope. The tied sandbags (see Figure 12, page 20) are thrown into the bottom of the envelope with a one-foot gap between bags. The tied bags provide weight to hold the plastic against the levee slope.

A tie-down button or small stone (preferably round) is secured through both layers of visquine. If a stone is used, tie a slip knot and double half-hitch to secure it. Fasten buttons to the visquine and tie off to the stakes using a minimum 250 lb. tensile strength twine with these points in mind: (See Figure 11.)

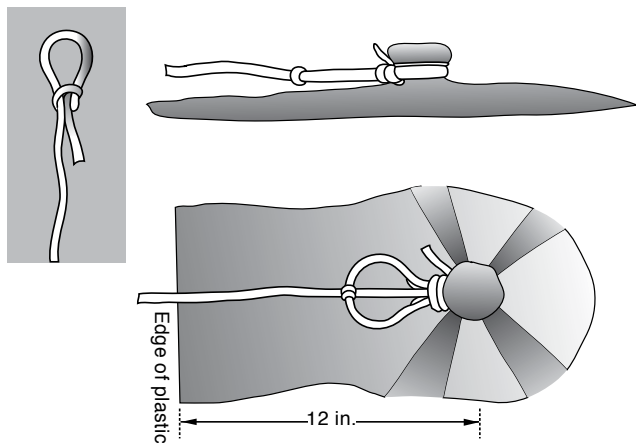

Figure 11: Plastic Tie-Down Buttons

1. Fasten button at least 1 foot from the edge of the plastic.
2. Fasten button to both layers of plastic.
3. Fasten button directly below stakes (one button per stake).
4. Tie twine low on stake for strength and to reduce tripping hazard.

Plastic sheeting is secured using tie down buttons. To attach plastic buttons to the plastic, tie a slipknot on the end of the twine; slip loop over button and plastic and draw tight. Tie two half-hitch knots around the throat of main body. Extend twine to large end of main body, tie a half-hitch knot around the end, and secure twine to stake (see Figure 11).

With the plastic secured to the stakes, punch a small hole between each tied bag in the envelope, (a pencil works well). These holes release water trapped in the envelope. **DO NOT** use a knife because a slice or slit will tear and



Button Tying

spread in the plastic. If further slope protection is necessary insert an additional envelope into the existing wavewash protection overlapping at least four feet. To secure the overlap to the stakes attach the two top layers with one button and the two bottom layers with another. The buttons line up with the stakes that are four feet apart. There should be four buttons securing the two envelopes.

Using a continuous piece of twine, hang tied bags from stakes in a zigzag fashion as shown in Figure 10. Tie a double half-hitch knot below the knot in each sandbag. ***Place each bag so that it hangs at the middle of the plastic directly below the stake between the two stakes from which it is suspended.*** Attach twine to every other stake with a double half-hitch. Add a second row of tied bags suspended from the stakes previously skipped. These bags will keep the plastic lying flat against the levee slope in windy conditions. If the upper portion of the slope needs protection, use an additional envelope. Be sure to place the upper layer over the lower layer by 2 to 3 feet. Finally place sandbags along all seams to prevent wind and water from entering the envelope. To prevent slippage, make sure the sandbags forming the top seam cap are half on the plastic and half on the

levee as shown in Figure 10. If the levee slope is too steep, some of the bags on the seam may be tied off with twine to the stake above the envelope for support.

Remember, wind is your worst enemy. When using plastic sheeting, be sure all seams are secured with sandbags, and make needed repairs to the envelope as soon as possible.

Tying Sandbags

Most sandbags are used with the open end folded. In some cases sandbags will have to be tied. Fill the bag 1/4 to 1/3 full of material. See Figures 12A–12D for instructions.

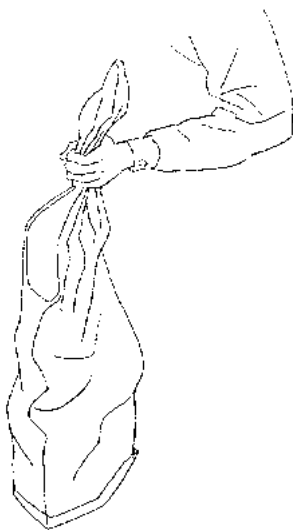

Figure 12A: Sandbag filled
1/4 to 1/3 full

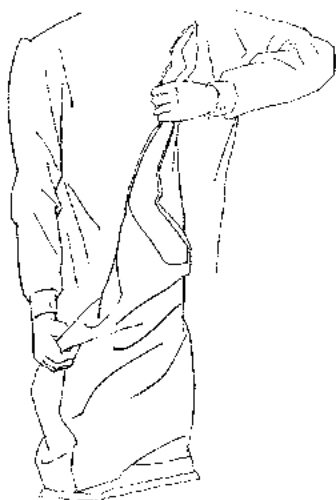

Figure 12B: Grasp bag at top
corner and spin

Figure 12C: The long tail should be twisted tightly and look like a piece of rope.

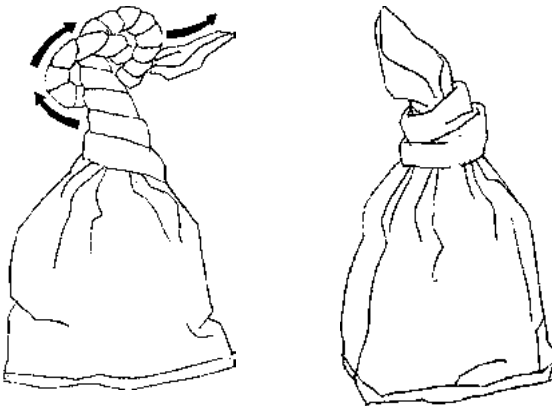
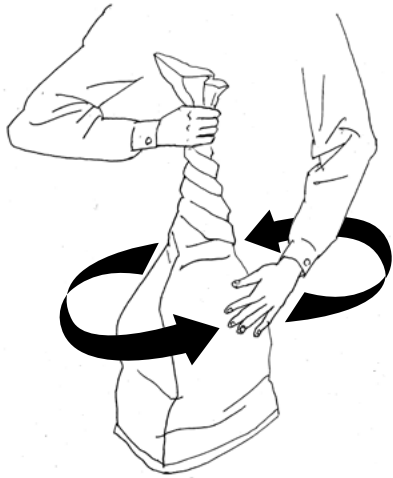

Figure 12D: Tie an overhand knot (pretzel knot) as low as possible on the bag.

Raincoat Method

The raincoat method is used to prevent further saturation of levee or hillside slopes. Plastic sheeting is laid out flat on the slope, sandbags are placed around the perimeter with additional bags placed randomly for weight.



Plastic sheeting is laid out flat on the slope, sandbags are placed around the perimeter with additional bags placed randomly for weight. If the slope is steep, wooden stakes can be driven into the ground just above the area to be protected. The stakes are 4 feet apart with a 1-foot stagger. The plastic is secured to the stakes with tie-down buttons or small round rocks (see Figure 13).

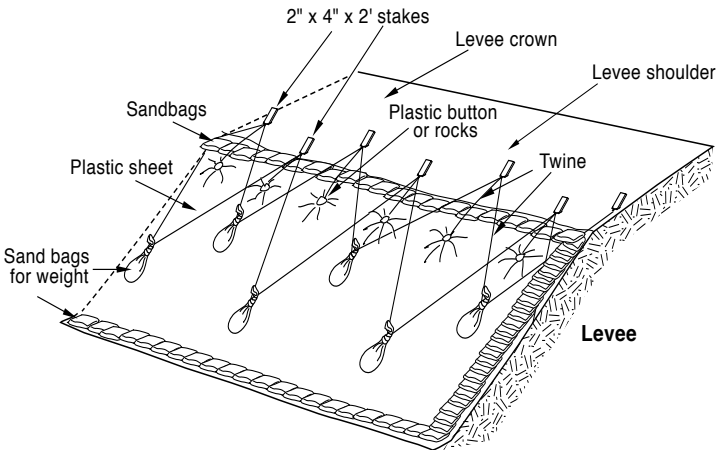

Figure 13: Raincoat method

Use a crisscross method of placing the sandbags (Figure 13) on the plastic. Place a solid row of sandbags on all edges of the plastic (half on the ground, half on the plastic).

Emergency Spillway

To prevent damage to the levee slope due to overtopping, an emergency spillway can be constructed.

Place plastic sheeting over area to be used for spillway. Line all sides with at least a single row of sandbags. Use additional tied sandbags on plastic for weight if needed.

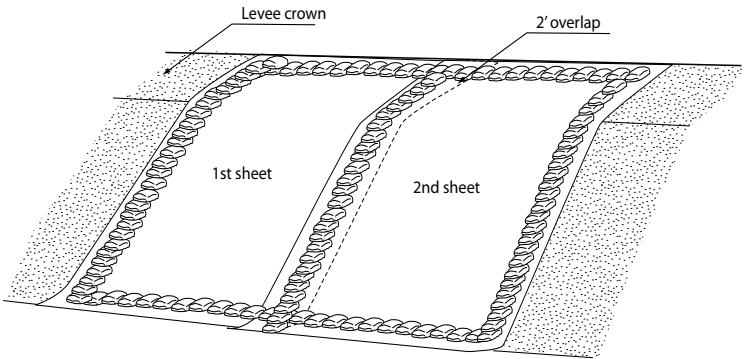

Figure 14: Emergency spillway using plastic sheeting and sandbags



Emergency Spillway

Structure Protection/Diversions

The main causes of damage to structures, homes, and property during heavy rains or flood flows are:

1. Flood water from overwhelmed storm drains and urban diversions, particularly on sloping streets.
2. Flood flows onto property through driveway openings and low spots in curbs.
3. Debris flow from hillsides that have been cleared of vegetation by fire or real estate development.

The flood fighting methods described in the following sections have proved effective in combating floodwaters and debris flows.

Diverting Water or Debris Flows Away from Structures

Homes and structures can be protected from floodwater or debris flows by redirecting the flow as shown in Figure 15. Sandbag barriers must be long enough to divert the flows away from all structures. Barriers constructed of sandbags or lumber can also be used to channel mud and debris away from property improvements.



Structure Protection



Structure Protection

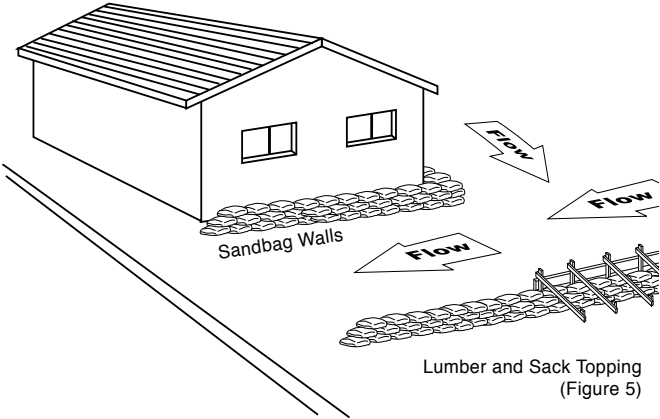

Figure 15: To divert mud, debris, and water, use sandbag walls or lumber and sack topping

Structure Protection

The following method is used for protection of buildings and other structures along lake shores and in similar situations where water is rising with little or no current.

Lay plastic sheeting on the ground and up the building walls to a point at least 1 foot above the predicted water elevation, and far enough out on the ground to form a half pyramid of sandbags (see Figure 16). Secure plywood over doors and vents. Overlap plastic sheeting and sandbags at corners of buildings.



Home Protection

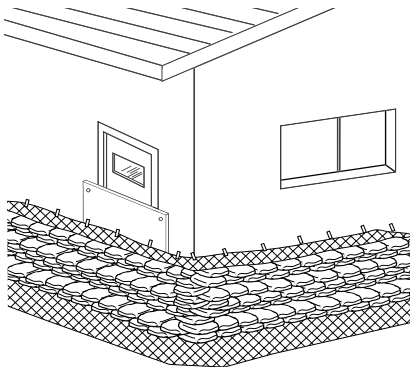
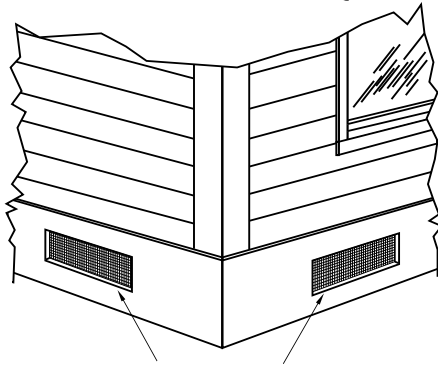

Figure 16: Structure protection

Wet Flood Proofing Requirements for Structures Located Within Special Flood Hazard Areas

National Flood Insurance Program regulations require that buildings on extended wall foundations or that have enclosures below the base flood elevation must have foundation or enclosure wall openings. These openings prevent the foundation or enclosure walls from weakening or collapsing under pressure from hydrostatic forces during a 100 year flood event. The openings allow flood waters to reach equal levels on both sides of the foundation or enclosure wall and minimize the potential for damage from hydrostatic pressure.

THESE OPENINGS MUST NOT BE BLOCKED IF THE BUILDING IS LOCATED WITHIN A SPECIAL FLOOD HAZARD AREA.



Foundation or wall openings must be kept open within special flood hazard areas

Figure 17: Foundation and wall openings in structures

For details refer to FEMA Technical Bulletins TB1-93 and TB-7.

These bulletins may be obtained from the FEMA web site at:

<http://www.fema.gov>

For additional information contact DWR Floodplain Management at

(916) 574-1475

Water / Storm Drain Protection

Water or sewer systems can be protected by placing corrugated metal pipe (CMP) over the utility hole (see Figure 18). Lay plastic sheeting up the walls of the CMP and place sandbags in the form of a half pyramid around the CMP to seal it to the pavement. This method will prevent mud and debris from entering the system and also act as a surge chamber.

CITY WATER PROTECTION

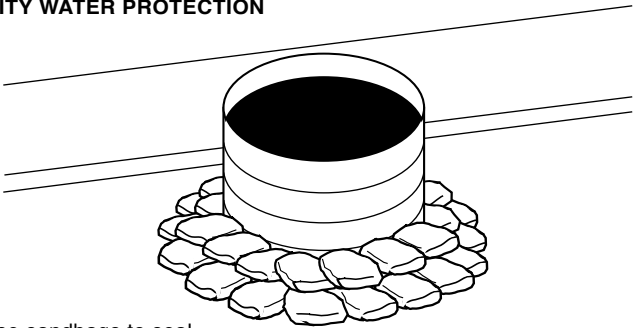

Use sandbags to seal pipe to pavement.

Using corrugated metal pipe (CMP) over utility hole to isolate sewer line or prevent contamination of water system.

Figure 18: Water / storm drain protection

Flood Fight Safety

Numerous potential hazards exist during flood events. These hazards are manageable if identification and communication occur on an ongoing basis. Personal safety requires a conscious effort that every flood fighter must consider in their various duties and activities.

- ***Changing Weather Patterns:*** This occurrence can affect existing conditions and create more serious situations. Always know the forecast and how it affects vulnerable areas, workers and the public.
- ***Changing Water Patterns:*** The rise and fall of water can occur gradually or very quickly. Knowledge of high water and how it relates to levees, communities, and workers is essential. Continuous monitoring and communication of water level influences (i.e. reservoir releases, tides, and drainage inflow) are very important. Always know your area and the flood history around you.
- ***Swift Water:*** High velocities of water are common during flooding events. Extreme caution should be used when anyone is exposed to high water. Workers should have flotation devices, throw ropes, and lifelines in the immediate area. Swift water rescue teams may be available. Use common sense and sound judgement around swift water. Know your resources and how to activate them prior to the event.
- ***Temperature Related Illness:*** During a flood fight, weather patterns can change constantly. Changes in temperature present the potential for hypothermia and heat exhaustion/stroke. Flood fighters should know the signs of distress for these types of illnesses and how to treat them. During cold, wet weather it is recommended that workers layer clothing to stay warm and dry. A dry

blanket and warm clear fluids should be on the work site for emergency use. In warm, hot weather lightweight clothing is recommended. If skin is exposed, a sun block agent may need to be applied. Plenty of drinking water should be on site and consumed regularly. Headgear is recommended in both hot and cold situations.

- ***Insect/Animal Exposure:*** Flooded areas force a variety of animals to evacuate to high ground. Workers in these areas should be aware of these animals and not handle them. If animal removal is needed, contact a local professional. Stinging and biting insects are prominent in certain flood-prone areas. Chemical repellents can be useful as a deterrent. A complete first aid kit should be on site.
- ***Vegetation:*** Noxious plants such as star thistle, stinging nettle, and poison oak are commonly found along rivers, streams, and levees. Avoid direct contact with this type of vegetation to prevent itching and rash. Consult medical personnel if symptoms persist.
- ***Sandpile Safety:*** When shovels are used for filling bags a safe distance for workers is essential. Sandbags and sand may contain contaminants. Have disinfectant available. Safety glasses or goggles are recommended for protection from blowing sand particles.
- ***Contamination:*** Flooded areas can potentially carry high levels of contaminants. Common contaminants include fuel, sewage, and pesticides. Local Haz-Mat teams should be contacted if needed. Always wear protective clothing to help limit contact with water. Carry antibiotic hand soap and wash thoroughly after working around floodwater.
- ***Exhaustion:*** Stress combined with long, physically demanding hours can have an adverse effect on the flood

worker. It is very important to recognize exhaustion or sleep deprivation and treat them immediately. Operation of vehicles, machinery, or equipment should be avoided. A shift rotation of personnel will help eliminate fatigue factors.

- **Body Mechanics:** Proper body mechanics while working on floods is very important. The body is expected to work long, physical hours during the event. Each individual must make a conscious effort to use safe lifting and weight distribution techniques. Watch your footing; surfaces can be slippery and cluttered with tripping hazards.
- **Construction Equipment:** There are times when equipment and people will occupy the same work area. Workers should wear safety vests and hard hats and be aware of their surroundings. Safety warning devices (i.e. backup alarms and lights) should be in-tact and working on all equipment. Communication and alertness are vital! All operators must be certified for their equipment.
- **Boat Travel:** Materials and/or personnel will sometimes need to be transported to work sites by boat. Operators of the watercraft must be certified. Flotation devices must be available for every passenger. Extreme care should be taken while loading and off loading.
- **Patrolling:** Patrolling is the key to effective flood fighting. Patrols will identify, initiate control, and monitor trouble spots in affected areas. Vehicle patrols should travel in two person teams with dependable communication devices. Lifelines, flotation devices, and a blanket should be in the vehicle for possible water-related accidents. Foot patrols should also have the same considerations. Extreme caution should be exercised when travelling saturated, cracking, or sloughing areas.

- **Vehicle Placement:** Vehicles in work areas along the levee should remain parked on high ground. This is usually the crown roadway. Vehicles should also be parked facing their access point. An escape plan should be communicated to all flood workers.
- **Structure Considerations:** When working around structures, be aware of downed power lines, natural gas or propane leaks, and unstable structure supports. Communicate with the structure owner if possible.
- **Safety Gear:** Rain gear, warm clothing, handheld lights, gloves, goggles, hardhat, boots, first aid kit, ropes, personal flotation devices (PFD), hip waders.



Flood Fighting Terminology

Boil	Also known as 'Sand Boil', is caused by water flowing through or under a levee, possibly carrying eroded levee material, and surfacing on the land side of the levee.
Button	A plastic tie down device used with plastic sheeting.
Emergency Spillway	Plastic sheeting and sandbags used to allow water to flow over a levee, protecting it from erosion. (Page 23)
Flood Fighting	An effort made to prevent or mitigate the effects of flood waters.
Home Protection	Plastic sheeting and sandbags placed around individual homes to protect from low current flood waters. (Page 26)
Lath	Long, narrow wooden stakes (4 feet long by 1 ½ inch wide) used to mark problem areas during high water patrolling. A brief description of the problem along with the date, time, and patroller's initials are written on the lath with a permanent ink marker. Brightly colored survey ribbon is attached to the lath for easy identification.
Levee	An earthen structure that parallels a river or stream designed to prevent high water flows from inundating urban and/or agricultural land.

Levee Break	A point in the levee system that has failed to perform its designed function, has eroded away and is allowing water to inundate land.
Levee Breach	The same as Levee Break but can sometimes describe a section of levee that has been intentionally broken. If intentional, also known as a relief cut.
Lumber and Sack Topping	Wooden panels and sandbags used to prevent overtopping and to divert water, mud, and debris flows. (Page 11)
Overtopping	When water has risen higher than the banks of a waterway or the top of a levee.
Plastic Sheeting	Made of polyethylene, these 100'x20'x10 mil rolls are sometimes referred to as visquine and are used for erosion control.
Rain Coat	A single layer of plastic sheeting and sandbags used to protect slopes from further rain saturation. (Page 22)
Relief Cut	Intentionally-removed section of levee to relieve hydrologic pressure upstream and downstream of the levee section.
Sack Ring	Multiple sandbag rings used to encircle a boil, slow the flow of water, and stop the erosion of levee material. (Page 13)
Sack Topping	A sandbag wall designed to prevent overtopping. (Page 9)

Sandbag	An 18"x30" bag (burlap or plastic) filled with sand or other appropriate material intended for use as a temporary flood fighting measure.
Sloughing	Soil movement or slides often caused by over-saturated levee or hillside slopes. Can also be referred to as 'mud slides'.
Structure Protection	Sandbags, wooden panels, or other materials used to divert water, mud, and debris flows away from buildings, homes, and other structures. (Page 24)
Temporary Levee	Use of plastic sheeting, fill material and sandbags to raise a low area on a levee or embankment. (Page 10)
Twine	250lb tensile strength polypropylene tying twine.
'U' Shaped Sack Ring	A sandbag structure used on levee slopes to control boils. (Page 14)
Wooden Panels	Wooden planks or plywood sheets used in conjunction with other flood fighting materials to prevent overtopping of levees or embankments and divert water.
Wavewash	Wind-generated waves breaking against a levee or embankment and possibly causing erosion.
Wavewash Protection	Plastic sheeting, sandbags, twine, stakes, and buttons used to prevent erosion of levee slopes and embankments. (Page 16)

Reference Guide:

DWR Division of Flood Management
www.water.ca.gov/floodmgmt

California Data Exchange Center
CDEC
www.cdec.water.ca.gov

California Emergency Management Agency
CalEMA
www.calema.ca.gov

National Weather Service
www.weather.gov

To request a copy of the Directory of Flood Officials or Flood Emergency Phone Card, contact the DWR Flood Operations Center at (916) 574-2619



Flood Fight Material/Equipment List

Fill/Repair material (Sand, Rock, Road Base)
 Sandbags (18" width x 30" length 10 oz.)
 Plastic Sheeting (100'x20'x10 millimeter rolls)
 Wooden Stakes (1"x3"x24")
 Bailing Twine (250lb tensile strength)
 Tie Down Buttons
 Geotextile Fabric (20'x100' rolls)

Patrolling

Patrol Vehicle (4Wheel Drive)
 Communication Devices (Radio, Cell Phone, Laptop Computer (e-mail)
 Global Positioning Satellite Handheld Device (GPS)
 Digital Camera
 Lighting (Flash Light, Flood Light)
 Batteries
 Lath (Bundle of 50)
 Survey Ribbon (Bright Colors)
 Permanent Ink Markers
 Patrol Log (Writing Pad and Pencil)
 Measuring Tape (100')

Tools

Shovels, Long Handle (#2 Mud Shovel)
 Sledge Hammer (10lb)
 Multi Purpose Lineman Pliers
 Pulaski
 McLeod
 Loppers

Safety

Rain Gear
 Rubber Boots
 Hard Hat
 Safety Glasses
 Gloves
 Boots
 Personal Flotation Device (PFD)
 Personal Safety Light
 Warm Clothing
 First Aid Kit

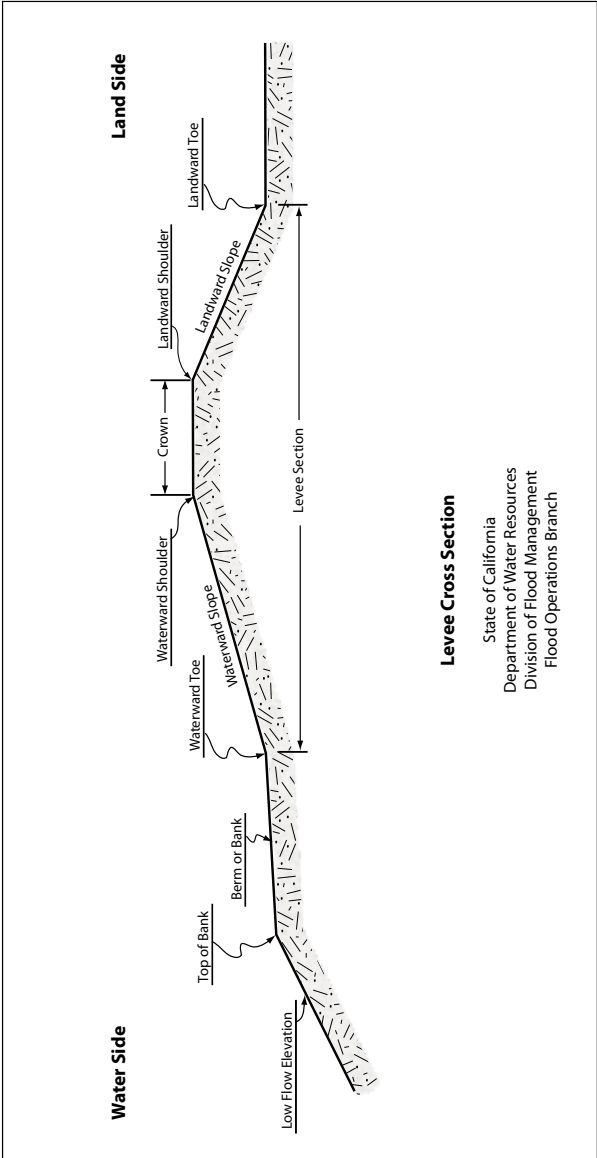

Levee Cross Section

State of California
Department of Water Resources
Division of Flood Management
Flood Operations Branch



For all flood training information, emergencies, questions, or for additional information, please contact :

State-Federal Flood Operations Center
(916) 574-2619
flood_center@water.ca.gov

For training information, contact:

Rick Burnett
Flood Fight Specialist
(916) 574-1203
rburnett@water.ca.gov
www.floodfightmethods.org

