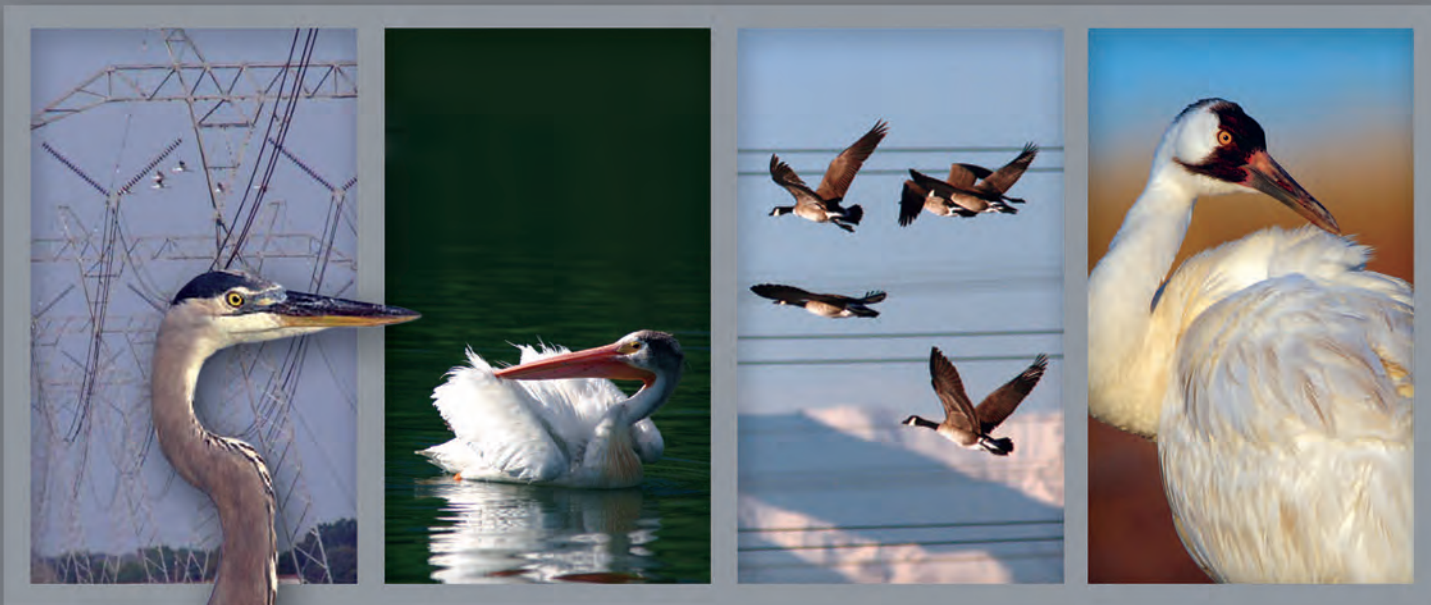


Reducing Avian Collisions with Power Lines



The State of the Art in 2012



Edison Electric
Institute

Power by Association[®]



SAMPLE

THIS PAGE INTENTIONALLY LEFT BLANK

Reducing Avian Collisions with Power Lines

The State of the Art in 2012

Prepared by:

Avian Power Line Interaction Committee

October 2012

SAMM



Additional copies of this book may be obtained through:

the Avian Power Line Interaction Committee (www.aplic.org) and the Edison Electric Institute (www.eei.org).

This book should be cited as follows:

Avian Power Line Interaction Committee (APLIC). 2012. *Reducing Avian Collisions with Power Lines: The State of the Art in 2012*. Edison Electric Institute and APLIC. Washington, D.C.

Cover photos copyright © (from left to right): Florida Fish and Wildlife Conservation Commission (transmission lines), Greg Forcey (great blue heron [*Ardea herodias*]), Jerry Liguori (American white pelican [*Pelecanus erythrorhynchos*]), Jerry Liguori (Canada geese [*Branta canadensis*] flying over power lines), and Laura C. Williams (whooping crane [*Grus americana*]).

Section header photos copyright © Jerry Liguori (Chapters 1 through 6), U.S. Fish and Wildlife Service (Chapter 7), Greg Forcey (Appendix A), Jerry Liguori (Appendices B, C, D, and E).

© 2012 by the Edison Electric Institute (EEI).
All rights reserved. Published 2012.
Printed in the United States of America.

No part of this publication may be reproduced or transmitted in any form or by any means, electronic or mechanical, including photocopying, recording, or any information storage or retrieval system or method, now known or hereinafter invented or adopted, without the express prior written permission of the Edison Electric Institute.

Published by:
Edison Electric Institute
701 Pennsylvania Avenue, N.W.
Washington, D.C. 20004-2696
Phone: 202-508-5000
Website: www.eei.org

Attribution Notice and Disclaimer

This work was prepared by the Avian Power Line Interaction Committee (APLIC) for the Edison Electric Institute (EEI). When used as a reference, attribution to APLIC is requested. APLIC, any member of APLIC, and any person acting on its behalf (a) does not make any warranty, express or implied, with respect to the accuracy, completeness, or usefulness of the information, advice, or recommendations contained in this work and (b) does not assume and expressly disclaims any liability with respect to the use of or for damages resulting from the use of any information, advice, or recommendations contained in this work.

The views and opinions expressed in this work do not necessarily reflect those of APLIC, EEI, or any member of APLIC or EEI. This material and its production, reproduction, and distribution by EEI does not imply endorsement of the material.

CONTENTS

Abstract		xi
Foreword		xv
Acknowledgements		xvii
Dedication: Richard “Dick” S. Thorsell (1927 – 2012)		xix
Chapter 1	Introduction	I
	Purpose and Scope of the Manual	I
	Reader Guide to the Manual	3
	Overview of Power Lines	4
	Perspectives for Dealing with Bird Collisions	10
Chapter 2	Progress in Dealing with Collision Issues	13
	North America	13
	International	17
	Future Research Priorities	19
Chapter 3	Avian Regulations and Compliance	21
	Overview of Existing Laws and Policies	21
	Permit Requirements	26
Chapter 4	Understanding Bird Collisions	29
	Susceptibility of Birds to Power Line Collisions	30
	Identifying Collision Mortality	30
	Variability in Reported Mortality Rates	31
	Biological Significance of Collision Mortality	32
	Biological Characteristics Influencing Avian Collision Risks	36
	Environmental Conditions Influencing Avian Collision Risks	46
	Engineering Aspects Influencing Avian Collision Risks	50
Chapter 5	Minimizing Collision Risks	53
	Opportunities for Minimizing Collision Risks	53
	Modifying Existing Power Lines	54
	Planning New Power Lines	64
	Public Participation to Address Social and Cultural Issues	72

CONTENTS

Chapter 6	Line Marking to Reduce Collisions	75
	Overview of Line Marking Devices	75
	Effectiveness of Designs	77
	Marking Constraints and Considerations	80
	Line Marking Devices	85
	Large Diameter Wire	100

Chapter 7	Avian Protection Plans	103
	Overview of Avian Protection Plans	103
	Components of an Avian Protection Plan	104
	Creating and Implementing an Avian Protection Plan	109

Appendix A:	Literature Cited and Bibliography	III
--------------------	--	-----

Appendix B:	Designing Site-Specific Studies for Collision Monitoring	I37
	Considerations for Site-Specific Collision Monitoring	I38
	Issues Related to Estimating Mortality Rates	I43

Appendix C:	Glossary	I47
--------------------	-----------------	-----

Appendix D:	Acronyms	I53
--------------------	-----------------	-----

Appendix E:	Resources	I55
--------------------	------------------	-----

ILLUSTRATIONS

FIGURE		PAGE
I.1	The highest wire on a transmission line is the shield wire, which can be difficult for birds, especially flocking birds such as waterfowl, to see.	2
I.2	Schematic of the electric power system from the generation facility to the customer (modified from Rural Utilities Service).	4
I.3	Transmission lines (left) and distribution lines (right).	4
I.4	Height comparison of transmission (typically 18.3 to 58 m [60 to 190 ft] tall) (A) and distribution structures (typically 6.4 to 14.6 m [21 to 48 ft] tall) (B).	5
I.5	Horizontal (A) and vertical (B) transmission line configurations.	5
I.6	Bundled phase conductors on a three-phase, single-circuit, 138-kV transmission line.	6
I.7	Distribution underbuild on a double-circuit transmission line.	6
I.8	Shield wires are the highest wires on a transmission line.	7
I.9	The neutral wire is usually positioned below the phase conductors on a distribution line.	7
I.10	Typical high voltage direct current transmission line structures.	8
I.11	Biologists gather data to assess the risk of bird collisions.	10
I.12	Engineers work with biologists to reduce risk through appropriate design and routing of power facilities.	11
I.13	Engaging the public may help a utility meet requirements for electrical reliability and reduce collision risk to birds.	12
2.1	APLIC has helped fund studies on the effectiveness of different types of line marking devices in reducing bird collisions with power lines.	14
2.2	In Canada, the first reported collision victims were snow geese.	16
2.3	Researchers have studied the effects of power line collisions on vulnerable species, such as the Ludwig's bustard of Europe, Asia, and Africa.	18
2.4	Because of the susceptibility of some endangered species, such as the whooping crane, power lines in these species' ranges require careful evaluation and routing.	19
2.5	APLIC, EPRI, and CEC are three organizations that provide some funding for research on avian/power line interactions.	20
3.1	The Migratory Bird Treaty Act of 1918 is the legal cornerstone of bird protection in the United States, protecting more than 1,000 North American bird species such as this cedar waxwing (<i>Bombycilla cedrorum</i>).	22

ILLUSTRATIONS

FIGURE		PAGE
3.2	Habitat Conservation Plans help landowners incorporate conservation measures for species, such as the wood stork (<i>Mycteria americana</i>), into their development plans.	23
3.3	Canada geese (<i>Branta canadensis</i>) are protected by both the Migratory Bird Treaty Act and Canada's equivalent, the Migratory Birds Convention Act.	24
3.4	Most songbirds, such as these horned larks (<i>Eremophila alpestris</i>), are protected by the Migratory Bird Treaty Act.	26
3.5	Bald eagles are protected under the Bald and Golden Eagle Protection Act and the Migratory Bird Treaty Act.	27
4.1	Collision risk is highly variable among species, with heavy-bodied birds, such as this common loon (<i>Gavia immer</i>), being more vulnerable because they cannot readily maneuver.	31
4.2	Because of their higher reproductive rates, common bird species are generally at less risk of population effects from power line collisions.	32
4.3	The United States' population of endangered whooping cranes has had such significant mortality from natural causes that additional power line collision mortality is now viewed as a threat to the species.	34
4.4	Whooping crane migration corridor in North America (2005 data from Stehn and Wassenich 2007).	35
4.5	Collision mortality has occurred with the expansion of the reintroduced population of the endangered California condor.	35
4.6	Wing loading and aspect ratio, among other factors, influence susceptibility to collisions (after Bevanger 1998).	36
4.7	Birds with high wing loading, such as swans, are more susceptible to collisions.	37
4.8	Flocking species, such as these snow geese, can be more vulnerable to collisions.	38
4.9	Aerial hunters that forage in flight within a couple hundred meters (several hundred feet) of the ground, such as swallows, can become collision victims.	39
4.10	Swans' poor frontal vision, along with their large size, increases their susceptibility to collisions.	40
4.11	Because they are nearsighted and fly at high speeds, mergansers may be unable to readily detect small diameter wires as they approach them.	41
4.12	Some juvenile birds, such as sandhill cranes, collide with power lines more frequently than their adult counterparts.	42
4.13	Endangered Newell's shearwater mortalities at a Kauai power line were mostly non-breeding adult and subadult birds.	42
4.14	Gulls (pictured) and waterfowl tend to make feeding flights at dusk and dawn, when reduced light increases collision risk.	43

ILLUSTRATIONS

FIGURE		PAGE
4.15	Power lines located between the foraging and roosting sites of wading birds, such as this white ibis (<i>Eudocimus albus</i>), may result in higher collision risk.	45
4.16	Research conflicts on whether or not overhead wires within a single habitat, such as this wetland, are more likely to cause collisions than those between two habitats.	45
4.17	Power lines crossing agricultural fields with seasonally attractive crops or residue can contribute to collision risk for some flocking species, such as cranes, waterfowl, songbirds, and these trumpeter swans (<i>Cygnus buccinator</i>).	47
4.18	Birds usually initiate migration in favorable weather conditions, but when they encounter inclement weather they may decrease their flight altitude, which increases collision risk when power lines are present.	49
4.19	Orientation of power lines parallel to ridges or narrow, low altitude flyways presents a lower risk of collision than perpendicular orientation.	51
5.1	Opportunities and strategies for minimizing collision risks.	54
5.2	The Bird Strike Indicator, a tool used to detect bird strikes with power lines, can be installed from a bucket truck or helicopter.	57
5.3	Reducing collisions in wooded areas. A tree line or other obvious obstacle at the appropriate height warns birds to gain altitude, which results in birds flying over the power line screened by the trees (after Thompson 1978).	59
5.4	Habitat modifications, such as cooperative programs to encourage earlier plowing of grain stubble, which is attractive to migrating sandhill cranes, may help to reduce collision risk.	60
5.5	Removing shield wires can reduce bird collisions but leaves the lines unprotected from lightning strikes and jeopardizes service reliability.	61
5.6	Buried power lines may be a solution to bird collisions in some instances, but can cost from 3 to 20 times more than overhead lines and have other environmental impacts.	63
5.7	Conceptual model of avian collision risk assessment.	65
5.8	Schematic of the terminology used when planning new transmission lines.	67
5.9	Potential collision risk (A) has been reduced (B) when bird-use areas are on the same side of the line (modified from Thompson 1978).	68
5.10	Routing with respect to local topographic features (after Thompson 1978).	69
5.11	Reducing collisions by clustering lines in one right-of-way (after Thompson 1978).	70

ILLUSTRATIONS

FIGURE		PAGE
5.12	Collision risks for separate (A) and clustered (B) lines (after Thompson 1978).	71
5.13	Public participation programs may provide information through a public relations campaign, but they also go further to engage the public in discussions and decision making (after EEI 2001).	72
6.1	Studies at the San Luis National Wildlife Refuge show that the line marking devices tested work well for most species, the exception being the American coot, which is more vulnerable to collisions because it primarily flies at night.	79
6.2	A helicopter crew installing line marking devices on a power line.	81
6.3	Positioning of line marking devices on the central portion of two shield wires on transmission lines (after Eskom Transmission [South Africa] 2009).	83
6.4	Positioning of line marking devices on one shield wire or staggered on two parallel shield wires.	83
6.5	Line marking devices staggered on a distribution line.	83
6.6	When a device is added to a power line, it may add to the loading of the line, which further increases under icy or windy conditions and may also cause problems for deicing operations.	84
6.7	Power structures and line markers can become targets for vandalism and a detriment to service reliability. Public participation and outreach programs, like this hotline, may reduce vandalism.	85
6.8	Aerial marker spheres, also known as aviation balls, were designed to make power lines more visible to aircraft operators.	86
6.9	Aerial marker spheres in use on a power line above a wetland habitat.	86
6.10	Spiral vibration dampers act to reduce line vibration, and they also make power lines more visible to birds.	88
6.11	The Bird-Flight™ Diverter is a spiral device made of PVC.	89
6.12	Bird-Flight™ Diverters installed on a distribution line.	89
6.13	The Swan-Flight™ Diverter is a double-ended spiral device.	91
6.14	Swan-Flight™ Diverters installed on the phase conductors of a distribution line.	92
6.15	Examples of suspended devices (swinging and fixed).	94
6.16	The FireFly™ FF (left) has a swinging tag for use in light winds and the FireFly™ HW (right) has a fixed tag to withstand higher, sustained winds.	95
6.17	BirdMark BM-AG (After Glow) in daylight (left) and darkness (right).	96
6.18	Hanging strips of neoprene, such as this Spanish-made Baliza Avifauna, are being used as line marking devices in Europe and South Africa.	97

ILLUSTRATIONS

FIGURE		PAGE
6.19	Baliza Avifauna installed on a power line in Europe.	97
6.20	The Avifaune Spiral is commonly used in France and other parts of Europe.	98
6.21	Avifaune Spirals installed.	98
6.22	The Mace Bird Lite is a spiral device with a central fluorescent tube that is illuminated by the ambient electrical field.	98
6.23	The RIBE line marking device is available as a swinging triangular tag or as a series of black-and-white, rigid plastic pieces that swing (pictured).	99
6.24	The Inotec BFD 88, a South African device, is a reflective stainless steel sphere reported to be visible from all angles and in low-light conditions.	99
6.25	Tree wire on all three phases of a distribution line marked with suspended devices.	100
6.26	Tree wire (right of pole) and standard wire (left of pole) on a distribution line.	101
6.27	Collision-electrocutions cause an electrical short, like this one caused by tree branches, and can kill two or three birds in a flock even if only one bird makes phase-to-phase contact.	101
6.28	Tree wire on the top phase conductor of a two-phase distribution line (vertical configuration) with line marking devices.	102
7.1	Utility employee training should include the reasons and methods for reporting bird mortalities, nest management protocols, proper disposal of carcasses, applicable regulations, and the consequences of non-compliance.	104
7.2	An Avian Protection Plan may include opportunities to enhance avian populations or habitat with nesting structures, habitat restoration, or other projects.	107
7.3	Raising public awareness about avian collisions and the utility's commitment to avian protection can increase support for an Avian Protection Plan.	108
7.4	Integrating an Avian Protection Plan into an electric utility's operations will help the utility meet demands for reliable, cost-efficient, and environmentally compatible power delivery while protecting and enhancing bird populations.	110
B.I	Classes used to describe birds' approach, crossing, and departure altitudes in collision studies on transmission lines (after James and Haak 1979).	139

TABLES

TABLE		PAGE
I.1	Quick guide to the Collision Manual.	3
I.2	Voltage classifications in North America.	4
4.1	Typical evidence of bird injuries or mortalities from power line collisions.	30
4.2	Average distance of collision mortalities from nearest water body.	46
6.1	Summary of data on line marking devices available in the United States.	76
6.2	Distance of collision mortalities from the nearest pole (parallel to distribution lines in the right-of-way).	82
6.3	Spacing and positioning for aerial marker spheres (aviation balls).	86
6.4	Representative studies for aerial marker spheres (aviation balls).	87
6.5	Spacing and positioning for spiral vibration dampers (SVDs).	88
6.6	Representative studies for spiral vibration dampers (SVDs).	88
6.7	Spacing and positioning for Bird-Flight Diverters (BFDs).	90
6.8	Representative studies for Bird-Flight Diverters (BFDs).	91
6.9	Spacing and positioning for Swan-Flight Diverters (SFDs).	92
6.10	Representative studies for Swan-Flight Diverters (SFDs).	93
6.11	Spacing and positioning for general designs of suspended devices.	94
6.12	Representative studies for general designs of suspended devices.	95
6.13	Spacing and positioning for FireFlies.	96
6.14	Representative studies for FireFlies.	96
6.15	Spacing and positioning for BirdMark BM-AG.	97
B.1	Summary of considerations and issues for designing site-specific collision monitoring.	137

ABSTRACT

PURPOSE AND SCOPE OF THIS MANUAL

Reducing Avian Collisions with Power Lines (Collision Manual) was first published by the Avian Power Line Interaction Committee (APLIC) and Edison Electric Institute (EEI) in 1994 under the title *Mitigating Bird Collisions with Power Lines*. The 2012 edition of this manual provides electric utilities, wildlife agencies, and other stakeholders with guidance for reducing bird collisions with power lines based on the most current information. This is especially important given the need to reduce bird injury and mortality from collisions, comply with bird protection laws, and enhance the reliability of electrical energy delivery.

PROGRESS IN DEALING WITH COLLISION ISSUES

In the United States, most studies of bird collisions have occurred since the late 1970s. These studies described the problem and led to a growing awareness among stakeholders. In 1989, APLIC was founded to address whooping crane (*Grus americana*) collisions with power lines. APLIC published its first *Collision Manual* in 1994 to summarize the knowledge of bird collisions with power lines at that time. National and international collaboration on bird/power line interactions has since grown. Research today includes studies on collision reduction, monitoring systems, and standardization of collision mortality data collection. Future priorities include improving the comparability of studies, testing and documenting line marker efficacy, and refining remote collision detection devices.

As power line infrastructure expands to meet the growing demand for electricity, the collision risk to avian species also seems likely to increase. Yet, this risk may be reduced by assessing potential avian impacts during line siting and routing, improving line marking devices, standardizing study methods, and increasing awareness.

AVIAN REGULATIONS AND COMPLIANCE

In the United States, three federal laws protect almost all native avian species and prohibit *taking* (killing or injuring) them even if the act was unintended and occurred as a result of otherwise legal activities. The Migratory Bird Treaty Act (16 U.S.C. 703-712) protects 1,007 (2012) North American migratory bird species (50 CFR 10.13). The Bald and Golden Eagle Protection Act (16 U.S.C. 668-668c) provides additional protection for these two species. The Endangered Species Act (16 U.S.C. 1531-1555) provides protection to federally listed species (designated as threatened or endangered) and to their critical habitat. Utilities in the United States should work with both the U.S. Fish and Wildlife Service (USFWS) and state wildlife agencies to identify permits and procedures that may be required.

In Canada, two laws protect avian species by prohibiting *take*. The Migratory Birds Convention Act protects most species of migratory birds in Canada. The Canadian Species at Risk Act provides for the protection and recovery of threatened and endangered species. Additional protection for species at risk has been developed by the provincial governments, such as the Alberta Wildlife Act. Utilities in Canada should work with the Canadian Wildlife Service and provincial wildlife agencies to identify permits and procedures that may be required.

UNDERSTANDING BIRD COLLISIONS

Understanding the nature of bird collisions is essential for minimizing them. Bird collisions with power lines result from a complex mixture of biological, environmental, and engineering factors. Biological characteristics include body size, weight, maneuverability, flight behavior, vision, age, sex, health, time of day, season, habitat, and habitat use. Environmental conditions include land uses, weather, visibility, lighting, and sudden disturbances.

ABSTRACT

Engineering aspects include size of lines, line placement, line orientation, line configuration, structure type, and sometimes obstruction lighting under Federal Aviation Administration rules.

It is difficult to extrapolate collision risk from one power line study and apply or compare it with other studies because of site-specific conditions and the lack of standard study methods, which result in variability of reported mortality rates. Species of birds reported to be susceptible to collisions generally have a large body size, long wing span, heavy body, and poor maneuverability. Examples include species of loons, storks, grebes, waterfowl, and some species of hawks and eagles. Flight behavior and other biological attributes contribute to species risk. Individual losses from collision mortality are unlikely to affect large and robust populations. However, for species that are rare or endangered, the loss of a few or even one individual may impact a local population or the overall population's viability.

MINIMIZING COLLISION RISKS

Engineers and biologists can work together to identify and address collision issues when modifying existing lines or planning new lines. Early consideration of risk factors may reduce the need for costly modifications later. In addition, while a utility is taking steps to minimize collision risk, a proactive public participation program can address social issues by building positive relationships, increasing public knowledge, identifying and responding to public concerns early, and promoting responsible behavior (e.g., discouraging vandalism of line marking devices).

When modifying existing lines, study options include collision monitoring, line modification studies, and avian risk assessment. Line modifications must be carefully evaluated to identify, quantify, and balance the existing risks with the potential effectiveness

and risks posed by the alternatives. Risk reduction options include line marking, managing surrounding lands, removing the shield wire, changing the size or configuration of wires, rerouting the line, and burying lines. Typically, the first options are line marking and managing surrounding lands because the remaining options are seldom feasible.

When planning new lines, three study options can be used to identify the optimal route: spatial analysis using GIS, field assessment, and avian risk assessment. Risk reduction options could include line placement, orientation, and configuration relative to biological and environmental factors.

LINE MARKING DEVICES

Studies suggest that most bird collisions occur with the shield wire, which is the smallest diameter and highest wire on a transmission line. Many studies of lines with high collision rates indicate that collision risk can be lowered by 50% to 80% when these lines are marked, though the most recent study published at this writing demonstrated only a 9.6% reduction (Barrientos 2012). However, recommendations for which device is the most effective and standard spacing are not possible due to differences in study designs and site-specific conditions. As a result of these differences, reduction rates may not be replicable from one line or study to another.

Since 1994, line marking devices have been further developed in North America, Europe, and South Africa. Advances in aerial marker spheres, spirals, and suspended devices include changes to design, colors, attachments, and materials in an effort to improve effectiveness and durability and to reduce possible damage to lines.

AVIAN PROTECTION PLANS

In 2005, APLIC and the USFWS announced their jointly developed *Avian Protection Plan Guidelines (Guidelines)*. An Avian Protection

A B S T R A C T

Plan (APP) is a voluntary, utility-specific plan for reducing the risks to birds and system reliability that result from avian interactions with electric utility facilities. An APP provides the framework necessary for implementing a program to reduce bird

mortalities, document utility actions, improve service reliability, and comply with bird protection laws. The *Guidelines* are intended to help utilities craft their own APPs for managing avian/power line issues that are particular to their location and operations.

SAMPLE

SAMPLE

THIS PAGE INTENTIONALLY LEFT BLANK

FOREWORD

Avian interactions with power lines, including collisions, electrocutions, and nesting have been documented since the early 1900s. Collisions with telegraph lines were first reported in 1876. However, it was not until the 1970s that biologists, engineers, resource agencies, and conservationists began to realize the extent of these interactions. It was then that they began investigating and addressing collision issues. We commend this early professional leadership in tackling a complex issue and building a foundation of credibility and cooperation that characterizes the relationship between the U.S. Fish and Wildlife Service (USFWS) and the Avian Power Line Interaction Committee (APLIC) today.

In December 1983, an ad hoc group began to address whooping crane (*Grus americana*) collisions with power lines in the San Luis Valley, Colorado. This work led to the 1989 founding of APLIC and the publication of *Mitigating Bird Collisions with Power Lines: State of the Art in 1994 (Collision Manual)*, which became the companion of *Suggested Practices for Raptor Protection on Power Lines: State of the Art in 1981 (Electrocution Manual)*. The 1994 *Collision Manual* brought together what was known about collision mitigation and presented research protocols for studying problem lines. It focused on standardizing these protocols so that data from various studies might be comparable and applicable to the issues experienced by electric utilities nationwide. This theme is carried forth and expanded upon in this 2012 revision.

Today electric utilities across North America recognize that bird/power line interactions may create operational risks, health and safety concerns, and avian injuries or mortalities, all of which reduce electrical reliability and increase a utility's liability. The USFWS is responsible for conserving and protecting United States trust resources covered by the Migratory Bird Treaty Act, Bald and Golden Eagle Protection Act, and Endangered Species Act. It is within this potentially adversarial framework that the longstanding collaborative partnership between industry and agency has emerged.

With this edition of the *Collision Manual* (now titled *Reducing Avian Collisions with Power Lines*) along with the 2006 *Electrocution Manual*, the 2005 *Avian Protection Plan Guidelines*, and Edison Electric Institute's 2001 *Introduction to Public Participation*, utilities have a toolbox of the latest technology, science, expertise, and field experience. APLIC and the USFWS hope you will use this edition of the *Collision Manual*, along with its companion documents, to help implement avian protection plans, conserve protected birds, and improve electrical system reliability.

Jerome Ford
USFWS, Assistant Director Migratory
Bird Program

Dave Bouchard
APLIC, Immediate Past Chair

Peggy Jelen
APLIC, Chair

ACKNOWLEDGEMENTS

APLIC wishes to express appreciation to the following individuals and organizations for contributing their time, resources, and expertise to making the 2012 edition of this manual possible.

PROJECT LEADERS

Dave Bouchard

Project Manager, Lead Editor
American Electric Power

Misti Schriener

Project Manager, Science Editor
Western Area Power Administration

Karen C. Hill

Project Manager, Technical Editor-Writer
Normandeau Associates, Inc.

James R. Newman

Lead Author, Technical Reviewer
Normandeau Associates, Inc.

CONTRIBUTORS AND REVIEWERS

Mike Best

Technical Reviewer
Pacific Gas and Electric

Jenny Carter

Editor
Normandeau Associates, Inc.

Peter Colverson

Contributing Author
Normandeau Associates, Inc.

Kara Donohue

Contributing Author, Technical Reviewer
Southern California Edison

Haley Edwards

Contributing Author, Technical Reviewer
Puget Sound Energy

Greg Forcey

Contributing Author
Normandeau Associates, Inc.

Caleb Gordon

Technical Contributor
Normandeau Associates, Inc.

Nikki Heck

Contributing Author, Technical Reviewer
AltaLink

Sherry Liguori

Technical Reviewer
PacifiCorp

Albert M. Manville, II

Contributing Author, Technical Reviewer
U.S. Fish and Wildlife Service

Susan Marynowski

Contributing Editor

Rocky Plettner

Technical Reviewer
Nebraska Public Power District

Von Pope

Technical Reviewer
Chelan County Public Utility

Dennis Rankin

Contributing Author
USDA Rural Utilities Service

Tom Stehn

Technical Reviewer
U.S. Fish and Wildlife Service (ret.)

Natalie Turley

Contributing Author, Technical Reviewer
Idaho Power Company

Mel Walters

Contributing Author, Technical Reviewer
Puget Sound Energy

Ondine Wells

Contributing Author
Normandeau Associates, Inc.

ACKNOWLEDGEMENTS

SPECIAL THANKS

APLIC recognizes those who pioneered research in avian collisions with power lines and those whose contributions made the 1994 edition of this manual possible: Carroll Belser, Bill Bolin, Wendy M. Brown, Jim Burruss, Edward Colson, Alan Ansel, Bob Turner, Jim Lewis, Rod Drewien, Sidney A. Gauthreaux, Jr., Franz Koops, John Ledger, A. Dean Miller, Judith H. Montgomery, Maurice Murphy, Dan Pearson, Leroy Sanchez, Frank Schlicht, Dick Thorsell, Pete Quincy, Phil Havens, Frank Moseley, Mark Czaplewski, Sheila Byrne, Jerry Roppe, Jerry Martinez, Joel Mazelis, and Echo Films' Morley Nelson, Norman Nelson, and Tyler Nelson. The vision, effort, and energy of each of these individuals continue to contribute to the growing understanding of this complicated issue.

APLIC also wishes to thank the following individuals for their service during the production of this edition of the manual: Brad

Loveless, Dave Bouchard, and Peggy Jelen for serving as Chair of APLIC and Rick Loughery for serving as the Edison Electric Institute Liaison to APLIC.

ADDITIONAL THANKS

Additional content was provided by Michelle Turner with the Canadian Electricity Association. Additional technical review was provided by the following engineers: Artis Karnei (American Electric Power), Chuck Wright (PacifiCorp), Bard Jackson (USDA Rural Utilities Service), and Wayne Galli (Clean Line Energy Partners).

CONTRIBUTING LITERATURE

A diverse collection of literature was used in the research to prepare this manual. APLIC acknowledges the great contribution that this body of literature made. This literature is included in Appendix A. Literature Cited and Bibliography.

This manual was funded by the Edison Electric Institute and the Avian Power Line Interaction Committee.

ACKNOWLEDGEMENTS

APLIC COLLISION SUBCOMMITTEE

The APLIC Collision Subcommittee deserves special recognition for their dedication to avian collision research and protection efforts and for their review and guidance in creating the 2012 edition of this manual.

Sarah Ball
Edison Electric Institute

Mike Best
Pacific Gas and Electric

Dave Bouchard
American Electric Power

Jim Candler
Georgia Power Company

Amy Dierolf
Progress Energy

Kara Donohue
Southern California Edison

Haley Edwards
Puget Sound Energy

Jodie Gless
Florida Power & Light

Donald Harron
AltaLink

Nikki Heck
AltaLink

Peggy Jelen
Arizona Public Service

Brendon Jones
AltaLink

Carl Keller
Bonneville Power
Administration

Sherry Liguori
PacifiCorp

Jim Lindsay
Florida Power & Light

Rick Loughery
Edison Electric Institute

Brad Loveless
Westar Energy

Al Manville
U.S. Fish and
Wildlife Service

Sam Milodragovich
Northwestern Energy

Chuck Partridge
Pacific Gas and Electric

Mike Pebosh
National Rural Electric
Cooperative Association

Rocky Plettner
Nebraska Public
Power District

Von Pope
Chelan County
Public Utility District

Dennis Rankin
USDA Rural
Utilities Service

John Rasmussen
AltaLink

Misti Schriener
Western Area
Power Administration

Tom Stebn
U.S. Fish and
Wildlife Service (ret.)

Natalie Turley
Idaho Power Company

Mel Walters
Puget Sound Energy

THIS PUBLICATION IS DEDICATED TO THE MEMORY OF

Richard “Dick” S. Thorsell

(April 11, 1927 – April 15, 2012)



Dick Thorsell had a lifetime devotion to birds and was one of the founders of APLIC. He brought electric utilities, government agencies, and environmental groups together to work in cooperation to study and mitigate bird deaths from power line collisions and electrocutions. Dick came to the Edison Electric Institute (EEI) in 1970 after serving as the Executive Director of the Stony Brook–Millstone Watershed Association in New Jersey. Dick was the producer of films on utility/natural resource issues, including *Silver Wires*, *Golden Wings*. The film featured Morley Nelson’s work on understanding and reducing raptor electrocutions. It brought awareness of electrocution issues to electric utilities and credibility to the industry for its efforts to address the problem.

Dick was a WWII Navy veteran, and in 1953 he graduated from Lehigh University with a B.A. in Conservation. During the summer of 1950, he took a job as a Ranger Naturalist for the U.S. National Park Service. In 1954, as a graduate student, he travelled to Bermuda to help determine what was destroying nests of the Bermuda petrel, or cahow (*Petrodroma cahow*), a bird that until

1951 was thought to have been extinct for more than 300 years. During 47 days of field observations he conceived a way to reduce nest predation of the cahow by the more aggressive white-tailed tropic bird (*Phaethon lepturus*), known in the islands as the longtail. His solution was credited as one of the most critical developments in the cahow’s recovery and conservation.

In 1988, Dick was honored by the Raptor Research Foundation for his pioneering efforts in raptor protection: “All who appreciate the flight, spirit, and symbolism of the golden eagle are in your debt; and those who know you well enough understand that having hundreds, if not thousands of living eagles to your credit, is sufficient personal award for your accomplishments.”

Dick received APLIC’s Morley Nelson Award in 2009 to acknowledge his efforts in pioneering avian/power line conservation and his dedication to developing and maintaining positive partnerships among the key interests in avian/power line issues.

Dick retired from EEI in 1991 and pursued his personal interests while remaining ever ready to advise the industry on developing issues and to keep us on track.



SAMPLE

THIS PAGE INTENTIONALLY LEFT BLANK



CHAPTER 1

Introduction

IN THIS CHAPTER

- Purpose and Scope of the Manual
- Overview of Power Lines
- Reader Guide to the Manual
- Perspectives for Dealing with Bird Collisions

Some birds flying in the vicinity of power lines may be susceptible to collision. While power lines are only one of numerous causes of bird injury and mortality, collisions with power lines can be reduced. This chapter introduces the problem of bird collisions, defines the categories and configurations of power lines, and presents the biological, engineering, economic, and social and cultural perspectives on bird/power line collisions.

PURPOSE AND SCOPE OF THE MANUAL

Reducing Avian Collisions with Power Lines (Collision Manual) was first published by the Avian Power Line Interaction Committee (APLIC) and the Edison Electric Institute (EEI) in 1994, under the title *Mitigating Bird Collisions with Power Lines*, as a comprehensive review of avian collisions with power lines (collisions) and recommendations for minimizing them. Since 1994, the understanding of bird collisions and the methods for reducing them has grown (e.g., Bevanger 1994, 1998; Janss 2000; Rubolini et al. 2005; and Jenkins et al. 2010). Collisions with power lines cannot be eliminated, but they can be reduced. This edition of the manual builds upon the foundation of the 1994 *Collision Manual* using the research and experience gained through the years since its original publication.

Power lines are an integral part of the modern landscape. Estimates of the number of miles of transmission lines in the United

States range from 862,000 kilometers (km) (535,622 miles [mi]) (J. Goodrich-Mahoney, EPRI, pers. comm.) to 1,024,534 km (636,616 mi) (EEI 2010) based on 2009 and 2010 data from the Federal Energy Regulatory Commission, North American Electric Reliability Corporation, and other sources. For distribution lines, the number of miles is less certain, but it is about five to six times that of transmission lines based on two large company systems (D. Bouchard, pers. comm.).

Some bird species that are active in the vicinity of power lines are more susceptible to collision and electrocution risk than others. The risks and reduction measures for bird electrocutions are addressed in the publication *Suggested Practices for Avian Protection on Power Lines: The State of the Art in 2006* (APLIC 2006).

Power lines are only one of numerous anthropogenic causes of bird collision mor-

tality. Others include tall buildings, windows, vehicles, communication towers, airplanes, and wind turbines (Avery et al. 1980; Erickson et al. 2005). Estimates of bird collision mortality vary widely because of differences in mortality monitoring and extrapolations of those data. Based on reviews, Erickson et al. (2005) estimated that buildings and windows account for most bird collision mortality in the United States, followed by power lines, automobiles, communication towers, and wind turbines. This manual only addresses bird collisions with power lines.

Interactions between birds and power lines are a complex mixture of biological, environmental, and engineering factors. Electric utility stakeholders need to understand the nature of bird interactions with power lines when siting, routing, and designing power lines and determining mortality reduction measures. This is especially true given the need to reduce bird collisions, comply with bird protection laws, and enhance reliable electrical energy delivery.

This manual was developed for electric utilities, wildlife agencies, and other stake-

holders and is based on what is known to date about collisions. It is intended to provide this audience with:

- An overview of power lines and perspectives on dealing with avian/power line collisions ([Chapter 1](#))
- A summary of current knowledge, literature, and field experience related to avian collisions with power lines and the factors that influence them ([Chapters 2 and 4](#))
- A discussion of the laws, regulations, and the operational implications of avian collisions ([Chapter 3](#))
- A review and discussion of current practices for planning, management options, study design, and devices used to minimize avian collisions with power lines ([Chapter 5](#), [Chapter 6](#) and [Appendix B](#))
- An overview for developing an Avian Protection Plan ([Chapter 7](#))
- A compilation of collision literature spanning several decades ([Appendix A](#))
- A glossary of collision terms and resources for further information ([Appendices C and E](#))

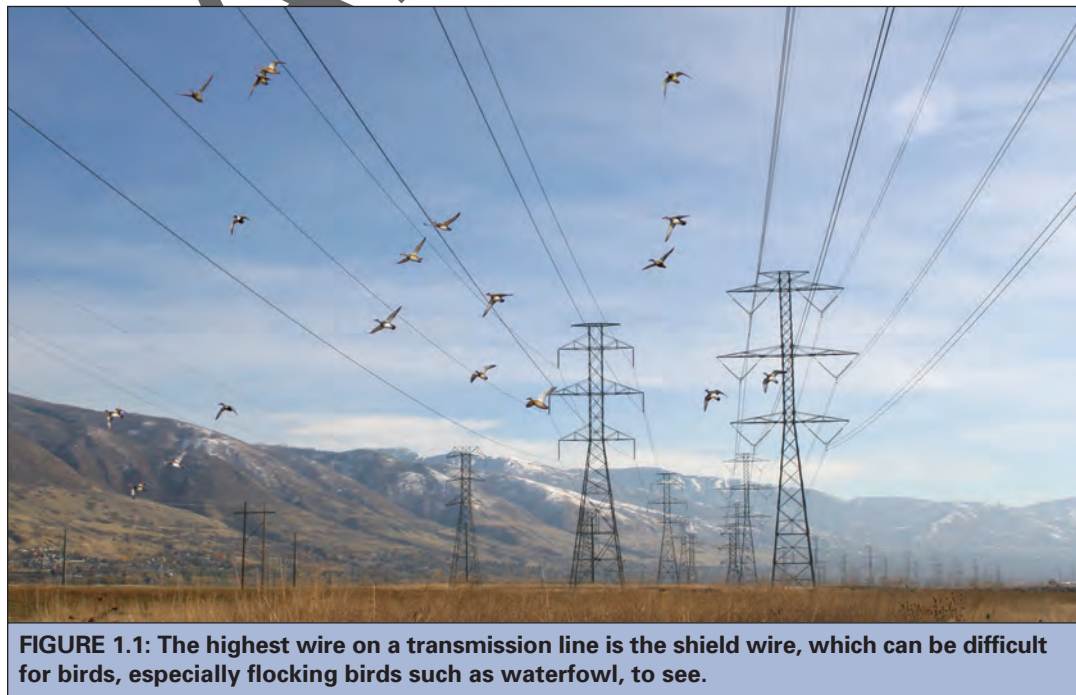


FIGURE 1.1: The highest wire on a transmission line is the shield wire, which can be difficult for birds, especially flocking birds such as waterfowl, to see.

**READER
GUIDE TO
THE MANUAL**

Table I.I provides a quick guide to common collision topics in this manual. Readers can also search the electronic version (a CD is included) for specific keywords. This manual consists of the following chapters and appendices.

Subject	Chapter(s)
Power lines, voltage, and the electric power system	1
Perspective of power line engineers	1, 4, 5, 6
Perspective of biologists	1, 4, 5, Appendix B
Perspective of the public and other stakeholders	1, 5, 6, 7
Advantages and disadvantages of underground power lines	1, 5
History of bird collisions and mitigation	2, 6, Appendix A
Current state of knowledge related to bird collisions	2, 4, 5, Appendix A
Funding organizations for collision research	2, Appendix E
Study methods and options	2, 4, 5, Appendix B
Strategies and approaches to address bird collisions	2, 4, 5, 6, 7
Laws and policies governing birds and bird mortality	3
Permits related to bird laws and policies	3
Factors that contribute to collisions	4
Variability in reported collision mortality rates	4
Significance of mortality for bird populations	4
Scientific methods to assess risk and impacts	4, 5, Appendix B
Methods for reducing bird collisions on an existing power line	5, 6
Methods for routing and designing a new power line while minimizing bird collisions	5, 6
Benefits of public participation	5, 7
Legal issues and other considerations for line marking	6
Effectiveness of line marking devices	6
How to develop a voluntary, utility-specific Avian Protection Plan	7

- Chapter 1. Introduction
- Chapter 2. Progress in Dealing with Collision Issues
- Chapter 3. Avian Regulations and Compliance
- Chapter 4. Understanding Bird Collisions
- Chapter 5. Minimizing Collision Risks
- Chapter 6. Line Marking to Reduce Collisions
- Chapter 7. Avian Protection Plans
- Appendix A. Literature Cited and Bibliography
- Appendix B. Designing Site-Specific Studies for Collision Monitoring
- Appendix C. Glossary
- Appendix D. Acronyms
- Appendix E. Resources

OVERVIEW OF POWER LINES

TRANSMISSION VERSUS DISTRIBUTION LINES

Power lines are rated and categorized, in part, by the level of electrical voltage they carry. Because the amount of electricity is large, voltage is usually specified as kilovolts (kV) where 1 kV is equal to 1,000 volts (V). In a power system, from the power generation facility to the customer (Figure I.2), four voltage classifications are used: power source, transmission, distribution, and utilization (Table I.2). Although there are exceptions to

these voltage classifications, they hold in general and will be used this way in this manual.

Voltage classification also depends on the purpose a power line serves. Transmission lines (≥ 60 to 765 kV) are used to transmit large blocks of electricity from the power generation facility to the load centers (communities). Within load centers, the high voltage of transmission lines is reduced at substations and then delivered via distribution lines (2.4 to 60 kV) for residential, commercial, and industrial uses. The distribution voltages are again stepped down to the lower voltages for the end user (120 to 600V) usually by pole- and pad-mounted transformers. Both transmission and distribution lines are power lines, a term used throughout this manual (Figure I.3).

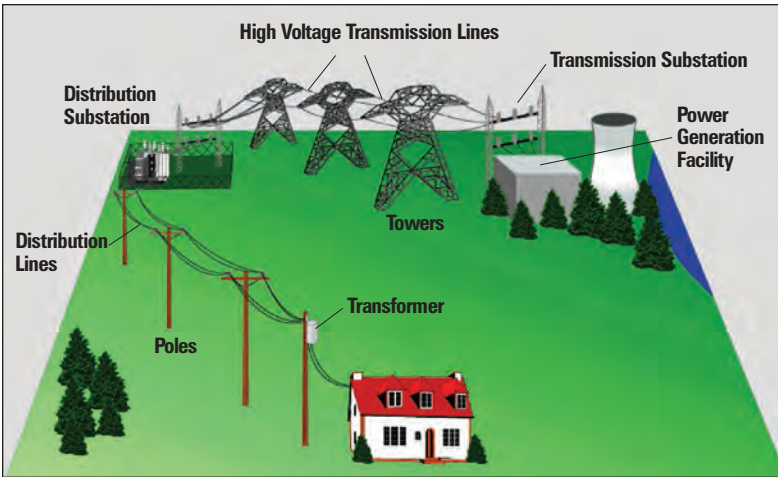


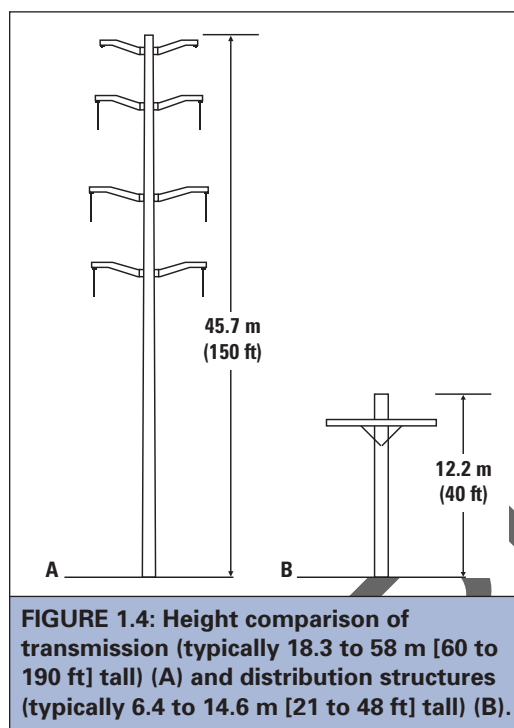
FIGURE 1.2: Schematic of the electric power system from the generation facility to the customer (modified from Rural Utilities Service).

TABLE 1.2: Voltage classifications in North America.	
Classification	Voltage
Power Generation Facility	12 V to 22 kV
Transmission	60 to 765 kV*
Distribution	2.4 to 60 kV
Utilization	120 to 600 V

* This is the typical range for transmission; however, there are exceptions.

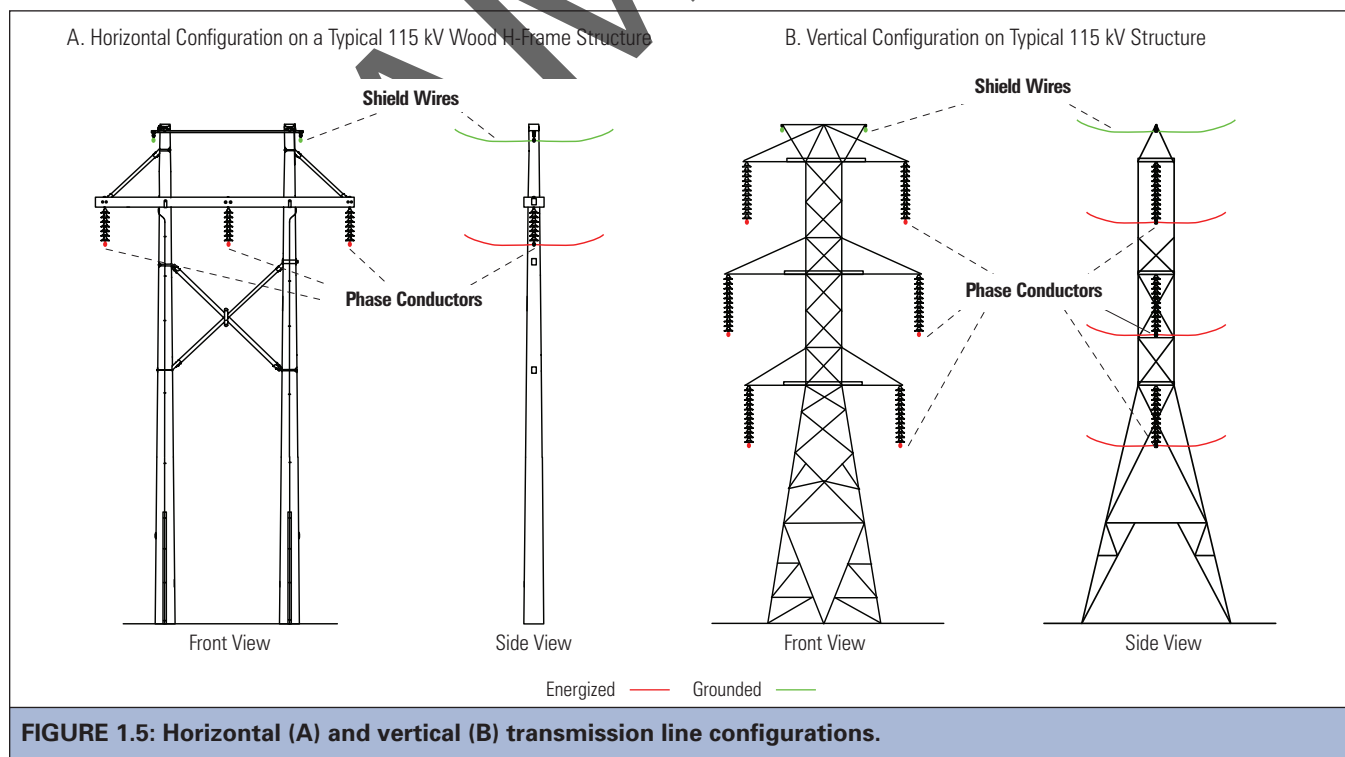


FIGURE 1.3: Transmission lines (left) and distribution lines (right).



POWER LINE CONFIGURATION

Power lines may be energized (carrying electricity) or non-energized (grounded). Energized lines are called phase conductors. Distribution lines may have one, two, or three phase conductors per circuit. Alternating current (AC) transmission lines always have three phases per circuit, and structures may carry multiple circuits. For example, a three-phase, double-circuit line would have six phase conductors. Phase conductors may be configured horizontally or vertically on the tower or pole (Figure 1.5). High voltage transmission lines may be bundled, which means two to six lines per phase are placed in close proximity to each other instead of using only one line per phase (Figure 1.6). Distribution lines may also be installed on transmission structures below the transmission lines; this is referred to as a distribution underbuild (Figure 1.7).



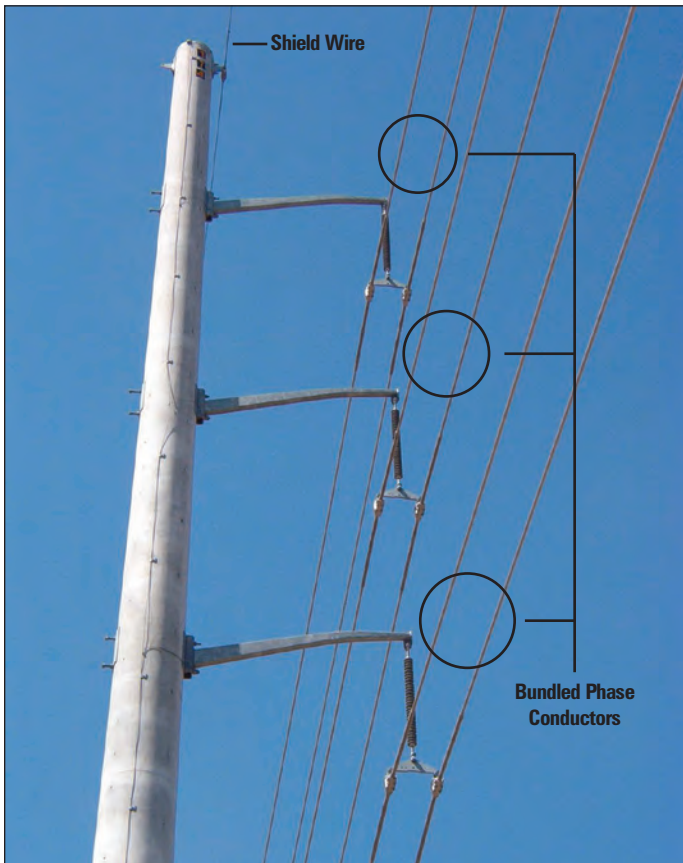


FIGURE 1.6: Bundled phase conductors on a three-phase, single-circuit, 138-kV transmission line.



FIGURE 1.7: Distribution underbuild on a double-circuit transmission line.

Non-energized conductors are at ground potential or zero voltage potential. There are two kinds of non-energized conductors: shield wire (also called static wire or overhead ground wire) and neutral wire.

Shield wires are installed above the phase conductors on transmission lines to protect them from lightning (Figure 1.8). Static electricity from the shield wire is taken to earth (ground) by grounding conductors. In a low lightning area, some transmission lines with lower voltages (e.g., 69 kV) may not have a shield wire. Shield wires are the lines most

associated with bird collisions on transmission lines because they are the highest wire and are smaller in diameter (1 to 1.3 centimeters [cm]; 0.4 to 0.5 inches [in])¹ than phase conductors (2.5 to 5 cm [1 to 2 in]; bundled lines are multiples of these), making them more difficult to see (e.g., Savereno et al. 1996). When birds are flying at the elevation of shield wires or gaining altitude to avoid the more visible phase conductors, the potential for collision with the shield wire increases. For more information on how power line configuration affects collision risk, see Chapters 4 and 5.

¹ Measurements are provided first in metric, then in English form.

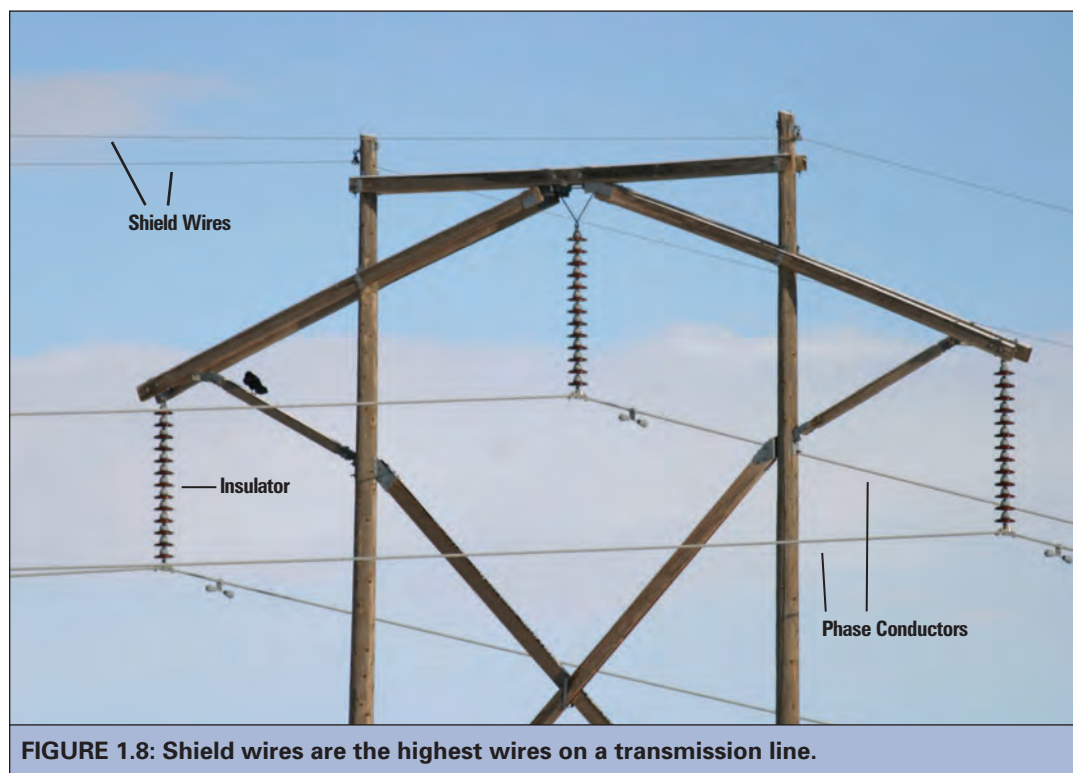


FIGURE 1.8: Shield wires are the highest wires on a transmission line.

The neutral wire, with regional exceptions, is installed below or parallel to the phase conductors on a distribution line (Figure I.9) and carries return current, which is taken safely to ground via grounding conductors. In high lightning areas there are exceptions where the neutral is also used as a shield wire on a distribution line.

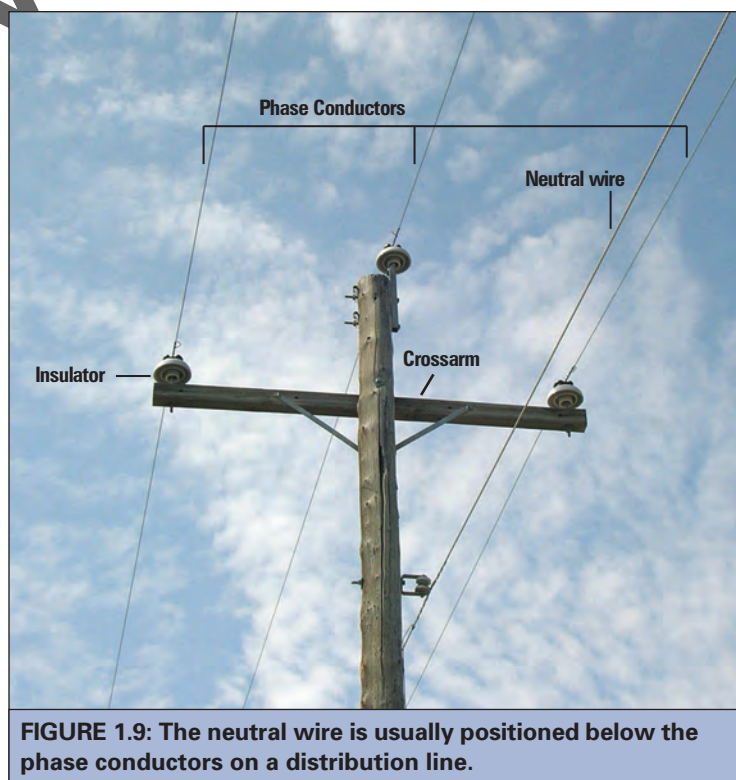


FIGURE 1.9: The neutral wire is usually positioned below the phase conductors on a distribution line.

High Voltage: Alternating Current versus Direct Current

Alternating current (AC) transmission and distribution systems are the world's most prevalent type of line. AC transmission systems consist of three phases, each phase consists of 1 to 6 wires (two or more is a bundle). Three phases make a circuit, and a line may have more than one circuit. AC phases may be arranged either horizontally or vertically. As voltage increases, loss over distance decreases, but at some distance high voltage direct current (HVDC) becomes more efficient than high voltage alternating current (HVAC). HVDC transmission systems have a growing presence in the United States and the world. They are most effective in transmitting electricity long distances at high voltages

(400 to 600 kV in North America and up to 800 kV in other countries). HVDC structure design is similar to HVAC designs, but with two poles instead of three phases (Figure 1.10). HVDC is transmitted on two bundled conductors known as positive and negative poles. The poles are spaced at least 9.1 meters (m) (30 feet [ft]) apart and are always arranged horizontally. Both systems require shield wires for lightning protection. Most importantly, both systems have the same cautions for attaching collision-preventive devices, i.e., these devices may be applied to shield wires, but are not always compatible with energized lines ≥ 150 kV or as manufacturers have otherwise demonstrated.

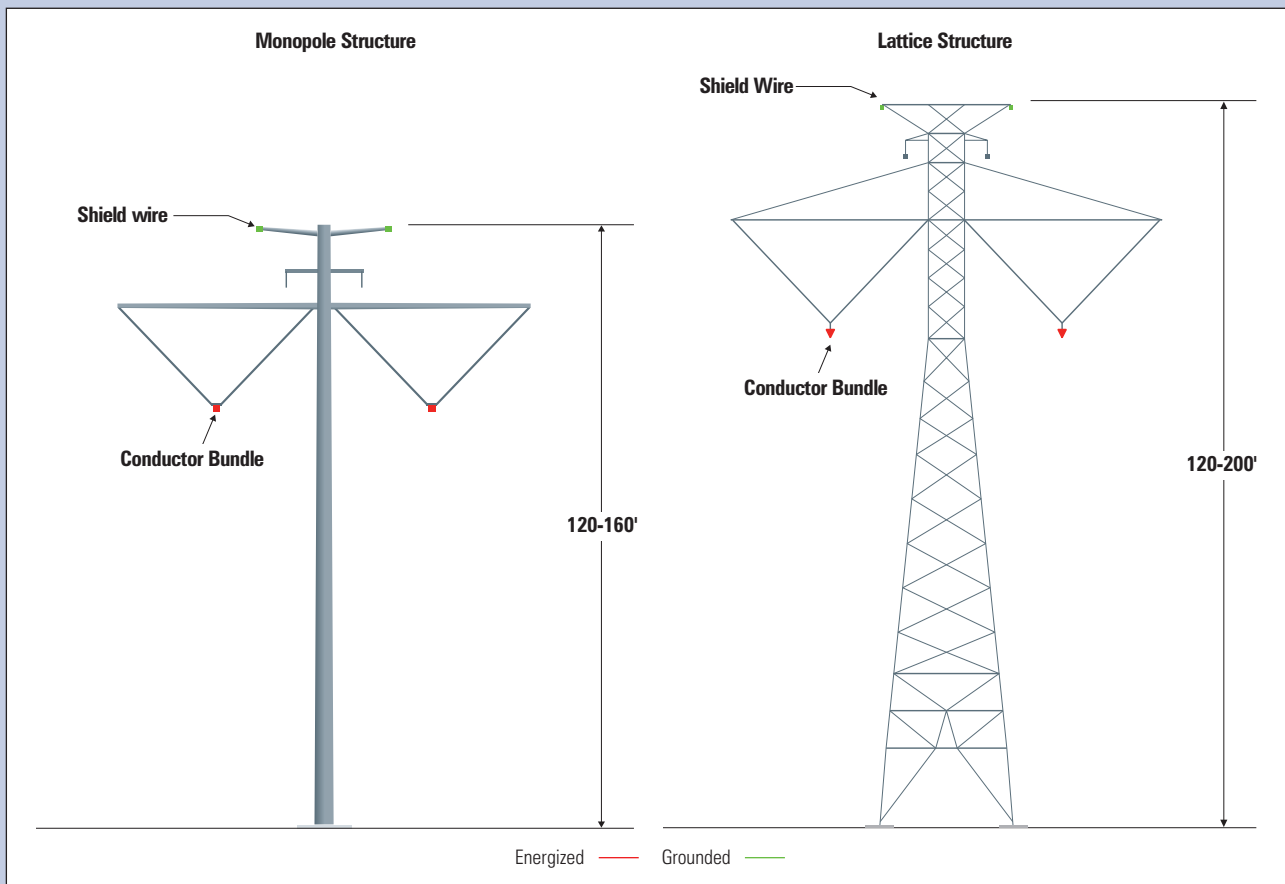


FIGURE 1.10: Typical high voltage direct current transmission line structures.

MEETING ELECTRICAL POWER DEMANDS (LOAD REQUIREMENTS)

A power line's voltage, configuration, conductor spacing, location, and structure type are determined by the present and anticipated power demands or load requirements the line will serve. Because electric utilities are required by law to provide reliable electrical service, they plan, fund, and build new power lines. If enough power is available in an area, then building new distribution lines can sometimes meet the increasing demand. Alternatively or additionally, transmission lines can be built to

bring power to the load center from distant power generation facilities.

Transmission line corridors are determined by the location of power generation facilities and substations in relation to load centers. Within the corridor, the preferred and alternative routes are determined, among other things, by rights-of-way (ROWs) availability, land use patterns, potential environmental impacts, terrain, archeological sites, proximity to habitable dwellings, and crossings over water, highways, and other power lines (see *Planning New Power Lines* in Chapter 5 for a discussion and illustration of the planning process).

Different ROW widths are required for different transmission line voltage ratings; these are generally determined by state statutes and the National Electrical Safety Code. ROW widths are also a function of structure height, span length, the conductor height above ground, and the low point of the conductor. ROW widths for transmission lines will vary from 15.2 m (50 ft) to more than 60.9 m (200 ft). Because ROWs are becoming increasingly difficult to obtain,

Transmission Lines and Renewable Energy

Current renewable energy mandates are leading to the development of wind, solar, and other renewable sources. Because these renewable energy sources are typically remote, new transmission lines are often needed to connect them to the grid and carry electricity to load centers.

Overhead versus Underground Power Lines

Electric utilities install power lines either overhead or underground depending upon numerous considerations. Some key factors include customer needs, costs, code requirements, terrain, voltage, and technological and environmental restrictions. Cost is a major concern as electric utilities have mandates to serve customers with high quality, reliable electric service at the lowest cost possible.

Power lines, particularly residential distribution lines, are installed underground in many areas throughout the country

where it has been found technically and financially feasible to do so. However, at transmission voltages, there are many more areas where installing lines underground is not feasible (see *Burying Power Lines* on page 62). It becomes more practical to build them overhead as the voltage of the line increases. Therefore, the focus of this manual is to provide guidance for addressing issues associated with reducing collision risks on overhead power lines.

it is a common practice to increase the voltage levels of lines in existing ROWs when statutes and safety allow. As voltages increase, the amount of power that can be transmitted

increases by a greater multiple.² Transmission voltages for carrying electricity long distances are generally in the range of 115 to 765 kV in the United States.

PERSPECTIVES FOR DEALING WITH BIRD COLLISIONS

A single approach is rarely successful in solving a complicated, multi-faceted issue such as bird collisions with power lines. An integrated approach that considers the biological, environmental, engineering, economic, and social and cultural perspectives of collisions is needed.

BIOLOGICAL AND ENVIRONMENTAL PERSPECTIVES

Biologists generally focus on gathering data to better understand the problem and creating solutions to minimize collision risk. Utility biologists and/or their consultants may be responsible for site evaluation studies and collision studies (see [Chapters 5 and 6](#) and [Appendix B](#)). Site evaluation studies determine baseline avian and habitat conditions and assess the possible collision risks to birds

following power line construction. Collision studies can help determine reliable mortality rates and quantify the effectiveness of measures taken to minimize collisions.

Collecting high quality data is critical for collision studies. Utilities should plan their studies carefully, using methods and metrics that can be replicated to gather and analyze data. The data should be sufficient for use in estimating the likelihood of collisions and for measuring the effectiveness of collision reduction efforts. In addition, methods must be sufficiently flexible to accommodate the species and site-specific conditions being studied and applied consistently throughout a study and between studies (Bevanger 1999; Barrientos et al. 2011).

In most cases, the approach to these studies is based on type of information needed to make management decisions, determine if line modifications are effective, and/or identify areas of bird activity and high collision risk. In some cases, wildlife agencies may recommend specific studies or protocols, and it is advisable to obtain their comments on a study design. Utilities and their consultants should also consider peer review by independent scientists for the study findings, since the results may undergo rigorous legal cross-examination if the issue is litigated. Publication in a refereed scientific journal is encouraged because it makes the data more widely available and contributes to a greater resource pool for the development of study design methods.



FIGURE 1.11: Biologists gather data to assess the risk of bird collisions.

© JERRY LIGUORI

² The carrying capacity of a line increases at a greater rate than the increase in voltage, i.e., one 765-kV circuit = three 500-kV circuits = six 345-kV circuits. Another advantage of higher voltage is that the voltage drop or loss over distance decreases as the voltage increases.



FIGURE 1.12: Engineers work with biologists to reduce risk through appropriate design and routing of power facilities.

© USDA/ARS

ENGINEERING PERSPECTIVE

Engineering research, development, and design are essential in the integrated approach to preventing or minimizing bird/power line collisions. Utility engineers should work with biologists early in the design and routing process to identify the key collision issues (see [Chapter 4](#)) and to develop feasible collision reduction strategies when modifying existing lines and planning new lines (see [Chapters 5](#) and [6](#)). Early science-based site evaluations and avian risk assessments can be part of improving route selection and line configurations to minimize collision problems. This can reduce or eliminate the need for costly modifications after construction. Design decisions also include other factors such as cost, routing through public or private land, crew availability, and material availability; as a result, a less favorable design for avian interactions may need to be used.

ECONOMIC PERSPECTIVE

No integrated approach would be complete without considering the economics of construction, operation, and maintenance of a power line. The cost for bird friendly power lines and configurations needs to be included during the design phase and route selection. A cost benefit analysis of appropriate collision minimization designs and mitigation can be performed. The later in the process that a biological or engineering solution is initiated, the more difficult, time-consuming, and costly it can become. Since electrical reliability is mandated by utility commissions, avoiding power outages, including those caused by birds, is a priority for electric utilities. Early planning can help meet requirements for reliability, regulatory compliance, efficiency, public acceptance, and cost-effectiveness.



© USFWS

FIGURE 1.13: Engaging the public may help a utility meet requirements for electrical reliability and reduce collision risk to birds.

SOCIAL AND CULTURAL PERSPECTIVES

In addition to cost and power reliability, the public may have concerns about power line design and placement, including esthetics, environmental effects, wildlife, and safety. Vandalism is also a persistent problem. Electrical components and line marking devices on power lines can become targets. Engaging the public may make it easier for a utility to meet the requirements of providing reliable electricity while reducing risks to birds. It

can also reduce delays and costs associated with controversy and litigation (EEI 2001).

Utilities and their consultants can use a variety of public participation tools to engage the public (see [Chapter 5](#) and [Appendix E](#)). Used effectively, these tools can build positive relationships, increase public knowledge, identify and respond to public concerns early, and promote responsible behavior (e.g., discouraging vandalism of line marking devices).



CHAPTER 2

Progress in Dealing with Collision Issues

IN THIS CHAPTER

 North America

 International

 Future Research Priorities

Much progress has been made since the 1970s in understanding and addressing bird collisions with power lines. This chapter recalls the conferences and studies that have occurred in North America and internationally. The major avian power line research organizations are introduced, along with future research priorities.

NORTH AMERICA

UNITED STATES

The first reported bird collision with overhead lines in the United States was documented in 1876 (Coues 1876); numerous bird carcasses, mostly horned larks (*Eremophila alpestris*), were reported during one week in a 5.8-kilometer (km) (3-mile [mi]) section of an overhead telegraph line between Cheyenne, Wyoming, and Denver, Colorado. Coues indicated that such collisions had already been reported in Europe, although no references were given. Another early report of collisions with electric wires in the United States was documented in 1904 (Emerson 1904). Emerson reported that shorebirds, as well as a black rail (*Lateralus jamaicensis*), collided with electrical wires over a salt marsh and evaporation ponds in the San Francisco Bay area. Avery et al. (1980) provides an annotated bibliography of other early power line collision literature.

Most collision studies have been published since the late 1970s and have led to a growing awareness among stakeholders. During the 1970s, Bonneville Power Administration conducted studies on reducing collisions with power lines (Lee and Meyer 1977; James and Haak 1980; and Beaulaurier 1981). Lee and Meyer (1977) proposed using devices such as image intensifiers for nocturnal observation and collision detectors that would measure the number of bird strikes on wires. They also suggested using thermal imaging, a relatively new technique at the time, to view birds and bats flying near power lines and wind turbines. Lee and his colleagues set a new scientific standard for studies of the interaction between birds in flight and power lines.

In 1978 bird/power line issues were addressed at a national conference sponsored by the U.S. Fish and Wildlife Service (USFWS),



FIGURE 2.1: APLIC has helped fund studies on the effectiveness of different types of line marking devices in reducing bird collisions with power lines.

© JERRY LIGUORI

the Environmental Protection Agency, and the Oak Ridge Associated Universities (Avery 1978).³ This conference was followed by a 1978 meeting at the Edison Electric Institute (EEI) in Washington, D.C. There, EEI and the Electric Power Research Institute (EPRI) discussed a research program on bird/power line interactions. EPRI funded an assessment of completed, ongoing, and planned research; an analysis of future research needs regarding the impact of power lines on birds in flight; and a series of studies aimed at developing different methods for measuring the impact of power lines on birds in flight.

In 1989, a group of biologists representing a wide range of utility interests, together with representatives from the USFWS and the National Audubon Society, formed the Avian Power Line Interaction Committee (APLIC).⁴ APLIC, in cooperation with the

USFWS, funded a study on the effectiveness of different types of line markers in the San Luis Valley of Colorado. Such a study was needed because aerial marker spheres were commonly recommended for power lines where bird collision potential existed, although there were no data that established their effectiveness. Further details can be found in Brown and Drewien (1995).

APLIC and EPRI were also instrumental in developing and providing funding for an international conference on bird interactions with utility structures (Miami, September 1992). The proceedings of that workshop included papers and case studies by researchers from various utilities and universities in the United States, Canada, South Africa, and India, and other organizations and agencies including the USFWS, Bureau of Land Management, and U.S. Navy.

³ Avery 1978 is the citation for the USFWS version of the proceedings; the original proceedings were documented by Oak Ridge Associated Universities. This reference will be noted as Avery 1978 in this document.

⁴ Founding APLIC utility members included Bonneville Power Administration, Edison Electric Institute, Central and South West Services (currently American Electric Power), Florida Power & Light Company, Houston Lighting and Power Company (currently CenterPoint), Nebraska Public Power District, Pacific Gas and Electric Company, Pacific Power & Light Company (currently Pacifi-Corp), Public Service Company of Colorado (currently Xcel Energy), San Luis Rural Electric Cooperatives, Southern California Edison Company, and Virginia Power (currently Dominion). A list of current APLIC members can be found at www.aplic.org.

In 1994, APLIC published *Mitigating Bird Collisions with Power Lines* (APLIC 1994) to compile the research on bird collision issues to date. Since then, research and reviews of this issue have continued. In 1999, EPRI held a workshop sponsored by APLIC and EEI entitled *Avian Interactions with Utility and Communication Structures*, which included papers and discussions on the bird collision issues these two industries face (see EPRI 2001). Every three to four years since 1976, electric utilities and utility organizations including EEI, EPRI, and APLIC help sponsor the International Symposium on Environmental Concerns in Rights-of-Way Management. This symposium often includes papers on bird collisions. APLIC also conducts avian protection workshops at its semi-annual business meetings and at other times through the year upon request (see www.aplic.org for information on upcoming workshops).

Since the early 2000s, the California Energy Commission (CEC) has sponsored a large number of research projects including identification of research needs on avian collisions with power lines in California: *A Roadmap for PIER Research on Avian Collisions with Power Lines in California* (Hunting 2002). CEC also has a searchable database on avian collision literature, *An Annotated Bibliography of Avian Interactions with Utility Structures* (CEC 2011).

Other CEC, APLIC, and EPRI sponsored studies include:

- *Human-related Causes of Raptor Mortality in Western Montana: Things are not Always as They Seem* (Olson 2001)
- *Bird Strike Indicator/Bird Activity Monitor and Field Assessment of Avian Fatalities* (EPRI 2003)
- *Raptor and Raven Electrocutions in Northwestern Mexico* (Cartron et al. 2004)
- *Corona Testing Devices Used to Mitigate Bird Collisions* (EDM 2004).
- *Assessment of Avian Mortality from Collisions and Electrocutions* (Dorin and Spiegel 2005)
- *Preventing Raptor Electrocutions in an Urban Environment* (Dwyer and Mannan 2007)
- *Evaluating and Reducing Avian Collisions with Distribution Power Lines at Cosumnes River Preserve* (Yee 2007)
- *Bird Strike Indicator Field Deployment at the Audubon National Wildlife Refuge in North Dakota* (Pandey et al. 2008)
- *Raptor and Corvid Response to Power Distribution Line Perch Deterrents in Utah* (Prather and Messmer 2010)
- *Evaluating Diverter Effectiveness in Reducing Avian Collisions with Distribution Lines at San Luis National Wildlife Refuge Complex, Merced County, California* (Ventana Wildlife Society 2009)
- *Contemporary Knowledge and Research Needs Regarding the Potential Effects of Tall Structures on Sage-grouse* (UWIN Cooperative 2010)
- *Protocol for Investigating the Effects of Tall Structures on Sage-grouse (Centrocercus spp.) Within Designated or Proposed Energy Corridors* (UWIN 2011)
- *Line Marking Study near Coleharbor, ND, 2006-2008* (WAPA 2011)

Bibliographies of Collision Literature

Appendix A of this manual includes the literature cited and a bibliography of collision literature. An annotated bibliography of early collision literature was provided by Avery et al. (1980). In addition, the California Energy Commission hosts a searchable database on collisions: *On-Line Annotated Bibliography of Avian Interactions with Utility Structures* (CEC 2011).



FIGURE 2.2: In Canada, the first reported collision victims were snow geese.

© DAVE MANKE, USFWS

CANADA

The first reported bird collision in Canada was published by Blokpoel and Hatch (1976) after several thousand snow geese (*Chen caerulescens*) were flushed by an aircraft into a transmission line. The geese had been feeding on a stubble field near Winnipeg, Manitoba. Between 25 and 75 geese were reportedly injured or killed after striking the wires.

Since then, there have been few published accounts of bird collisions in Canada. In 1997, the *Blue Jay* published a discussion on birds and power line risk (Curtis 1997). Other accounts can be found in proceedings from the Canadian hosted 5th and 7th International Symposium on Environmental Concerns in Rights-of-Way Management in Quebec (1993) and Alberta (2000). In 2007, a study on using a landscape-scale model to predict the risk of collisions in Alberta was completed (Heck 2007; Quinn et al. 2011). It examined the practicality of using GIS spatial modeling to predict areas with elevated collision frequency across large, existing electric service territories.

Bird/power line interaction knowledge is growing in Canada and more emphasis is being placed on identifying the root cause in relation to a utility's reliability issues. The cause of many outages has been identified as a direct result of wildlife interactions, including birds. Many utilities are also installing line marking devices in areas where collisions have been reported or suspected.

Depending on the species, collisions with power lines may be violations of federal and provincial wildlife laws (see [Chapter 3](#)) and can result in penalties. Most bird species present in Canada are migratory and are very often the same species present in the United States and subject to many of the same collision risks, which stem from the same biological, environmental, and engineering factors outlined in [Chapter 4](#).

Although Canada has wildlife laws in place, as of 2011 there is not a Canadian organization addressing the management of bird interactions with power lines; so Canadian companies have turned to American utilities for support by joining APLIC. In 2012, the first APLIC workshop in Canada was held in Banff. Electric utility representatives, consultants, contractors, and government regulators from across the country attended.

In addition to legal requirements and due diligence, Canadian companies have recognized that bird collisions need to be minimized for environmental, public relations, and public health reasons. Through increased management of avian collision issues, companies have been better able to demonstrate to utility staff, regulators, and the public, their commitment to reducing utility impacts on birds.

MEXICO

In Mexico, the USFWS has been working with officials of the Mexican government through the Trilateral Committee of the North American Free Trade Agreement, the

Migratory Bird Treaty with Mexico, Partners in Flight, and the National Wind Coordinating Collaborative to help Mexico better address avian collision and electrocution issues. These efforts are also tied to Mexico's

land-based wind energy development, which includes power line issues (R. Villegas-Patraca, pers. comm.; A. Manville, pers. comm.; Mexico Institute of Ecology and USFWS, unpubl. reports, respectively).

INTERNATIONAL

Important collision research has been conducted in Europe, Asia, and Africa. In 2003, BirdLife International prepared the guide *Protecting Birds from Power Lines: A practical guide on the risks to birds from electricity transmission facilities and how to minimize any such adverse effect* (BirdLife International 2003). It reviewed the risks from power lines, including collisions, and recommended standards to protect birds, siting considerations, use of underground power lines, hiding or obscuring power lines against more prominent landscape features, and the use of line marking devices. In 2007, BirdLife International developed a policy position statement on the risks to birds from transmission lines (BirdLife International 2007). In 2009, the Council of Europe issued *Follow-up Recommendation No 110, 2004* (Schuerenberg et al. 2009) on minimizing adverse effects of power lines on birds. It reviews standards and retrofitting methods and provides an exhaustive list of actions taken by 26 European countries.

In 2011, the United Nations Environment Programme (UNEP) for the African-Eurasian Waterbird Agreement (AEWA) and the Convention on Migratory Species (CMS) released a *Review of the Conflict between Migratory Birds and Electricity Power Grids in the African-Eurasian Region* (CMS 2011a) and the *Guidelines for Mitigating Conflict between Migratory Birds and Electricity Power Grids* (CMS 2011b). CMS (2011a) provides a summary of collision issues and hot spots in Europe, Asia, and Africa. Also in 2011, the *Budapest Declaration on Bird Protection and Power Lines* (MME 2011) was adopted by the participants of the

Budapest Conference, Power Lines and Bird Mortality in Europe. The declaration aims for all new construction of power poles to be bird-safe by 2016 and all dangerous poles to be retrofitted by 2020. The conference was attended by 123 participants from 29 European and Central Asian countries, the European Commission, UNEP AWEA, six energy and utility companies, experts, businesses, and non-government organizations.

In Asia, the risk of bird collisions with power lines is being recognized as more studies are conducted on bird electrocutions associated with new power line structures. For example, in Mongolia, while performing a review of raptor electrocutions on new concrete poles with metal crossarms, researchers found that Pallas' sandgrouse (*Syrrhaptes paradoxus*) were killed after colliding with power lines during an unusual seasonal relocation (Gombobaatar et al. 2010).

In Uzbekistan, systematic collision monitoring using standard protocols has not been conducted and therefore reported mortalities can only be considered anecdotal. However, these observations have shown that certain species are more susceptible to collisions and/or electrocutions. It is known that during spring and autumn migration, medium and large size birds collide with or are electrocuted on the power lines, which include rare and declining species like the steppe eagle (*Aquila nipalensis*), golden eagle (*Aquila chrysaetos*), imperial eagle (*Aquila heliaca*), osprey (*Pandion haliaetus*), short-toed eagle (*Circus gallicus*), and Saker falcon (*Falco cherrug*) (Abdunazarov 1987; Shernazarov and Lanovenko 1994).

In Kazakhstan, researchers found 409 bird carcasses of 34 different species during a 2006 survey of power line mortality. Many deaths were due to electrocutions and 44% were raptors. Deaths due to collisions were also noted (Lasch et al. 2010).

The great bustard (*Otis tarda*), which once ranged from Manchuria to Portugal, is now extirpated or endangered across much of the continent because of habitat loss, disease, and mortality from power line collisions (Janss and Ferrer 2000; Garcia-Montijano et al. 2002; Alonso and Martin 2005). It is one of the world's heaviest flying birds with a maximum weight of 21 kilograms (46 pounds). As a result, great bustards maneuver slowly in flight and are not able to avoid wires spotted at the last moment. Collisions have been observed by researchers in Mongolia (Kessler 2007). The research group notes that great bustard collisions with power lines are a common occurrence in developed Western Europe and are becoming more frequent in China.

In South Africa, The Endangered Wildlife Trust has a Wildlife & Energy Program that coordinates and sponsors research on bird/power line interactions (EWT 2011) (see [Appendix E](#)). This includes a study on



FIGURE 2.3: Researchers have studied the effects of power line collisions on vulnerable species, such as the Ludwig's bustard of Europe, Asia, and Africa.

© HANS HILLEWAERT/CC-BY-SA-3.0

the vision characteristics of the Ludwig's bustard (*Neotis ludwigii*) and blue crane (*Anthropoides paradiseus*) with respect to their ability to see power lines while in flight and how to reduce the collision risk for these species. It also includes a range-wide study of the collision rates of the Ludwig's bustard.⁵

In Kenya, a 2009 risk assessment of bird interactions with electrical infrastructure identified several sites of high collision risk to birds of conservation concern. These species included the grey-crowned crane (*Balearica regulorum*), lesser flamingo (*Phoeniconaias minor*), white stork (*Ciconia ciconia*), secretary-bird (*Sagittarius serpentarius*), and a number of vultures and raptors (Smallie and Virani 2010).

⁵ The range of the Ludwig's bustard includes Angola, Botswana, Lesotho, Namibia, and South Africa.

FUTURE RESEARCH PRIORITIES

As more power lines are built across the landscape, collision risk is anticipated to increase. Yet, this risk may be offset through assessment of potential avian impacts during siting and route selection, improved line marking devices and study methods, and increased awareness among stakeholders. With the continued growth in power line mileage, more collision research is needed. Because of the susceptibility of some endangered species, such as the whooping crane (*Grus americana*) and California condor (*Gymnogyps californianus*), power lines in these species' ranges will require careful evaluation and routing in addition to line marking devices and/or other collision reduction measures.

National and international collaboration on bird/utility interactions has increased markedly since the late 1990s. Guidelines for the development of Avian Protection Plans are a

product of this collaboration (see [Chapter 7](#)). Electric utilities are increasingly adopting avian protection policies, plans, and conservation measures, and APLIC will continue to provide guidance on bird collision issues. Cooperation in addressing collision issues will continue between electric utilities and wildlife agencies. This relationship will advance the collision risk reduction measures discussed in this manual (see [Chapters 5 and 6](#)).

Regional and species-specific studies of collision mortality and methods for minimizing collisions would be especially helpful. At this time there is no organized attempt to understand the extent and magnitude of collision mortality from power lines. Current knowledge of collisions is geographically, regionally, and site biased because most studies have been conducted on lines with known collision problems. In addition, avian/power line collision risk is not uniformly distributed because it is highly dependent on species and habitat variables. Bevanger (1999) recommended several areas of investigation that combine well-planned observational studies with experimental studies rather than non-standardized collision records that cannot be scientifically or statistically compared. Recent studies on the effectiveness of line markers (e.g., Yee 2008 and Murphy et al. 2009) follow these recommendations. Standardized protocols for monitoring mortality at communication towers (e.g., Manville 2002, 2009b; Gehring et al. 2009) and wind turbines (e.g., CalWEA 2011) could also provide models that could be adapted for power line mortality assessments.

The effectiveness of line marking devices needs further study. In particular, more research is required to determine the device and spacing best suited to different environmental conditions and species. Except for studies sponsored by the CEC and APLIC (e.g., Ventana Wildlife Society 2009; Yee 2008; WAPA 2011) relatively few systematic studies have looked at the comparative effectiveness



FIGURE 2.4: Because of the susceptibility of some endangered species, such as the whooping crane, power lines in these species' ranges require careful evaluation and routing.

of different line marking devices. Barrientos et al. (2011) conducted a meta-analysis of line marking studies, discussed the limitations, and provided recommendations for more scientifically rigorous evaluations. In addition, no systematic comparison of the

effectiveness of these devices with different species, in different habitats, or in different weather conditions has been conducted. As new styles of line markers continue to be developed and existing markers are modified, associated effectiveness testing will be needed.

Funding Organizations for Collision Research

APLIC, EPRI, and CEC are three organizations that provide some funding for research on avian/power line interactions (see [Appendix E](#)). The USFWS conducts limited primary research and funds state research through Section 6 Endangered Species Act grants.

APLIC funds research projects that further the knowledge of avian/power line interactions including:

- Assessments of collision and/or electrocution rates associated with power lines
- Risk assessments to identify factors contributing to collisions and electrocution mortality risks for different species
- Evaluations of impacts of power line construction on bird species

EPRI's research priorities emphasize information and monitoring systems that will improve understanding of and mitigating for avian interactions with utility facilities. These include the Bird Activity Monitoring System and avian vision studies that may help develop more effective collision prevention devices.

The CEC (Hunting 2002) identified a number of research priorities that still apply today and need to be considered to better understand avian collisions with power lines. These include:

- Standardizing mortality estimation
- Testing and documenting the efficacy of line marking devices
- Testing and documenting the efficacy and limitations of remote collision detection devices
- Determining collision risk levels associated with potential high avian-use habitats
- Monitoring and reporting over the long term



© JERRY LIGUORI

FIGURE 2.5: APLIC, EPRI, and CEC are three organizations that provide some funding for research on avian/power line interactions.



CHAPTER 3

Avian Regulations and Compliance

IN THIS CHAPTER

Overview of Existing Laws and Policies

Permit Requirements

Most native North American birds are protected by the Migratory Bird Treaty Act. Additional statutes provide further protection for bald and golden eagles (*Haliaeetus leucocephalus* and *Aquila chrysaetos*) and birds that are threatened or endangered. This chapter describes United States' and Canada's federal regulations that protect these birds, their habitat, and the corresponding conservation and permitting measures.

OVERVIEW OF EXISTING LAWS AND POLICIES

UNITED STATES Migratory Bird Treaty Act

The Migratory Bird Treaty Act of 1918 (MBTA) (16 U.S.C. 703–712) is the legal cornerstone of migratory bird conservation and protection in the United States. It is a strict liability statute, meaning that proof of intent is not required in the prosecution of a taking (injuring or killing) violation. Most actions that result in *taking* or possessing a protected species, its nest, parts, and/or eggs are violations.

The MBTA states: “Unless and except as permitted by regulations...it shall be unlawful at any time, by any means, or in any manner to pursue, hunt, *take*, capture, kill... possess, offer for sale, sell...purchase...ship, export, import...transport or cause to be transported...any migratory bird, any part, nest, or eggs of any such bird, or any product ...composed in whole or in part, of any such bird or any part, nest, or egg thereof...”

Generally speaking, the MBTA protects the majority of birds that nest in North America (50 CFR 10.13). As of 2012 there were 1,007 bird species on the list of migratory bird species protected under the MBTA. The list includes waterfowl, shorebirds, seabirds, wading birds, raptors, and songbirds. The 1972 MBTA amendment extended protection to birds of prey—eagles, hawks, falcons, and owls—and to corvids, such as crows and ravens. However, the MBTA does not protect non-migratory upland game birds (such as grouse and quail) or introduced species such as house (English) sparrows (*Passer domesticus*), European starlings (*Sturnus vulgaris*), rock pigeons (common/feral pigeons, *Columba livia*), monk parakeets (*Myiopsitta monachus*), and 121 other less commonly encountered species that have been excluded from protection by the MBTA (USFWS 2005a [70 Fed. Reg. 49, 15 March 2005]).



FIGURE 3.1: The Migratory Bird Treaty Act of 1918 is the legal cornerstone of bird protection in the United States, protecting more than 1,000 North American bird species such as this cedar waxwing (*Bombycilla cedrorum*).

© BILL THOMPSON, USFWS

An individual, which can mean a corporation or other organization, who violates the MBTA may be fined up to \$15,000 and/or imprisoned for up to six months for a misdemeanor conviction. An individual who knowingly *takes* any migratory bird with the intent to sell, offer to sell, barter, or offer to barter such bird or who knowingly sells, offers for sale, barter, or offers to barter any migratory bird is subject to a felony violation with fines of up to \$250,000 and/or imprisonment for up to two years. The MBTA has no provision for permitting incidental or accidental take.

Federal agencies taking actions that have, or are likely to have, a measurable negative effect on migratory bird populations are directed by Executive Order I3186 (3 CFR 200I; Office of the President 200I. [66 Fed. Reg. 11, 17 January 200I]) to develop and implement a memorandum of understanding (MOU) with the U.S. Fish and Wildlife Service (USFWS) that shall promote the conservation of migratory bird populations.

This includes federal agencies' power line infrastructure-related collisions and electrocutions of protected birds. To date (2012), MOUs have been signed by the Department of Defense, Department of Energy, U.S. Forest Service, National Park Service, Bureau of Land Management, Minerals Management Service/Bureau of Ocean Energy Management, and the Federal Energy Regulatory Commission, with others under development.

Bald and Golden Eagle Protection Act

The Bald and Golden Eagle Protection Act of 1940 (BGEPA) (16 U.S.C. 668–668d) provides additional protection to these eagle species. If a proposed project or action would occur in areas where nesting, feeding, or roosting eagles occur, then utilities may need to take additional conservation measures to achieve compliance with the BGEPA.

The BGEPA prohibits the take, possession, sale, purchase, barter, offer to sell, purchase, or barter, transport, export or import, of any bald or golden eagle, alive or dead, including any part, nest, or egg, unless allowed by permit ([16 USC 668(a)]. *Take* under this statute is defined as “to pursue, shoot, shoot at, poison, wound, kill, capture, trap, collect, molest or disturb” (50 CFR 22.3). *Programmatic take* is defined as “take that (1) is recurring, but not caused solely by indirect effects, and (2) occurs over the long-term and/or in a location or locations that cannot be specifically identified” (50 CFR 22.26). *Disturb* is defined as “to agitate, or bother a bald or golden eagle to a degree that causes, or is likely to cause, based on the best scientific information available, (1) injury to an eagle, (2) a decrease in its productivity, by substantially interfering with normal breeding, feeding, or sheltering behavior, or (3) nest abandonment, by substantially interfering with normal breeding, feeding, or sheltering behavior” (50 CFR 22.3). Violators may be fined up

to \$100,000 and/or imprisoned for up to one year. Individuals with subsequent convictions or who commit intentional *takes* face penalties of up to \$250,000 and/or two years imprisonment.

The BGEPA has been amended to provide a permit for non-purposeful *take*, including *take resulting in disturbance* and limited *take resulting in mortality* that may occur as a result of otherwise lawful activities, provided the breeding populations are stable or increasing. Because there are no breeding populations in the eastern United States that can sustain *take*,

the USFWS will not authorize *take* for golden eagles east of approximately 100° west longitude, except for *take* of nests for safety emergency situations (USFWS 2009a).

Endangered Species Act

The Endangered Species Act of 1973 (ESA) (16 U.S.C. 1531–1544) protects the United States' native plants and animals that are in danger of becoming extinct and may also protect their habitats. Federal agencies are directed to use their authority to conserve listed and candidate⁶ species and to ensure that their actions do not further jeopardize these species or adversely modify designated critical habitat for them. The law is administered by the USFWS and the National Marine Fisheries Service (NMFS). The USFWS has responsibility for terrestrial and freshwater organisms, while the NMFS oversees endangered marine life. These two agencies work with other agencies to plan or modify federal projects to minimize project impacts on listed species and their habitats. Protection is also gained through USFWS' financial and technical assistance partnerships with states, tribes, and private landowners.

Section 9 of the ESA makes it unlawful for a person to *take* a listed species. *Take* under the ESA is defined as "...to harass,⁷ harm,⁸ pursue, hunt, shoot, wound, kill, trap, capture, or collect or attempt to engage in any such conduct." The ESA authorizes the USFWS to issue Incidental Take Permits (ITP) for *take* resulting from otherwise legal activity.

Section 10 of the ESA allows Habitat Conservation Plans (HCP) for the con-



© NORMANDEAU ASSOCIATES, INC.

FIGURE 3.2: Habitat Conservation Plans help landowners incorporate conservation measures for species, such as the wood stork (*Mycteria americana*), into their development plans.

⁶ *Candidate* species are those in decline which may be added to the list of threatened and endangered species in the near future.

⁷ Harass is defined as an intentional or negligent act or omission, which creates the likelihood of injury to wildlife by annoying it to such an extent as to significantly impair normal behavioral patterns including breeding, feeding, or sheltering (50 CFR 17.3).

⁸ Harm is defined as an act which actually kills or injures wildlife. Such acts may include significant habitat modification or degradation when it actually kills or injures wildlife by significantly impairing essential behavioral patterns including breeding, feeding, or sheltering (50 CFR 17.3).

struction and management of facilities, e.g., transmission lines, on private lands that are used by endangered species. These plans help landowners incorporate conservation measures into their land and/or water development plans. Landowners who develop and implement HCPs can also receive ITPs that allow their activities to proceed with authorization for limited *take*.

State Policies and Regulations

States have additional bird protection regulations. A utility should consult with its respective state wildlife agency to determine whether more regulations apply and if permits are required.

CANADA

Migratory Birds Convention Act

The Migratory Birds Convention Act (MBCA) of 1917 and amended 1994 (1994, c.22) is Canada's equivalent of the United States' MBTA (1918), which provides legal protection for migratory birds. One notable exception is raptors, which are protected by provincial and territorial wildlife acts instead of MBCA. The MBCA satisfies the terms of the Migratory Birds Convention of 1916, when both countries recognized concerns about overhunting waterfowl and shorebirds. The MBCA recognizes three classifications of protected birds: migratory game birds, migratory insectivorous birds, and migratory non-game birds. It further lists them by family and gives examples.

In Canada, the MBCA is administered by the Wildlife Enforcement Division of Environment Canada in cooperation with provincial and territorial governments. Enforcement of the Act is made in concert with the Canadian Wildlife Service (CWS), Royal Canadian Mounted Police, and provincial and territorial enforcement authorities.

The MBCA and its associated regulations state that "No person shall hunt a migratory bird except under authority of a permit," and "Subject to subsection 5(9), no person shall (a) disturb, destroy, or *take* a nest, egg, nest shelter, eider duck shelter or duck box of a migratory bird, or (b) have in his possession a live migratory bird, or a carcass, skin, nest or egg of a migratory bird."

Individuals, which includes corporations, who violate the MBCA and associated regulations may be subject to a fine of up to \$300,000 and/or six months imprisonment. Upon summary conviction or upon indictment, fines of up to \$1,000,000 and/or two years imprisonment may be applied.



FIGURE 3.3: Canada geese (*Branta canadensis*) are protected by both the Migratory Bird Treaty Act and Canada's equivalent, the Migratory Birds Convention Act.

Species at Risk Act

The Canadian Species at Risk Act (SARA) was enacted in 2003. The objective of SARA is to protect native species from extinction, ensure measures are taken for the recovery of threatened or endangered species, and encourage best management practices for maintaining healthy populations.

SARA adopted the Committee on the Status of Endangered Wildlife in Canada (COSEWIC) as an advisory body to assess potentially at-risk wildlife species, identify existing and potential threats to the species, and classify the status of the species (i.e., extinct, extirpated, endangered, threatened, of special concern, or not currently at risk). Established in 1977, COSEWIC is an independent committee of wildlife experts and scientists from federal, provincial and territorial governments, universities, and non-government organizations that uses the best available science to support its recommendations. Under SARA, the government of Canada will take COSEWIC's designations into consideration when establishing the legal list of wildlife species at risk (COSEWIC 2009).

SARA states that “No person shall kill, harm, harass, capture or *take* an individual of a wildlife species that is listed as an extirpated species, an endangered species or a threatened species.” However, SARA does make allowance for the incidental *take* of animals through the issuance of permits (similar to the ESA in the United States).

Provincial Policy and Regulations

Federal and provincial governments have worked together to develop complementary policy and programs to protect species at risk. For example, the Alberta Wildlife Act and Regulations seek to protect wildlife whereby “a person shall not hunt wildlife unless the person holds a licence authorizing

the person, or is authorized by or under a licence, to hunt wildlife of that kind.” The legislation also states that “a person shall not wilfully molest, disturb or destroy a house,⁹ nest or den of prescribed wildlife” where wildlife is defined as “big game, birds of prey, fur bearing animals, migratory game birds, non game animals, non-licence animals and upland game birds.” Similarly, other provinces have enacted legislation for the protection of wildlife, including birds.

INTERNATIONAL POLICIES AND AGREEMENTS

Since 2000, there has been an increasing international awareness of the issue of bird collisions for certain species. International conventions and policies (see CMS 2011a) that are relevant to bird collisions include:

- Agreement on the Conservation of African-Eurasian Migratory Waterbirds (AEWA)
- Convention on Biological Diversity (CBD)
- Ramsar Convention on Wetlands, List of Wetlands of International Importance
- Convention on the Conservation of Migratory Species of Wild Animals (CMS)
- MOU on the Convention of Migratory Birds of Prey in Africa and Eurasia
- MOU on the Conservation and Management of the Middle-European Population of the Great Bustard
- Convention on the Conservation of European Wildlife and Natural Habitats (Bern Convention)
- Various European Union Directives

These agreements have resulted in research, reviews, and guidance on bird collisions that may provide some further insight into bird collisions.

⁹ The term “house” includes artificial structures such as bird boxes and nesting platforms.

PERMIT REQUIREMENTS

UNITED STATES

Federal and state permits may be required for activities that may affect species protected by the MBTA, BGEPA, ESA, or state laws. For species protected by the MBTA, utilities are encouraged to contact their regional USFWS Migratory Bird Permit Office and their state wildlife agency to identify permit requirements and, if necessary, obtain permit applications. For species protected by the ESA and BGEPA, utilities must contact their USFWS Ecological Services field office.

Migratory Bird Permits

Migratory bird permits are issued by the regional USFWS Migratory Bird Permit Offices. Permits are issued for falconry, raptor propagation, scientific collection, rehabilitation, conservation education, migratory game bird propagation, salvage, *take* of depredated birds, taxidermy, waterfowl sale and disposal, and special purpose. Annual reporting to the USFWS is required as a condition of each permit. Policy for migratory bird permits is developed by the Division of Migratory Bird Management. The regulations governing migratory bird permits can be found in 50 CFR part 13, General Permit

Procedures, and 50 CFR part 21, Migratory Bird Permits.

In 2003, the USFWS issued a memorandum clarifying the definition of *take* under the MBTA as it applies to active nests (nests containing eggs or young). Under the MBTA, the collection, possession, and transfer of inactive bird nests requires a permit, but the destruction of nests that do not contain eggs or birds is permissible. This does not apply to eagles or species listed by the ESA, whose active and inactive nests are protected. The memo also stated that the USFWS may issue permits for the removal of occupied nests when public safety is at risk (see 50 CFR 21.27).

Bald and Golden Eagle Permits

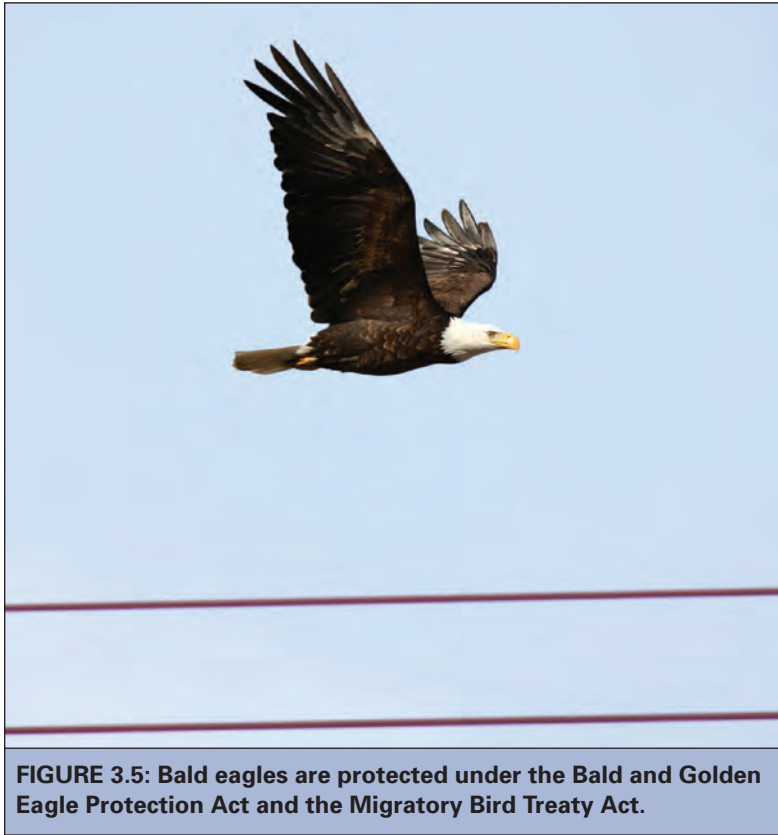
BGEPA permits are administered by the regional USFWS Migratory Bird Permit Offices in coordination with the Division of Migratory Bird Management's Washington, D.C. office and the local Ecological Services field office where an eagle *take* might occur.

Under BGEPA (50 CFR parts 22.26 and 22.27), the USFWS can issue permits to *take* bald eagles and golden eagles or their nests, where the *taking* is associated with, but not the purpose of, the activity and cannot practically be avoided. Permits may be authorized for non-purposeful *take*, which includes *take resulting in disturbance* or *limited take resulting in mortality* provided the breeding populations are stable or increasing. USFWS will not issue golden eagle *take* permits east of the 100° meridian (see [BGEPA discussion](#) on page 22).

USFWS may also issue permits for programmatic *take* (e.g., recurring *take* for an entire power line over a specified amount of time) or for individual *take* (e.g., for disturbance due to one-time construction of a power line where the location of the *take* and when it will occur are known). *Programmatic take* permits may be issued to entities, such as electric utilities or transportation providers, that may currently *take* eagles in the course of



FIGURE 3.4: Most songbirds, such as these horned larks (*Eremophila alpestris*), are protected by the Migratory Bird Treaty Act.



© JERRY LIGUORI

FIGURE 3.5: Bald eagles are protected under the Bald and Golden Eagle Protection Act and the Migratory Bird Treaty Act.

otherwise lawful activities but who can work with the USFWS to develop and implement advanced conservation practices (ACPs). ACPs are defined as “scientifically supportable measures that are approved by the Service and represent the best available techniques to reduce eagle disturbance and ongoing mortalities to a level where remaining *take* is unavoidable” (50 CFR 22.3).

The regulations are intended to provide a mechanism—under carefully considered circumstances—where non-purposeful *take* of bald and golden eagles can be legally authorized. However, BGEPA provides the Secretary of Interior with the authority to issue eagle *take* permits only if it is able to determine that the *take* is compatible with eagle conservation. This must be “...consistent with the goal of increasing or stable breeding populations.”

Regulation establishes the issuance of permits for removing eagle nests where (1) necessary to alleviate a safety emergency to people or eagles, (2) necessary to ensure public health and safety, (3) the nest prevents the use of a human-engineered structure, or (4) the activity or mitigation for the activity will provide a net benefit to eagles (50 CFR 22.27). Only inactive nests may be *taken* except in the case of safety emergencies. Inactive eagle nests are defined by the continuous absence of any adult, egg, or dependent young at the nest for at least 10 consecutive days leading up to the time of *taking* the nest.

Special Purpose or Salvage or Miscellaneous Permit

In compliance with federal regulations, utilities may need certain permits to handle or “possess” injured or dead birds found along power lines. Salvaging and possessing carcasses of birds protected under the MBTA requires a Federal Special Purpose or Salvage or Miscellaneous Permit (50 CFR 21.27). This permit allows the burial or incineration of migratory birds found dead on a utility property or temporary possession for transporting to a suitable disposal location, rehabilitation facility, repository, or wildlife pathology laboratory. Permit conditions may vary but if the bird is a federally endangered or threatened species or eagle, most permits require the USFWS to be notified within 48 hours of discovery of the carcass. Depending on permit requirements, a quarterly and/or an annual report must be submitted to the USFWS regional permit office.

Endangered Species Act Consultation, Incidental Take Permit (ITP), and Habitat Conservation Plan (HCP)

When utilities propose the construction of, for example, power generation or transmission facilities where a federal nexus exists (i.e., on federal lands, with federal funding, or requiring federal authorization or permits), they

must first consult with the USFWS through Section 7 of the ESA if any threatened or endangered species may be at risk. Before initiating an action, the federal agency owning the land or providing the funding or the non-federal permit applicant (e.g., an electric utility) should ask the USFWS to provide a list of threatened, endangered, proposed, and candidate species and designated critical habitats that may be present in the project area. The USFWS has developed a handbook that describes the consultation process in detail (USFWS and NMFS 1998). Based on a Biological Assessment, an ITP may be issued under Section 7 of the ESA.

When non-federal activities (i.e., lacking a federal nexus) will or may *take* threatened or endangered species, an ITP is required under Section 10 of the ESA. Approval of an ITP issued in conjunction with an HCP requires the Secretary of the Interior to find, after an opportunity for public comment, that among other things, the *taking* will be incidental and that the applicant will, to the maximum extent practicable, minimize and mitigate the impacts of such *taking*. An HCP must accompany the application for an ITP. The HCP associated with the permit is to ensure that conservation measures are adequate for avoiding jeopardy to the species or adversely modifying critical habitat. Information about consultations and HCPs can be obtained by contacting the local USFWS Ecological Services field office.

CANADA

Both MBCA and SARA provide for permitting and authorization of incidental *take* of migratory birds and species at risk. However, for MBCA, the Canadian government, through

the CWS, has declared that they will not develop the permitting system; instead they recommend that companies use due diligence to prevent incidental impacts to migratory birds through best management practices.

SARA does provide for incidental harm to a species or destruction of its critical habitat under carefully controlled circumstances provided the activity does not jeopardize the survival or recovery of the species. These provisions include permits (three-year duration) or agreements (five-year duration). These authorizations are tied to strictly prescribed conditions. The government continues to work with stakeholders to develop operational policies to better implement SARA.

The requirement to protect critical habitat for migratory birds only applies in federal lands such as national parks, national wildlife areas, and bird sanctuaries. For critical habitat located in federally protected lands, the prohibition on destruction of this habitat applies automatically once the Environment Minister posts a description of the critical habitat in the Canada Gazette (typically within 90 days after the recovery strategy/action plan is posted to the SARA Public Registry).

The Environment Minister can recommend that the Cabinet protect a migratory bird species and/or the critical habitat of a species not on federal land if there is reason to believe the province or territory is not sufficiently protecting the species. However, the decision by the Cabinet to order protection is discretionary. There is also a species and habitat harm exemption clause in SARA for activities that have been authorized by other permits or agreements. This clause has not been implemented to date (2012).



CHAPTER 4

Understanding Bird Collisions

IN THIS CHAPTER

- Susceptibility of Birds to Power Line Collisions
- Identifying Collision Mortality
- Variability in Reported Mortality Rates
- Biological Significance of Collision Mortality
- Biological Characteristics Influencing Avian Collision Risks
- Environmental Conditions Influencing Avian Collision Risks
- Engineering Aspects Influencing Avian Collision Risks

Understanding the nature of bird collisions is essential for minimizing and mitigating them. This chapter presents what is known about bird collisions including the susceptibility of certain species, variability in reported mortality rates, biological significance of collision mortality, and the biological, environmental, and engineering factors that influence collision risk.

Some bird species have a greater collision risk than others. Because of the need for power lines to deliver electricity, engineering design requirements, and potential interaction of birds with power lines, collisions cannot be eliminated, but they can be reduced. The understanding of bird collisions has grown since 1994 and revolves around the following principles:

- Exposure to collisions is largely a function of behavior. Specific behaviors (such as flushing, courtship displays, and aerial hunting) may distract birds from the presence of power lines.
- Exposure is increased for birds that make regular and repeated flights between nesting, feeding, and roosting areas in proximity to power lines.
- Susceptibility to collisions is partially a function of wing and body size and vision. Larger, heavy-bodied birds with short wing spans and poorer vision are more susceptible to collisions than smaller, lighter-weight birds with relatively large wing spans, agility, and good vision.
- Environmental conditions (such as inclement weather and darkness) may distract birds from the presence of power lines or obscure their visibility.
- Engineering aspects, including design and placement, can increase or decrease the exposure for collisions.

SUSCEPTIBILITY OF BIRDS TO POWER LINE COLLISIONS

Summaries of studies on birds' susceptibility to collisions have primarily come from Europe (see Bevanger 1998; Janss 2000; Rubolini et al. 2005). Based on the Bevanger (1998) summary of risk, the orders of birds reported to be most susceptible to collisions included:

- Gaviformes (e.g., loons)
- Podicipediformes (e.g., grebes)
- Procellariiformes (e.g., shearwaters, albatross, petrels)
- Pelecaniformes (e.g., pelicans, cormorants)
- Ciconiiformes (e.g., storks, ibis, herons)
- Anseriformes (e.g., ducks, geese)
- Falconiformes (e.g., hawks, eagles)
- Galliformes (e.g., grouse)
- Gruiformes (e.g., rails, cranes)
- Charadriiformes (e.g., gulls, terns)

- Apodiformes (e.g., swifts)
- Columbiformes (e.g., pigeons, doves)
- Strigiformes (e.g., owls)
- Passeriformes (e.g., song birds)

The reasons for this susceptibility are functions of species characteristics, in particular the birds' body size, weight, wing shape, flight behavior, and nesting habits (see *Biological Characteristics Influencing Avian Collision Risks* on page 36). For example, literature shows that, in general, birds of prey are good fliers, have the ability to avoid obstacles, and are not prone to collisions. It is when they are engaged in certain activities (e.g., territorial defense, pursuing prey) that their collision risk increases (see Harness et al. 2003; Olendorff and Lehman 1986).

IDENTIFYING COLLISION MORTALITY

Reporting bird injuries and mortalities is part of the U.S. Fish and Wildlife Service (USFWS) permit requirements (see [Chapter 3](#)) and permits are an element of utility Avian Protection Plans (APPs; see [Chapter 7](#)). In order to report mortalities correctly, the affected species and the cause (collision or electrocution) needs to be properly identified. Field guides can be used to identify the bird species, and a guide for identifying raptor remains is also

available (CEC 2005). The U.S. Geological Survey's National Wildlife Health Center also provides information and technical assistance for identifying bird carcasses (USGS 2011). See [Appendix E](#) for resources.

Table 4.1 lists the typical damage evident in bird carcasses from collision injuries. Electrocution injuries often occur as burn marks on the feathers and feet (see APLIC 2006). Collisions can also lead to electrocutions

TABLE 4.1: Typical evidence of bird injuries or mortalities from power line collisions.*

Evidence	Description
Predominant bone fractures	Fractured wings, legs, shoulder bones, vertebra, or skull; torn off limbs
Damage to plumage	Mechanical damage, such as torn off or broken feathers
Skin injuries	Skin torn open or off, and open muscle, sinew, and bone tissue visible; power line may leave imprint in skin where the bird struck the line; necropsy may reveal internal bleeding and bruising
Secondary damage to extremities	Limited areas of infection at open wounds, bones, sinews, and muscles
General condition of injured birds	State of shock; handicapped by injuries and secondary damage

* Source: Adapted from BirdLife International (2003)

(called collision-electrocutions) if the bird's size is sufficient to make simultaneous contact with two phase conductors or with a phase

conductor and grounded equipment, or if the collision causes two lines to slap together or get close enough to cause an electric arc.

VARIABILITY IN REPORTED MORTALITY RATES

It is difficult to extrapolate collision risk from one study and apply it to other power lines or compare it with other studies because of site-specific conditions and varying study methods and metrics. Likewise, many collision studies have been conducted in high risk areas and would not be applicable to lower risk areas. Numerous authors have summarized collision mortality with power lines (e.g., Faanes 1987; Bevanger 1998; Alonso and Alonso 1999; Rubolini et al. 2005; and Jenkins et al. 2010) and report mortality rates ranging from no birds killed to several hundred birds killed along a given segment of line per year. The California Energy Commission (CEC) study

(Hunting 2002) provides a summary of collision mortality rates per unit area per distance. Reported mortality rates are highly variable and do not lend themselves to extrapolation to other lines because of site- and study-specific differences in:

- Species involved, such as ducks and sandhill cranes (*Grus canadensis*)
- Habitats, such as wetlands and agriculture
- Time periods and sampling regimes, such as single seasons versus multiple seasons
- Weather conditions, such as fog, wind, etc.
- Sampling biases, such as scavenger removal rates and searcher efficiency
- Types of power lines

Another limit to extrapolating bird/power line collision mortality estimates is the tendency to select worst-case scenarios as case studies (e.g., Koops 1987; Erickson et al. 2001; Manville 2005a). The CEC study (Hunting 2002) points out the difficulty in generalizing collision rates, and Bevanger (1999) provides an excellent summary of the



FIGURE 4.1: Collision risk is highly variable among species, with heavy-bodied birds, such as this common loon (*Gavia immer*), being more vulnerable because they cannot readily maneuver.

© JERRY LIGUORI

Bibliographies of Collision Literature

Appendix A of this manual includes the literature cited and a bibliography of collision literature. An annotated bibliography of early collision literature was provided by Avery et al. (1980). In addition, the California Energy Commission hosts a searchable database on collisions: *On-Line Annotated Bibliography of Avian Interactions with Utility Structures* (CEC 2011).

methodological issues in calculating these rates. For example, Faanes' (1987) calculation of 125 collisions/kilometer(km)/year (0.62 miles[mi]/year) for a line near a North Dakota wetland with abundant waterfowl during migration periods has been referenced by others including Bevanger (1999) and Erickson et al. (2005). Janss and Ferrer (2000) calculated collision rates of "one of the densest breeding populations of the great bustard (*Otis tarda*) in Spain," and for a large wintering population of common cranes (*Grus grus*) feeding in grain fields. Extrapolations from these studies could lead to exaggerated overestimates.

Adding to the difficulty in providing an overall assessment of collision mortality is that bird collisions do not usually cause power outages and consequently are not usually discovered. On the other hand, electrocutions are more likely to cause power outages and be reported (see APLIC 2006). To generate collision estimates for a particular power line, power line segments have to be selected randomly for mortality monitoring and should represent a diversity of habitats. Collision mortality can be relatively high or low depending upon the species, habitat, and the local circumstances. [Appendix B](#) provides recommendations for collision monitoring studies.

BIOLOGICAL SIGNIFICANCE OF COLLISION MORTALITY

Understanding the biological significance of collision mortality is necessary for developing proper reduction strategies. Collision mortality may have significance from social, wildlife policy, and biological points of view. Social and wildlife policy aspects relate to how the public and wildlife agencies consider collision mortality. The biological aspects relate to how the mortality affects bird populations. The social or wildlife policy assumption of significance is not necessarily biologically significant.

From a biological perspective, significance evaluates whether collision mortality will affect the viability of a species' population. Biological significance results from an influence that significantly affects the ability of a species' population to sustain itself or increase its size.

This definition is used by population biologists to understand the influence of an adverse effect on a particular population or species. During site evaluation studies, utility biologists need to be aware of the possible impacts to rare species and to determine if the line would create a biologically significant risk as well as significant risk from a wildlife policy perspective (see [Chapter 3](#)).

Drewitt and Langston (2008) conclude that few studies of bird collisions with power lines show that collisions are biologically significant, which means individual losses from collision mortality are unlikely to affect large and robust populations. As an independent mortality factor, the effect of power line collisions on bird populations is generally thought to be compensated for in populations that have high reproductive rates (Bevanger 1998).

Biologically significant risk from collisions may occur in a population that is so small



FIGURE 4.2: Because of their higher reproductive rates, common bird species are generally at less risk of population effects from power line collisions.

that the loss of a few individuals may impact local, rare, or endangered populations (Crowder 2000). Power line collisions may be significant to very small and/or declining populations, as they may not be capable of compensating for this loss (Bevanger 1998). Drewitt and Langston (2008) note that low reproductive rates and small populations of some species may further contribute to the likelihood of population effects. In addition, there are examples where collision mortality has occurred locally and concern has been expressed. Although not a federally endangered species, recent studies of sandhill cranes in Nebraska have shown that local populations can be affected by collision mortality (Murphy et al. 2009). Collisions during spring migration stopovers at major night roosts along the Platte River in Buffalo County, Nebraska, have been historically high near two 69-kilovolt (kV) transmission lines. The Newell's shearwater (*Puffinus auricularis newelli*), an endangered species in Hawaii, is an example of a species with a relatively small and restricted population that is threatened by multiple factors including power line collisions (Podolosky et al. 1998). Other threats include ground nest predation by dogs, cats, rats, pigs, and mongooses; collisions with buildings, cars, and other objects; and attraction to lights that may disorient them and cause them to fly around the light until they fall from exhaustion. Power line collisions appear to be a major contributor to the threats to Newell's shearwater's survival (Podolosky et al. 1998; Day et al. 2003; R. Podolosky, pers. comm.).

Outside North America, collision mortality is considered biologically significant for these species with low population numbers:

- Red-crowned cranes (*Grus japonensis*) in Japan (Archibald 1987, cited in Crowder 2000)
- Wattled cranes (*Bucconas carunculatus*) in South Africa (Van Rooyen and Ledger

1999, cited in Crowder 2000)

- Capercaillie (*Tetrao urogallus*) in Norway (Bevanger 1995; Bevanger and Broseth 2004)
- Dalmatian pelicans (*Pelecanus crispus*) in northern Greece (Crivelli et al. 1988, cited in Drewitt and Langston 2008)
- Bonelli's eagle (*Aquila fasciata*) in Spain (Mañosa and Real 2001)
- Sarus crane (*Grus antigone*) in India (Sundar and Choudury 2005)
- Eagle owl (*Bubo bubo*) in Sweden (Herren 1969)
- Mute swans (*Cygnus olor*) in the United Kingdom (Kelly and Kelly 2005)

In the United States, collision mortality from power lines is considered biologically significant for two species with small populations: the whooping crane (*Grus americana*) and the California condor (*Gymnogyps californianus*).

WHOOPING CRANE

Losses of wild and reintroduced (or experimental) whooping cranes to power line collisions have been reported (Crowder 2000; Brown et al. 1987; Morkill and Anderson 1991; Stehn and Wassenich 2007). The one natural wild population, the Aransas-Wood Buffalo Population (AWBP), has been subjected to significant natural causes of mortality such that additional collision mortality is viewed as a threat to the species. The loss of 57 cranes (21.4% of the flock of 266) that died of starvation and infectious disease in the 12 months following spring 2008 (34 between spring and fall, 23 during the winter) was a serious setback (T. Stehn, pers. comm.). The additional loss of more than 10 birds per year for any reason could destabilize this species' recovery. However, the population has shown resilience with 279 whooping cranes at the Aransas National Wildlife Refuge in the spring of 2011 (T. Stehn, pers. comm.) compared to 247 in the spring of 2009.



FIGURE 4.3: The United States' population of endangered whooping cranes has had such significant mortality from natural causes that additional power line collision mortality is now viewed as a threat to the species.

© USFWS

The actual percentage of whooping crane mortality caused by collisions with power lines is hard to extrapolate for the AWBP because monitoring the small population during migration over such a large area (Figure 4.4)¹⁰ is so difficult. In the 1980s, two of nine radio-marked juvenile whooping cranes in the AWBP died within the first 18 months of life as a result of power line collisions; that is 33% of total post-fledging losses ($n = 6$) of the radio-marked birds during the study (Kuyt 1992). Five of 13 known causes of mortality (38%) for the AWBP between April and November from 1950 to 1987 resulted from collisions with power lines (total mortality from all causes equaled 133 cranes) (Lewis 1992).

Collisions have been reported in other

whooping crane populations as well. In the non-migratory Florida population, 20 out of 166 cases with known causes of mortality (12%) were from collisions with power lines, and in the migratory Wisconsin population, 3 out of 18 mortalities (17%) were from collisions with power lines (Stehn and Wassenich 2007). From 1950 to 2008, out of 508 fledged whooping cranes that have died, only 44 (8.7%) of the carcasses were recovered (C. Strobel, USFWS, unpubl. data). Of the 44 carcasses recovered, no cause of death could be determined for 17. Of the remaining 27 carcasses where a cause of death was established, 9 (33%) were from power line strikes and 18 (67%) were from other causes (e.g., disease, predators, and shooting).

¹⁰ The whooping crane migration corridor is 322 km (200 mi) wide and extends 4,023 km (2,500 mi) from Wood Buffalo National Park in the Alberta and Northwest territories in Canada to the Aransas National Wildlife Refuge on the Gulf Coast of Texas (see Stehn and Wassenich 2007).

CALIFORNIA CONDOR

The federally endangered California condor was rescued from extinction when the last remaining wild individuals were captured

from the mountains of southern California in 1987 to establish a captive breeding and reintroduction program. In 1991, reintroduction of captive-bred individuals began in select areas of the southwestern United States. As of December 2011, the total wild population of California condors was 210 individuals (NPS 2011). Reintroduced individuals from the captive breeding program have come into contact with power lines and collision mortality has occurred. For example, in a six-month period, three of eight condors that died in the wild died after colliding with power lines (D. Pearson, pers. comm.).

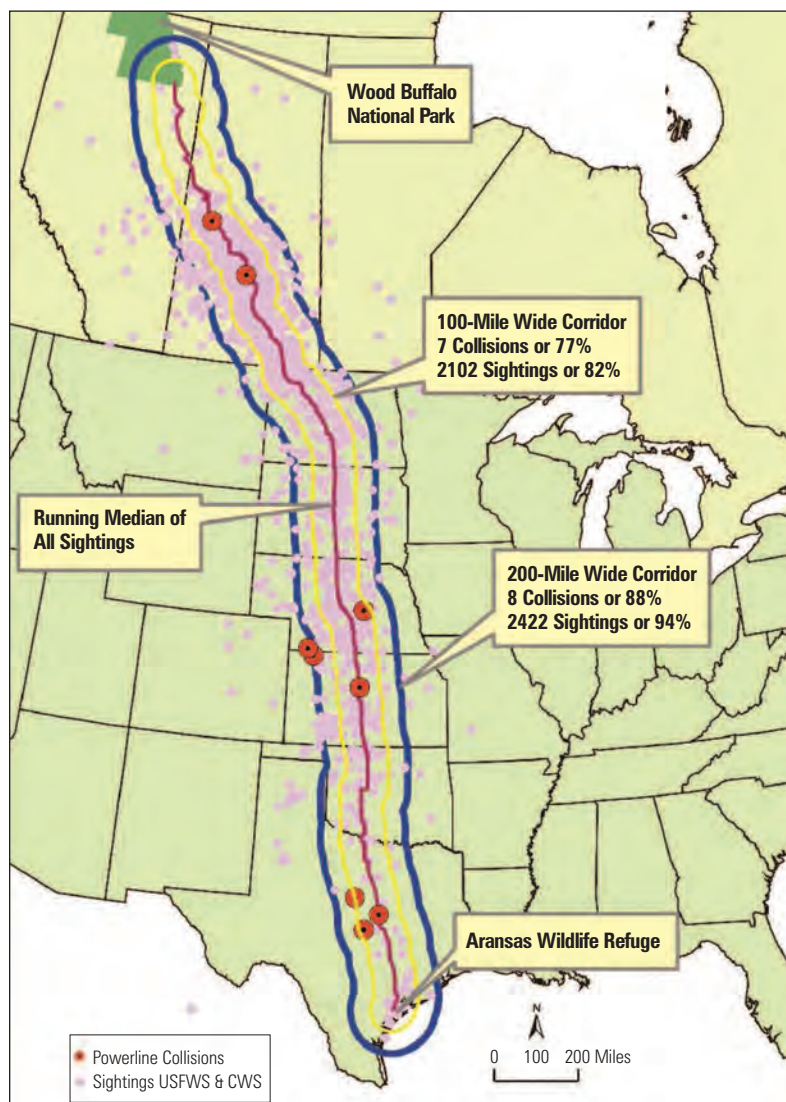


FIGURE 4.4: Whooping crane migration corridor in North America (2005 data from Stehn and Wassenich 2007).

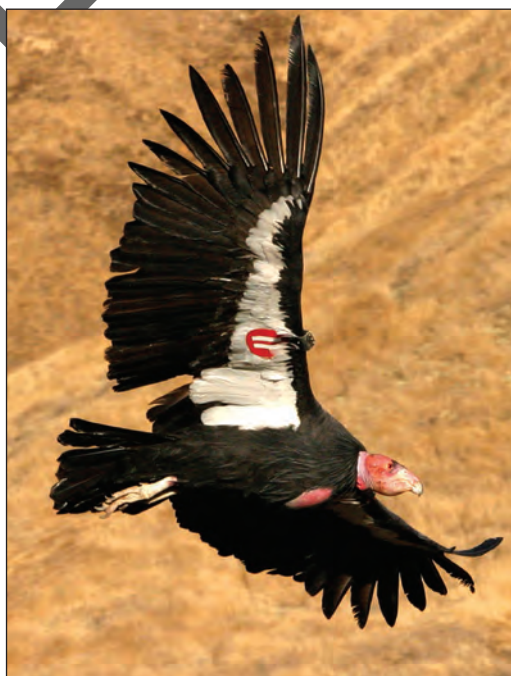


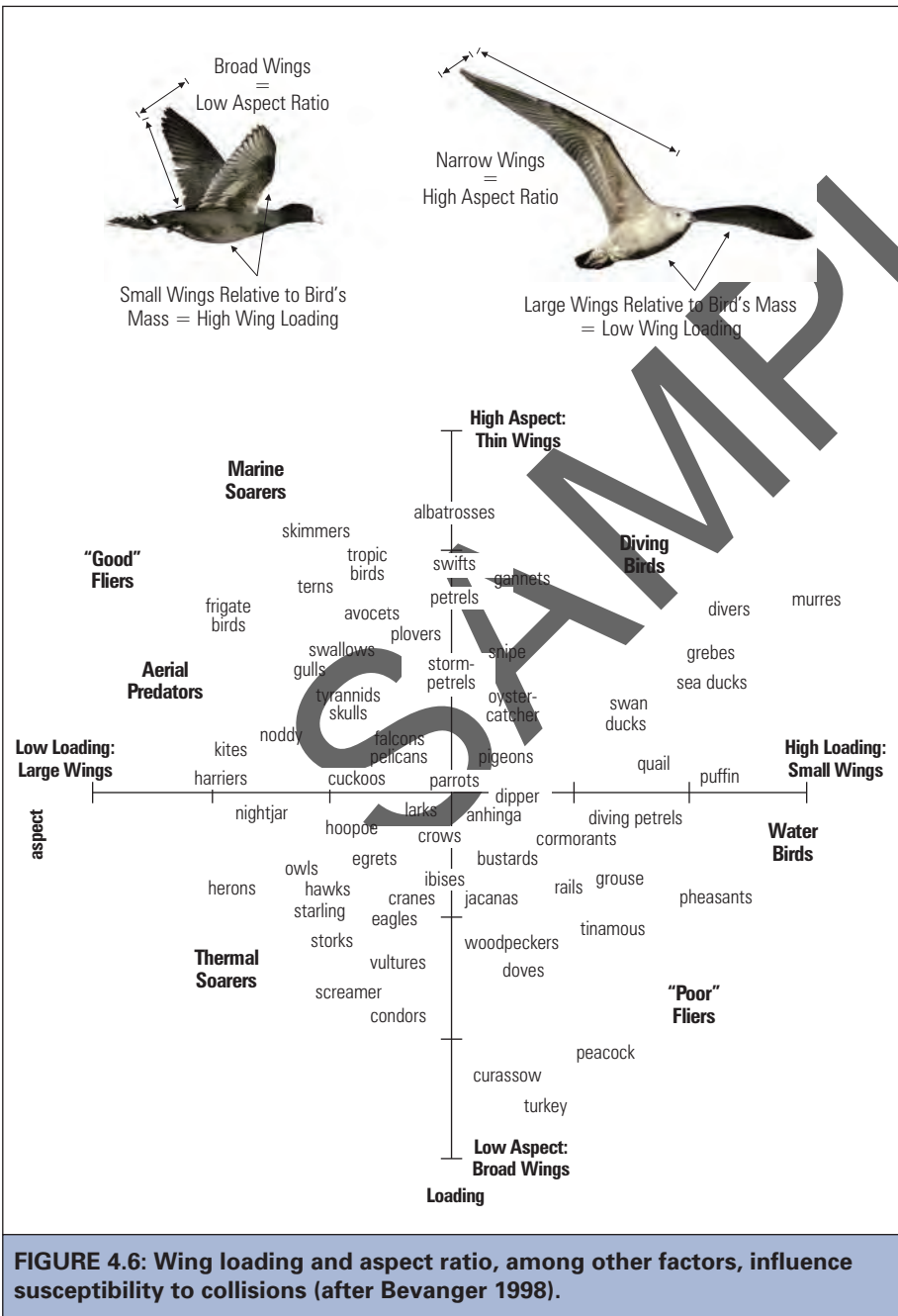
FIGURE 4.5: Collision mortality has occurred with the expansion of the reintroduced population of the endangered California condor.

4

BIOLOGICAL CHARACTERISTICS INFLUENCING AVIAN COLLISION RISKS

Different bird species have different collision risks based on their biology, behavior, habitat use, and inherent abilities to avoid risk (e.g., Savereno et al. 1996) (see *Susceptibility of Birds to Power Line Collisions*, page 30). A number of biological characteristics influence the susceptibility of species to collisions with power lines:

- Body size, weight, and maneuverability
- Flight behavior
- Vision
- Age and sex
- Health
- Time of day and season
- Habitat and habitat use



Knowing what avian species are involved, when they are present, and how they use the habitat along a power line route will help to estimate risk.

BODY SIZE, WEIGHT, AND MANEUVERABILITY

Several studies of collision vulnerability have addressed the relationship between bird size and maneuverability (e.g., Bevanger 1994, 1998; Janss 2000; Crowder and Rhodes 2002; and Rubolini et al. 2005). They classified birds based on weight and with these characteristics quantified wing loading (the ratio of body weight to wing area) and wing aspect ratio (ratio of the square of the wing span to the wing area) (Figure 4.6). Using Rayner's characterization (Rayner 1988), bird species were grouped according to the relationship of wing loading and wing aspect ratio and analyzed for collision susceptibility (Bevanger 1998). He developed six categories: poor flyers, waterbirds, diving birds, marine soarers, aerial predators, and thermal soarers. Bevanger (1994, 1998), Janss (2000), Crowder and Rhodes (2002), and Rubolini et al. (2005) have also evaluated different species and their collision susceptibility using wing loading and wing aspect ratio. They found in general that birds

FIGURE 4.6: Wing loading and aspect ratio, among other factors, influence susceptibility to collisions (after Bevanger 1998).

with high wing loading are more susceptible to collisions than birds with low wing loading; and that birds with low aspect ratios are more susceptible than birds with high aspect ratios. Birds with high wing loading and low aspect ratios represent poor fliers. Bevanger (1998), supported by Janss (2000) and Rubolini et al. (2005), also found this to be true.

High wing loading birds are frequently reported as collision casualties, including large, heavy-bodied birds with large wing spans such as herons (Mead et al. 1979), cranes (Walkinshaw 1956; Tacha et al. 1979; Brown et al. 1987), swans (Banko 1956; Beer and Ogilvie 1972), pelicans (Willard et al. 1977), and condors (D. Pearson, pers. comm.). These and similar species generally lack the maneuverability to quickly avoid obstacles.

Heavy-bodied, fast fliers are also vulnerable to collision. This characteristic is typical of most waterfowl, coots, rails, grebes, pigeons and doves, and many shorebirds (e.g., sandpipers and plovers). For example, waterfowl accounted for the majority of collision mortality at a site in the San Luis Valley, Colorado (Brown and Drewein 1995). Researchers have also noted that species with long legs and necks collide more often than those with more compact profiles (NUS Corporation 1979, unpubl., cited in Hunting 2002).

In comparison, terns with low wing loading and smaller body size are considered agile fliers and have a keen ability to avoid lines despite their high potential exposure. Henderson et al. (1996) found only two casualties beneath wires in a study of a common tern (*Sterna hirundo*) colony located within an industrial complex, where birds of all age classes and both sexes were making hundreds of flybys per hour (>10,000 flybys observed).

Body size and maneuverability do not explain all collision risk. Other factors can also contribute. For example, gulls and terns have low wing loading, yet they can be subject to collisions because of behavioral



FIGURE 4.7: Birds with high wing loading, such as swans, are more susceptible to collisions.

© JERRY LIGUORI

characteristics, such as flocking, spending large amounts of time in the air, and flying at night. Although the low wing loading (light body) gives gulls and terns a more buoyant, graceful, and potentially slow flight speed, they are over-represented in Janss' mortality data set because of their large abundance at his study sites. This point is also made by Bevanger (1998) who cites observational studies by Meyer (1978), James and Haak (1980), and Beaulaurier (1981) to assert that gulls were 50 to 100 times less likely to collide with power lines when compared with ducks.

Passerines (songbirds) were reported in Bevanger (1998) to have a great deal of variation in flight morphology, yet most are not particularly heavy bodied or thin winged. Certain songbirds such as European starlings (*Sternus vulgaris*) may be so abundant that their representation among power line collision casualties may actually be attributed to abundance rather than susceptibility (Janss 2000). On the other hand, passerine carcasses are so small that they are much more difficult to discover and may be under-reported (Scott et al. 1972, cited in Drewitt and Langston 2008).

FLIGHT BEHAVIOR

Understanding the flight behavior of birds active near a power line can be useful in identifying the potential risk for collisions and how those risks might be reduced. The following flight behaviors have been reported in the literature (e.g., Drewitt and Langston 2008) as influencing collision risk:

- Flocking
- Flight altitude patterns of migrating and non-migrating birds
- Courtship, nest building, and feeding flights to and from and around the nest, especially for colonial species
- Flight ability of fledglings and juveniles
- Flights between nesting/roosting and foraging areas

Flocking species, such as waterfowl and wading birds, are more vulnerable to collisions than solitary species (Bevanger 1998; Crowder 2000; Crowder and Rhodes 2002;

Drewitt and Langston 2008). The density of large flocks leaves little room to maneuver around obstacles; in fact, birds sometimes collide with each other when panicked (Brown 1993). Bevanger (1998) and Drewitt and Langston (2008), citing several studies, conclude that flocking behavior may lead to greater susceptibility, as trailing birds have obstructed views of an upcoming obstacle. Crowder (2000) and Crowder and Rhodes (2002) observed that flocks react to power lines at a greater distance from the line than do solitary birds. Scott et al. (1972) and James and Haak (1980) stated that flocking behavior was an important factor in starling collisions, as did Blokpoel and Hatch (1976) for snow geese (*Chen caerulescens*). A number of birds within large flocks of sandhill cranes were involved in power line collisions in the Platte River area, Nebraska; in several instances collisions of some birds within flocks were observed (Murphy et al. 2009).

Flight altitude is a function of species and environmental conditions such as winds, thermal conditions, visibility, precipitation, and time of day, as well as the type of flight (Newton 2008). Two types of bird flight altitude are observed: migrating or non-migrating.

Migrating birds take advantage of thermals and stronger tail winds when conditions permit, allowing them to conserve energy (Newton 2008) while staying well above power lines. In general, flight altitudes of migrating birds range from a couple hundred meters (m) (several hundred feet [ft]) to more than 6,000 m (20,000 ft). Weather conditions (e.g., wind speed and direction) influence flight altitude of migrants (see *Weather Conditions and Visibility*, page 48). Most transmission towers in the United States range from 15.2 m (50 ft) to less than 60.9 m (200 ft)¹¹ high depending upon design and voltage. If a



FIGURE 4.8: Flocking species, such as these snow geese, can be more vulnerable to collisions.

© JERRY LIGUORI

¹¹ Some structures exceed 61 m (200 ft) in height especially at river crossings and to clear other lines that might otherwise intersect (M. Schriener, pers. comm.; D. Bouchard, pers. comm.).

bird's flight altitude is at or below the height of power lines, collision risk can increase.

There are two basic types of migrating birds: long distance and daily migrants. Long distance migrants can fly thousands of kilometers (miles) without stopping and will have the least exposure to power lines during migration (e.g., some shorebirds, swallows, swifts, and terns). Most long distance migrants migrate at night, resting and feeding during the day (Manville 2007a). Daily migrants take shorter flights and make numerous stops to rest and feed (Newton 2008). Daily migrants include cranes, ducks, geese, and raptors. If power lines are in their landing or take-off paths, collision risk increases.

For non-migrating birds, flight altitude is likely to be within the range of power line height. Their flight is a function of their feeding, reproductive, and foraging behaviors. These behaviors usually occur within approximately 200 m (660 ft) of the ground, which can expose birds to collision risk when in the proximity of power lines. For predatory birds, the exposure to collision risk can be related, in part, to the pursuit of prey. Bevanger (1994) suggests that aerial hunters such as swifts, swallows, and certain raptors, such as the peregrine falcon (*Falco peregrines*), golden eagle (*Aquila chrysaetos*), and goshawk (*Accipiter gentilis*), typically have excellent maneuverability and very good vision. Yet because they chase prey at high speeds, the presence of a power line may not be perceived soon enough to avoid a collision with it.

Flight related to nesting behavior can increase collision risk if nests occur in close proximity to power lines. Such behavior includes courtship (e.g., aerial displays and pursuit), nest building, fledgling flights, feeding flights to and from the nest, territorial defense, and general flying around the nest or colony. These behaviors are most important

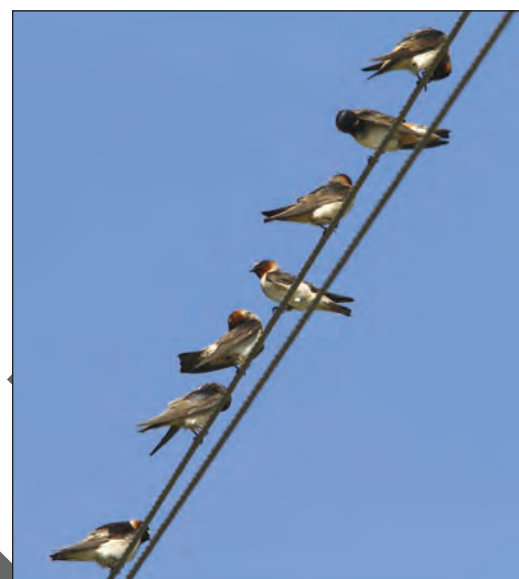


FIGURE 4.9: Aerial hunters that forage in flight within a couple hundred meters (several hundred feet) of the ground, such as swallows, can become collision victims.

© JERRY LIGUORI

for birds that nest in colonies, such as herons and egrets. Risks can also be associated with the age of a bird (i.e., adults and juveniles). Older birds are often acclimated to the presence of a line and will exhibit lower collision risk through well-developed flight patterns. Fledgling birds have less control of the flights and are more vulnerable to collisions than adults (see *Age and Sex*, page 41). There may also be risks for birds crossing a power line from the nesting site to a foraging area. Again, this is most important for colonial birds that will travel together to feed (see also *Habitat and Habitat Use*, page 44). Collision risks to foraging birds will occur when birds departing from and returning to a colony have to cross power lines. Their risk will be a function of the direction of foraging flights and the frequency of crossings. Mojica et al. (2009) reported 21 bald eagle (*Haliaeetus leucocephalus*) mortalities attributed to power line collisions in a study in Maryland conducted from 1985 to 2007.

VISION

Information on the visual acuity of birds relative to power lines is generally lacking (Bevanger 1998). However, when they are able to see power lines, birds do exhibit avoidance behavior. The use of line marking devices that increase the visibility of lines has confirmed this (see Chapter 6).

For birds, detecting power lines depends on the visibility of the wires and on the characteristics of their vision. Compared to humans, the frontal vision of many bird species is not high-resolution, and many species mainly use their lateral vision to detect details (Martin 2011). Birds often tend to look downwards when in flight (e.g., to look for conspecifics [their own kind] or food), which for some species puts the direction of flight completely inside their blind zone (Martin and Shaw 2010; Martin 2011; CMS 2011a).

Some birds have highly developed vision that they use to capture prey and avoid predators (Gill 1995). The eyes of most birds are on the sides of their heads, which allows them to see things on each side at the same

time as well as in front of them. This wide field of vision enables birds to spot predators and obstacles. However, widely spaced eyes can make judging distances and depth perception more difficult, except in the area where the eyes' fields-of-view overlap.

In addition, birds have blind spots caused by the length, width, and position of their bills. For some species, depending upon the size and movement of their bill, these blind spots can reduce the visual field. Researchers have noted that swans' poor frontal vision makes them more susceptible to collision (Martin and Shaw 2010). Martin and Shaw (2010) provided evidence that some species, such as bustards and cranes, have extensive blind spots in the frontal hemisphere and that downward head movement (forward pitch) greater than 25 degrees and 35 degrees, respectively, can render them blind in the direction of travel. If this occurs, objects directly ahead of the bird may not be detected during flight regardless of the visual capacities of the bird's eyes or the size and contrast of the object.

Raptors' eyes are closer to the front of their heads, giving them binocular vision, which is important for making distance judgments while pursuing prey. Having depth perception also makes them less vulnerable to collisions than birds with eyes on the sides of their head.

Birds with eyes adapted to underwater vision, such as ducks, tend to be emmetropic (objects are in sharp focus) in water and slightly myopic (nearsighted) in air (Jones et al. 2007). This may affect their ability to detect small diameter wires as they approach them at high speeds. A red-breasted merganser (*Mergus serrator*) was observed colliding with a shield wire with no reaction prior to the collision, and other mergansers were observed flying within 30.5 cm (12 in) of the shield wire with no reaction (N. Turley, pers. comm.). These observations suggest that the



FIGURE 4.10: Swans' poor frontal vision, along with their large size, increases their susceptibility to collisions.

mergansers were not aware of the wire, which indicates that vision characteristics may play a role in collision risk. Examples of other birds in this group with eyes adapted to underwater vision include loons, grebes, other diving ducks (buffleheads, scoters, and eiders), gannets, and kingfishers.

Some species have the ability to keep objects at different distances in focus simultaneously. For example, they are able to scan the horizon while keeping the ground in focus during flight, regardless of changes in elevation. This is believed to be achieved by asymmetry of the lens and cornea about an optical axis (Jones et al. 2007). This results in the eye being emmetropic in some parts of the visual field (the lateral and upper lateral visual fields) and myopic in others (lower lateral visual fields). For prey species such as pigeons, these characteristics allow the bird to scan the horizon for predators and conspecifics while foraging for objects on the ground. This same ability is also found in quail and sandhill cranes (Jones et al. 2007), but is generally not possessed by raptors or other species that must capture mobile prey.

In the last two decades, research on avian vision has indicated that ultraviolet sensitivity is an important component of avian vision. Birds detect a wider bandwidth of light in the violet and ultraviolet (UV) spectrum (440 nanometers [nm] to 10 nm) than humans do. This difference in sensitivity may relate to many different aspects of bird behavior including prey detection, foraging, display and mating, navigation, and circadian rhythm (Hart et al 1998; Bennett and Thery 2007). Based on this research, UV materials



FIGURE 4.11: Because they are nearsighted and fly at high speeds, mergansers may be unable to readily detect small diameter wires as they approach them.

© JERRY LIGUORI

have been applied to line marking devices to help birds detect hazards that otherwise would not be seen. However, these UV materials have not been systematically tested in collision studies.

Regardless of a bird's vision, environmental conditions such as inclement weather and the time of day (e.g., low light or dark) can reduce a bird's ability to see even marked power lines. A number of line modification and marking strategies can be used to reduce the effect of these factors (see [Chapter 5](#) and [Chapter 6](#)).

AGE AND SEX

Age and sex have a species-specific influence on collision risk. Crowder (2000) cites numerous studies showing that juveniles are more susceptible than adults (Thompson 1978; McNeil et al. 1985; Brown et al. 1987; Crivelli 1988; Savereno et al. 1996; Mathiasson 1999) but also notes two examples where adults are more susceptible (Ogilvie 1966; Anderson 1978). Brown et al. (1987) and Morkill and Anderson (1991) demonstrated statistically that juvenile sandhill cranes col-

lided with power lines more frequently than their proportion of the population would indicate. Conversely, Anderson (1978) found that adult mallards (*Anas platyrhynchos*) were more vulnerable to collisions than juveniles. Ogilvie (1966) suggested that age was not a factor in collision susceptibility for mute swans.

Many authors suggest that young birds or those unfamiliar with the area are more vulnerable than experienced birds (Anderson 1978; Thompson 1978; McNeil et al. 1985). The less-controlled flight of young birds also increases their collision risk. These birds are generally



FIGURE 4.12: Some juvenile birds, such as sandhill cranes, collide with power lines more frequently than their adult counterparts.

© USFWS



FIGURE 4.13: Endangered Newell's shearwater mortalities at a Kauai power line were mostly non-breeding adult and subadult birds.

© KEITH SWINDLE, USFWS

believed to be more susceptible to both electrocution and collision, though this may be confounded by the greater proportion of young birds in the population (Bevanger 1998). Most (11 of 14 = 78.6%) of Newell's shearwater collisions at a Kauai, Hawaii, power line were non-breeding birds, though many of those were likely subadults. The proportions of non-breeding adults and subadults in the population were not reported (Cooper and Day 1998). Juveniles of many migratory species are especially at risk because they have not yet encountered nor learned to avoid the assortment of risks they face.

Less information about the differing vulnerability of sexes exists because comparative data are rarely available. However, several studies have presented evidence that male ducks are more prone to collisions than females (Boyd 1961; Avery et al. 1977; Willard et al. 1977; Brown and Drewien 1995). The courtship and pursuit behaviors of male ducks greatly increase their frequency of local flights and can distract them from seeing and avoiding power lines. Distractions for other species also include pursuit of mates, competitors, or prey, which can increase collision risk (Willard et al. 1977; Anderson 1978).

HEALTH AND CONDITION OF THE BIRD

Studies of birds killed by power line collisions indicate that poor health may increase collision risk. Mute swans with elevated blood lead levels had higher collision risk than did healthier birds (Kelly and Kelly 2005). Low weight swans and swans with heavy burdens of toxins were over-represented among swans killed by collisions in Sweden (Mathiasson 1999).

The ability of the bird to maneuver can also be impaired by entanglement with fishing lines and other anthropogenic materials. Manville (2005b) reported on entanglement issues involving Canada geese (*Branta canadensis*) and other waterbird species with six-pack beverage rings and monofilament fishing line, along with plastic debris ingestion, all of which may increase their susceptibility to power line collisions due to weakened conditions, altered aero-dynamics, and impaired health.

Collision mortality can also lead to health effects in populations of birds. In rare instances, collisions that occur in high enough numbers can indirectly contribute to some diseases,

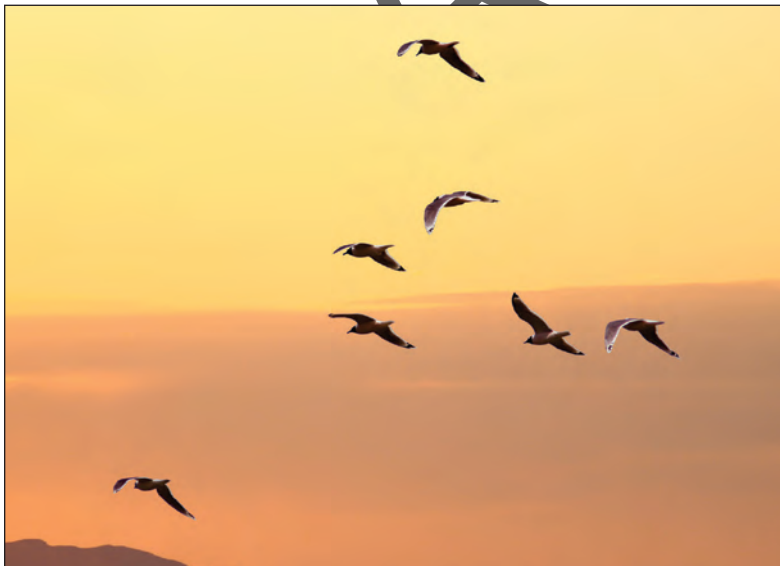
such as botulism. Malcom (1982) reported the deaths of several thousand grebes and ducks from botulism that were initiated by the victims of collisions with a transmission line in south central Montana. The collision victims fell into a wetland where their carcasses provided the energy substrate in which dormant *Clostridium botulinum* spores became active. These bacteria produce a toxin that invertebrates consume and concentrate without ill effects. Those toxin-laden invertebrates (e.g., fly-egg-maggot) become food for other ducks and a vicious cycle can develop and become protracted (Rocke and Friend 1999), much as Malcom observed.

TIME OF DAY AND SEASON

Time of Day

Studies have shown that time of day is important to collision frequency in daily flights and during migration. Different species generally feed at different times of day. Non-breeding birds, including migrating species, generally feed continuously during the day and are considered to have continuous exposure to power lines in the vicinity of their feeding areas. When birds are nesting, they often show a periodicity in feeding.

Collisions are much more likely during the night than the day (Scott et al. 1972; Krapu 1974; Anderson 1978; and James and Haak 1980; all cited in Crowder 2000; Pandey et al. 2008). Gulls and waterfowl tend to make feeding flights after sunset and before sunrise. Many waterbird species regularly fly at night in response to tidal cycles or prey activity (Black and Collopy 1982; Erwin 1977; Robert et al. 1989; Dodd and Colwell 1998) or predator avoidance. Inability to see the wires due to low light conditions probably raises the collision risk for these species (Scott et al. 1972; Krapu 1974; James and Haak 1980; Brown and Drewien 1995). At the San Luis National Wildlife Refuge Complex in California, bird flight diverters were effective on waterfowl but not on coots, which authors attribute to the fact that coots



© JERRY LIGUORI

FIGURE 4.14: Gulls (pictured) and waterfowl tend to make feeding flights at dusk and dawn, when reduced light increases collision risk.

fly at night and cannot see the diverters (Ventana Wildlife Society 2009).

Species that migrate at night, such as songbirds and herons, may be vulnerable to collisions if weather forces them to fly at low altitudes. However, generalizing from one species to another or one habitat to another that nocturnal flight behavior may be more risky than diurnal flight behavior needs to be cautioned. Deng and Frederick (2001) investigated nocturnal bird flights of wading birds in the vicinity of a 550-kV transmission line adjacent to the Everglades in south Florida. They observed nine species of wading birds including herons, egrets, and wood storks (*Mycteria americana*). The investigation showed that nocturnal-flying wading birds were less responsive to the power lines than diurnal-flying birds; however, the birds generally flew higher over the power lines at night than during the day. No collisions were observed but the authors stated that the sampling period was short (118 hours). One of the suggested reasons for the lack of collisions was that the birds were acclimated to the presence of the line.

Similarly, radar data collected by Harmata et al. (1997) along the Missouri River indicated that birds flying at night flew at heights well above power lines. By flying higher at night, waterbirds and other species may lower collision risk with natural and anthropogenic obstacles. However, there may be risks from lines that occur in the departing and arriving zones for roosting or foraging habitats. For example, dark-rumped petrels (*Pterodroma phaeopygia*) and Newell's shearwaters in Kauai, Hawaii, crossed much closer to power lines in morning seaward flights than in evening landward flights, and all recorded Newell's shearwater collisions occurred during morning flights (Cooper and Day 1998).

Season

Seasonal bird abundance is also correlated with collision mortality. For example, seasonal flight behavior differences resulted in more

wintertime collisions for ptarmigan in Norway (Bevanger and Broseth 2004). Migration seasons generally pose a greater risk to migrating birds because of both higher fly-over frequency and unfamiliarity with local landscapes. The nighttime proportion of crane and waterfowl collision mortality versus total collision mortality was 31.8% in the fall (1990) during migration and 7.7% in the spring (1991) in San Luis Valley, Colorado (Brown and Drewein 1995).

Willard (1978) described a situation in the Klamath Basin, Oregon, that illustrates how both collision mortality and its population effects can increase during the breeding season. At Lower Klamath Lake National Wildlife Refuge, adult American white pelicans (*Pelecanus erythrorhynchos*) flew low over canals and collided with power lines while searching for food. For this species, this meant a double loss: first, the loss of the adult that collided with the line, and second, the loss of the young, which rarely fledge after one parent is lost because both parents must forage extensively to feed them.

HABITAT AND HABITAT USE

Power lines located near habitats with high avian use (such as nesting, foraging, roosting, and resting sites) may pose greater exposure to collisions for some species. For example, power lines between foraging and roosting sites of wading birds will be frequently crossed, which increases the collision risk potential. This is especially true when only a short distance separates the two habitats. Birds in these situations typically fly at low altitudes, potentially putting them at the height of power lines. Willard et al. (1977) suggested that overhead wires within a single habitat (e.g., within a wetland) are more likely to cause collisions than those between two habitats (e.g., wetlands and uplands); other studies have found the opposite to be true (e.g., Faanes 1987; Brown et al. 1987; Morkill and Anderson 1991).

The critical questions are how often, and in what numbers, do birds fly across a power line during their daily routines? For example, in a study in the San Luis Valley of Colorado, Brown et al. (1987) found that power lines dividing wetlands (used for roosting) from grain fields (used for feeding) caused the most collisions for sandhill cranes and field-feeding waterfowl. This occurred because these habitats encouraged the birds to cross the lines at low altitudes several times each day. However, the same power lines had little effect on diving ducks, which had restricted their activities to wetlands. Thus, the risk of a particular power line depends in part upon the way each species uses the adjacent habitat.



FIGURE 4.15: Power lines located between the foraging and roosting sites of wading birds, such as this white ibis (*Eudocimus albus*), may result in higher collision risk.

© JERRY LIGUORI



FIGURE 4.16: Research conflicts on whether or not overhead wires within a single habitat, such as this wetland, are more likely to cause collisions than those between two habitats.

© NIKKI HECK

Power lines, including those that border habitat such as a wetland used by many birds, may present little risk if the adjacent habitat separated by the power lines is not attractive to birds (e.g., a city rail yard). Conversely, if the adjacent habitat is a grain field, collisions may result in fall and winter for field-feeding birds that make daily flights between wetland roosts and foraging sites, including sandhill cranes, Canada geese, mallards, and pintails (*Anas acuta*) (Thompson 1978; Brown et al. 1987; Morkill and Anderson 1991). The same line may represent lower risk during the breeding season when these birds remain in wetlands throughout the day. Although forested habitats located near power lines can

sometimes reduce collision risk (see *Managing Surrounding Lands* on page 58), in some forested habitats where there are open clearings for the power lines, collision risk may be higher for birds that fly across the open corridor while going between forested areas.

During migration, birds make stopovers in their preferred habitats. When migratory birds' staging, roosting, resting, and foraging areas are located near power lines, especially when ingress or egress coincides with inclement weather, collision risk increases (Manville 2005a, 2009a). This can be especially true when there are large concentrations of birds; for example, sandhill cranes that number in the tens of thousands along the Platte River in Nebraska (Murphy et al. 2009).

Some habitats, such as lakes and ponds, have seasonal use patterns. Proximity to shoreline habitat was linked to bald eagle collisions (21) and electrocutions (24) at Aberdeen Proving

Grounds, Maryland (Mojica et al. 2009). Higher collision mortality was found at power lines near shorelines used as feeding areas. The 16,000 hectare (39,537 acre) area on Chesapeake Bay had 42 resident pairs and seven known communal roosts used by migrants from the north and south during the winter and summer months, respectively. In a high bird concentration area along Lake Ontario, double-crested cormorants (*Phalacrocorax auritus*) were the most commonly reported collision victim, although they were over-represented relative to their abundance in the area, and gulls and waterfowl were the next most commonly reported species to collide with lines (Barrett and Weseloh 2008). A PacifiCorp study calculated the distance of collision mortalities to the nearest water body using survey data collected in Oregon, California, Idaho, Utah, and Wyoming from 2004 to 2009 (S. Liguori, PacifiCorp, unpubl. data) (Table 4.2).

TABLE 4.2: Average distance of collision mortalities from nearest water body.*

Species	Sample Size	Average Distance
Show goose (<i>Chen caerulescens</i>)	37	82.3 m (270 ft)
American white pelican (<i>Pelecanus erythrorhynchos</i>)	17	82.6 m (271 ft)
Tundra swan (<i>Cygnus columbianus</i>)	3	89.3 m (293 ft)
Sandhill crane (<i>Grus canadensis</i>)	7	119.8 (393 ft)
Great blue heron (<i>Ardea herodias</i>)	7	154 m (505 ft)
Mallard (<i>Anas platyrhynchos</i>)	5	213.4 m (700 ft)

* Source: PacifiCorp, unpubl. data

ENVIRONMENTAL CONDITIONS INFLUENCING AVIAN COLLISION RISKS

Environmental conditions that can increase the risk for collisions with power lines include:

- Land uses
- Weather conditions and visibility
- Sudden disturbances

The relative importance of these conditions varies with location, season, species, and different populations of the same species.

LAND USES

Land uses, such as conservation, recreational, residential, agricultural, and industrial, have

habitats and management practices that can attract or discourage bird use. Collision risk depends on the location of power lines within these areas and the bird species that are drawn to them.

Conservation and Nature-Based Recreation Lands

Conservation areas and wildlife refuges vary greatly in size and habitat type and are often managed for specific types of wildlife and/or nature-based recreation uses. Many conservation lands have distribution lines that supply their power needs and may also be crossed by transmission lines. These lines may present collision risk depending on the habitats, species, and human activities present. The potential for disturbing and flushing birds into nearby power lines can be higher in recreation areas due to increased human activity or lower if resident birds are acclimated to human activity. Power lines that cross high avian-use habitats such as wetlands or are placed between foraging and roosting areas may also result in a higher risk of bird collisions (see *Habitat*

and *Habitat Use* on page 44). Although a proposed power line route may not be able to avoid such conservation areas, managers need to be aware of the potential risks so they may be minimized (see *Chapter 5*).

Residential and Urban Recreation Lands

Residential and urban recreation lands vary widely in their attractiveness to birds (e.g., Chace and Walsh 2006). Generally, urban recreation lands such as parks and golf courses are interspersed within or between densely populated residential areas. These lands often become habitat islands. For example, they may have small wetlands that are used by various protected birds. Distribution lines may be especially plentiful in residential and recreational areas and can pose a collision risk, depending on the susceptibility of the species, when situated in the flight patterns of birds.

Agricultural Lands

Agricultural fields and ponds can attract birds; for example, grain crops are seasonally attractive to many flocking species such as cranes, waterfowl, and blackbirds, along with rodents that attract raptors. Because grain fields are used only as feeding areas by these species, they may be attractive when they are in close proximity to nesting, roosting, or wintering habitat. Agricultural fields, especially those that are managed with burning or flooding or have nearby wetlands, can also attract a variety of bird species during staging and migration and may even result in shortstopping, i.e., drawing birds to these attractive sites for the winter rather than their historical wintering sites (Viverette et al. 1996). Collision problems may develop when birds must cross power lines to make daily, low-altitude flights between feeding areas and nesting or roosting sites. See also *Habitat and Habitat Use* (page 44).

Industrial Lands

Industrial lands sometimes provide attractive bird habitat. Gulls, vultures, crows, ravens, and



FIGURE 4.17: Power lines crossing agricultural fields with seasonally attractive crops or residue can contribute to collision risk for some flocking species, such as cranes, waterfowl, songbirds, and these trumpeter swans (*Cygnus buccinator*).

other scavengers often gather at landfills in large numbers. Cooling ponds at electricity generation facilities, municipal sewage ponds, settling ponds at mines, and other industrial water bodies can attract waterbirds, shorebirds, and raptors. As with other types of land use, the degree of hazard posed by power lines will vary depending upon the proximity of the lines to these avian-use areas (see *Habitat and Habitat Use* on page 44). If bird collisions become a problem, property managers may be able to choose from a variety of options to modify or discourage bird use of the area (see *Managing Surrounding Lands* on page 58).

WEATHER CONDITIONS AND VISIBILITY

Weather conditions play a very important role in both the visibility of power lines and in the behavior of birds in flight during migration and local movements, such as daily foraging activity. When weather conditions interact with biological characteristics (e.g., flight behavior, wing loading and aspect ratio, and season), collision risk may be dramatically affected.

Adverse weather conditions, such as fog, dense cloud cover, high and variable wind speeds, precipitation, and reduced or zero visibility are associated with greater collision risk. Reduced visibility and high wind speeds can also cause birds to fly at lower altitudes, potentially putting them at the same height as power lines. The influence of weather on flight altitude was reviewed in depth by Shamoun-Baranes et al. (2006), and the effect of weather on flight height and behavior has been observed in many bird species (Drewitt and Langston 2008; Newton 2008).

Weather and biological factors are often interrelated and may affect flights within high bird-use areas. The timing of daily flights may subject certain species to adverse weather conditions associated with collisions, such as fog (Scott et al. 1972; Tacha et al. 1979) or wind (Brown 1993). This is especially true in coastal and low-lying areas that are frequently foggy or windy. When possible, birds will avoid fly-

ing in heavy precipitation or fog. Problems most often occur when birds unexpectedly encounter these conditions. Storms or fog can arise quickly and birds may collide with power lines when attempting to leave feeding areas for protected roosts (Wheeler 1966; Tacha et al. 1979). In foul weather, birds may be attracted to lighted areas on the ground (Manville 2007a). If power lines are also in or near those areas they could be in the landing approach of the attracted birds and become a collision risk (see *Lighting*, page 52).

Wind, wind shear, and turbulence most often appear to influence collisions when birds fly at power line heights. Some birds decrease flight altitude in high winds (Scott et al. 1972; Raavel and Tombal 1991). Poor conditions—wet feathers, precipitation, high winds, wind gusts, and turbulence—also hamper birds' ability to control flight and further increase collision risk (Walkinshaw 1956; Avery et al. 1977; Willard et al. 1977; Anderson 1978). In high-velocity winds, birds may collide with other birds, buffeting them into fully visible and familiar power lines (Brown et al. 1987; Morkill and Anderson 1991; Raavel and Tombal 1991; Brown and Drewien 1995).

In the San Luis Valley, Colorado, collisions occurred more frequently on days with winds >24 km per hour (15 mi per hour) (Brown and Drewien 1995). Collisions were also more likely with tailwinds, which increase a bird's ground speed, than with headwinds, which have the opposite effect (Savereno et al. 1996). Crowder (2000) reviewed older evidence of power line collisions resulting from stormy (Wheeler 1966), foggy (Tacha et al. 1979), or windy (Brown et al. 1987; Morkill and Anderson 1991) conditions. These studies showed that wind, especially associated with stormy weather, is an important contributor to collisions. It has been suggested that birds, such as gulls, with a high aspect ratio and low wing loading are more susceptible to being blown into lines than other bird



© JERRY LIGUORI

FIGURE 4.18: Birds usually initiate migration in favorable weather conditions, but when they encounter inclement weather they may decrease their flight altitude, which increases collision risk when power lines are present.

species without these physical characteristics (Bevanger 1998).

The impact of weather is also related to season, as adverse weather may pose a greater risk during migration (APLIC 2007) and can influence the initiation of migration (Shamoun-Baranes et al. 2010). Songbirds usually begin migration in favorable conditions, but may encounter inclement weather en route. The weather hazard may be worsened when migratory birds respond to fog and precipitation by decreasing their flight altitude (Gauthreaux 1978a) or by attempting to land (Manville 2007a). In known or historic staging, roosting, resting, feeding, or stopover areas for migratory birds located in immediate proximity to power lines, there can be a substantial increase in collision risk, especially when bird ingress or egress coincides with inclement weather (Manville 2005a, 2009a). This effect is magnified when flocks are very large, as with migrating sandhill cranes in the Platte River area of Nebraska (Murphy et al. 2009).

The flight altitudes of migratory birds can vary greatly and are strongly correlated with winds aloft, air clarity, turbulence, thermals, and weather, both day and night. In particular, thunderstorms and low cloud ceiling conditions are known to cause nocturnally migrating songbirds to land or to fly at lower altitudes that increase collision risk, particularly with illuminated structures (Winkelman 1995; Gill et al. 1996; Erickson et al. 2001; Johnson et al. 2002; Kerlinger 2003). Various radar studies have estimated that under normal weather conditions, 84% to 97% of nocturnally migrating songbirds fly at altitudes of 125 m (410 ft) or more above ground level where they are not exposed to risk of collision with power lines (Mabee and Cooper 2002; Cooper 2004; Mabee 2004).

SUDDEN DISTURBANCES

Sudden disturbance can panic and flush birds, especially flocks of birds, into nearby power lines and has been well documented as a contributing factor to collisions (Krapu 1974; Blokpoel and Hatch 1976; Anderson 1978; Brown et al. 1984; Archibald 1987). Birds may be flushed by vehicles, trains, pedestrians, aircraft, farm equipment, hazing, hunters, predators, etc., along ROWs and may collide with power lines in their effort to escape (APLIC 2007). Crowder (2000) reviewed older evidence of power line collisions resulting from sudden disturbance of geese by vehicles (Schroeder 1977) or airplanes (Blokpoel and Hatch 1976). One such disturbance resulted in a collision event with mallards during Crowder's (2000) field study. Murphy et al. (2009) support the idea that most sandhill crane collisions at Platte River, Nebraska, occur when closely congregated birds are flushed after dark. In Washington, roosting American white pelicans collided with an adjacent distribution line when flushed during the night by a passing train, even though line marking devices were installed (S. Liguori, PacifiCorp, pers. comm.).

ENGINEERING ASPECTS INFLUENCING AVIAN COLLISION RISKS

The following engineering aspects can influence the risk of collisions with power lines:

- Diameter of lines (shield wires versus phase conductors)
- Line placement (proximity to avian habitat)
- Line orientation (relative to biological and environmental factors)
- Line configuration (aligned vertically or horizontally and the number of lines)
- Structure type (guyed versus self-supporting)
- Lighting (steady burning versus blinking)

DIAMETER OF LINES

The smaller diameter of transmission line shield wires compared to phase conductors influences the risk of collisions, with shield wires being the lines most often involved (Scott et al. 1972; Willard et al. 1977; Brown et al. 1987; Faanes 1987; APLIC 1994; Savereno et al. 1996; Jenkins et al. 2010). Because of their smaller diameter (1 to 1.3 centimeters [0.4 to 0.5 inches]) compared to phase conductors (2.5 to 5 cm [1 to 2 in]) and their position above the phase conductors, shield wires are the least visible type of power lines and they are in the flight path of birds that gain altitude to avoid the more obvious phase conductors. The shield wire protects, or shields, the phase conductors from lightning strikes.

Distribution lines consist of phase conductors and a neutral wire, which is at the same level or below the phase conductors. Though it is not absolute, most birds gain altitude to avoid an obvious line, which implies that neutral lines are less likely to be involved in collisions.

LINE PLACEMENT

The proximity of power lines to bird take-off and landing areas can affect collision risk (Lee 1978; Thompson 1978; Faanes 1987), but no specific setback distance has been found in the literature. Brown et al. (1984, 1987)

found that no sandhill crane or waterfowl collisions occurred where distances from power lines to bird-use areas were ≥ 1.6 km (1 mi). Faanes (1987) found that collision rates dropped off dramatically after 400 m (1,312 ft). Faanes (1987) stated that “among the sites I examined, power lines situated 400 m (1,312 ft) or more from the edge of the water generally had lower observed mortality than sites where the power line was within this distance.” Quinn et al. (2011) found no bird carcasses under power lines that were situated more than 500 m (1,640 ft) from the edge of the water; at distances of 60 m (197 ft), collision mortality dropped off dramatically ($p = 0.0012$, $df = 3$). See also *Habitat and Habitat Use* on page 44. See [Chapter 5](#) for examples of risk and reduced risk situations.

LINE ORIENTATION

Orientation of power lines relative to biological characteristics (e.g., flight behavior, season, habitat, and habitat use) and environmental conditions (e.g., topographical features and weather patterns) can influence collision risk. When planning power line routes, features that are traditional flight corridors, such as mountain ridges, river valleys, and shorelines, should be considered (Colson and Yeoman 1978; Faanes 1987). Power lines that parallel primary bird flight paths pose less risk than a perpendicular orientation (Crowder 2000; Scott et al. 1972; McNeil et al. 1985). For example, the perpendicular orientation of a line relative to a topographical feature poses a greater collision risk to local and migrating birds than a parallel orientation (see [Figure 4.19](#)).

Lines that are at or below the height of nearby trees rarely present a problem to small tree-dwelling birds because of their maneuverability; furthermore, large birds will gain altitude to fly over the tree line and consequently avoid the power line (Thompson 1978; Ravel and Tombal 1991). For example,



© JERRY LIGUORI

FIGURE 4.19: Orientation of power lines parallel to ridges or narrow, low altitude flyways presents a lower risk of collision than perpendicular orientation.

a power line that crosses a narrow river bordered by trees that are taller than the line is likely to have a lower collision risk than lines crossing broad rivers because most birds will fly over the tree tops to cross the narrow river valley (CMS 2011a).

Strong tail winds can be detrimental to birds' ability to execute avoidance maneuvers. Brown (1993) suggested that north-south orientation of lines increased collision frequency for cranes and waterfowl in the San Luis Valley, Colorado, because birds crossing them on an easterly heading were often subjected to prevailing westerly winds. See also *Biological Characteristics*, on page 36, and *Weather Conditions and Visibility* on page 48.

LINE CONFIGURATION

Line configuration—phase conductors aligned vertically or horizontally, and the number of conductors—is a collision factor that intuitively makes sense, but there are too few studies to draw conclusions. Most researchers agree that keeping the vertical arrangement of multi-conductor transmission lines to a minimum is beneficial because it reduces the

height of the collision zone. However, a single-pole vertical structure is often esthetically more acceptable and requires less ROW width.

Thompson (1978) and others (Bevanger 1998; Crowder 2000; Drewitt and Langston 2008) have suggested that clustering lines (i.e., several power lines sharing the same ROW) may reduce the risk of collisions because the resulting network of wires is confined to a smaller area and is more visible. Birds only have to make a single ascent to cross lines before resuming their preferred altitude. However, when there is decreased visibility, collision risk for birds may increase where several lines are clustered together. In addition, when there are two shield wires at different heights, and only the higher one is marked, there may be collisions at the lower unmarked shield wire, thus both shield wires may need to be marked (S. Liguori, pers. comm.). See [Chapter 5](#) for examples of risk and reduced risk situations.

STRUCTURE TYPE

Because of the collision risk posed by guyed communication towers (e.g., Shire et al. 2000; Manville 2007a; Gehring et al. 2009; Gehring et al. 2011; Longcore et al. 2012), the question of collision risk associated with guyed power line structures has occasionally been asked. Guy wires on power line structures are used for support and stability especially where a line ends (deadend structure) or changes direction (e.g., makes a 90-degree turn). There is no published information to suggest that guyed power line structures pose a significant collision risk for birds. Pacific Corp has surveyed over 120,000 poles in six states and has not found collision victims at any of the guyed structures (S. Liguori, pers. comm.). Based on exposure alone, the relative short lengths of the guy wires and the low heights on power lines pose much less risk to birds than do the longer, multiple guy wires on communication towers whose height can

exceed 300 m (>1,000 ft; Gehring et al. 2011). In addition, some types of lighting on communication towers can attract birds into the collision zone in low visibility weather. Because transmission towers are, with very few exceptions, unlit, they are not expected to have the same risk.

LIGHTING

Studies of bird collisions with communication towers and other tall structures have shown that steady-burning white or red lights can disorient migrating birds at night especially when migration coincides with inclement weather (Manville 2007a, 2009; Gehring et al. 2009, 2011). This disorientation can cause birds to collide with the lighted structure, guy wires on a communication tower, or each other. It can also cause the birds to circle the light source, which may also result in exhaustion and injury or death. Collision incidence on lighted communication towers, for example, depends on the type and intensity of the lights (i.e., steady burning, blinking, or strobe) as well as whether the birds are navigating visually or magnetically. In a Michigan communication tower study, extinguishing steady-burning, L-810, red side

lights, while leaving on the red, blinking incandescent pilot warning lights, reduced bird collision mortality by up to 72% (Manville 2007a; Gehring et al. 2009). However, any light, including blinking incandescent and strobe lights, can cause some bird attraction, even during clear weather (Manville 2009a).

In the United States, any structure that is ≥ 60.9 m (200 ft) above ground level is subject to Federal Aviation Administration (FAA) lighting requirements for aviation safety. Transmission towers in the United States are typically < 60.9 m (200 ft) tall¹² and do not have lights. However, shorter structures may also require lighting depending on their location (e.g., in proximity to airports). If lighting is used on transmission lines, it should be compatible with FAA regulations, the Canadian Aviation Regulation, and USFWS bird protection guidelines, and these agencies should be consulted on lighting. The FAA no longer recommends using L-810 steady-burning red lights.¹³ In general, the USFWS recommends avoiding lights, particularly steady-burning lights, and using motion- and heat-sensitive lighting where feasible (e.g., for infrastructure security lighting).

¹² Some structures exceed 60.1 m (200 ft) in height, especially at river crossings and to clear other lines that might otherwise intersect (M. Schriener, pers. comm.; D. Bouchard, pers. comm.).

¹³ This change is expected to be included in the revision to the FAA's 2007 lighting circular, which is underway at this time (2012). As a preliminary step, in June 2012 the FAA published the results of its pilot conspicuity studies on the elimination of steady-burning red (L-810) side lights at communication towers.



CHAPTER 5

Minimizing Collision Risks

IN THIS CHAPTER

- Opportunities for Minimizing Collision Risks
- Modifying Existing Power Lines
- Planning New Power Lines
- Public Participation to Address Social and Cultural Issues

There are a number of design and engineering strategies for minimizing collision risk with power lines. This chapter introduces evaluation studies and risk reduction strategies for modifying existing lines and planning new lines. This chapter also discusses how to address social and cultural issues through public participation programs.

OPPORTUNITIES FOR MINIMIZING COLLISION RISKS

By working together, engineers and biologists can identify and address collision issues when modifying existing lines and planning new lines (Figure 5.1). Collision issues typically develop or are discovered long after a power line is built, which makes

minimizing collision risk more difficult. However, early evaluation of factors that influence collisions (see Chapter 4) can reduce collision potential and may reduce the need for costly modifications later.

Engineers and biologists can reduce collisions when...

Modifying Existing Power Lines	Planning New Power Lines
<p><i>Evaluation studies include:</i></p> <ul style="list-style-type: none"> • Collision monitoring to examine the causes and conditions associated with the risk and to help determine the type and effectiveness of modifications. • Avian risk assessment and spatial analysis to prioritize line segments for modification. 	<p><i>Evaluation studies include:</i></p> <ul style="list-style-type: none"> • Spatial analysis that considers habitat variables, species, behavior, and other factors to help choose the optimal route. • Field assessment to identify species, abundance, and high bird-use areas. • Avian risk assessment to evaluate collision risk along potential routes.
<p><i>Risk reduction options include:</i></p> <ul style="list-style-type: none"> • Line marking to increase the visibility of the line. • Managing surrounding land to influence bird use. • Removing the shield wire if lightning is not an issue or if lightning arresters can be used instead. • Increasing the diameter or changing the configuration of wires when a line is being rebuilt. • Rerouting the line if all other attempts have been exhausted and populations are significantly impacted. • Burying the lines if feasible and warranted. 	<p><i>Risk reduction options include:</i></p> <ul style="list-style-type: none"> • Line placement that takes migratory patterns and high bird-use areas into account. • Line orientation that considers biological and environmental factors such as bird flight paths, prevailing winds, and topographical features. • Line configuration that reduces vertical spread of lines, clusters multiple lines in the same right-of-way (ROW), increases the visibility of lines, and/or decreases the span length if such options are feasible. • Line marking to increase the visibility of the line. • Burying lines if feasible and warranted.

FIGURE 5.1: Opportunities and strategies for minimizing collision risks.

MODIFYING EXISTING POWER LINES

EVALUATION STUDIES FOR LINE MODIFICATIONS

If a significant collision risk has been observed along a segment of line, it may be possible to eliminate or minimize the risk by modifying the line in various ways. Line modifications should be supported by collision monitoring studies that examine the causes and conditions associated with a high collision rate (e.g., bird species involved, avian

use patterns, mortality rates, weather, and biological significance of mortality levels). Although collision monitoring study methods must be tailored to site-specific biological, environmental, and engineering factors (see [Chapter 4](#)), basic, standardized ornithological field survey procedures should be used to produce results that would be comparable to other studies. [Appendix B](#) presents considerations and issues for designing site-specific

Comparing the Effectiveness of Line Modifications

Assessments of line modification effectiveness are often based on pre- and post-modification mortality (Rigby 1978; Beaulaurier 1981; Archibald 1987; Brown et al. 1987). Although evaluations based on casual observations or limited sampling of collisions contribute to the knowledge of line modification effectiveness, more rigorous studies are necessary to adequately compare the effectiveness of various measures (e.g., Crowder 2000; Yee 2007, 2008; Ventana Wildlife Society 2009; and Pandey et al. 2008).

study methods for collision monitoring. Once monitoring data are collected, line modification options can be evaluated to identify, quantify, and balance existing risks with the effectiveness and risks posed by the modifications.

Collision Monitoring Studies

To design a collision monitoring study, a number of key questions need to be answered:

- What species is/are at risk?
- What is the magnitude of risk?
- Does this risk contribute to population level impacts?
- What biological, environmental, and engineering factors contribute to collision risk?
- Is the study protocol scientifically sound?
- What are the regulatory and policy considerations of collisions?
- What methods effectively minimize collisions for new and existing power lines?

Collision monitoring results should include the following information:

- Collision rates among species and between sexes and ages (if known) within a single species
- Collision rates expressed as the number of bird collisions relative to the number

- of birds that are exposed to the line in the strike zone, i.e., collisions/flybys
- Biological, environmental, and engineering factors affecting collision risks (see [Chapter 4](#))
- Mortality corrected for site-specific sampling bias (see [Appendix B](#))
- Behavioral responses of different species to the lines and to line marking devices or other modifications
- Effectiveness of line marking devices based on changes in mortality after marking devices were installed or other line modifications were made

These and other monitoring considerations are discussed in greater detail in [Appendix B](#).

To understand the mortality risk for an entire line, it is essential to study representative segments of the line rather than focusing only on high collision segments, since doing so will overestimate the overall mortality risk. The study method should ensure that test and control segments are of comparable length and that they have as much environmental homogeneity as possible (see [Appendix B](#)). On lines with high environmental variability across their length, stratified random sampling may allow the investigator to treat the segments similarly enough to collect meaningful data.

The greatest problem faced by researchers in most field studies is controlling for external variables (e.g., Alonso and Alonso 1999; Jenkins et al. 2010; Barrientos et al. 2011). The results of Brown and Drewien (1995) support the hypothesis of Thompson (1978) that collision rates are not predictable from one study to another and one season to another. They found that rates varied among species, seasons, and years and attributed much of the variability to changes in the local environment, which, in turn, influenced bird densities (see also Blair 1996). This suggests that, ideally, studies should compare test

and control line segments within the same time period.

Regardless of whether assessments are made before or after line modification or by using test and control segments, collision risk comparisons are most meaningful if collisions are expressed in relation to bird numbers or, preferably, flybys. This allows a collision rate to be calculated. Where feasible, observations of birds' avoidance behavior when crossing the lines are valuable in understanding how a line affects flight behavior. Actual mortality may be low, which presents a statistical challenge in comparing retrofitting options. This condition should be anticipated and integrated into the study design (see [Appendix B](#)).

Collision monitoring studies should incorporate the basic methods used in other mortality evaluations (see [Appendix B](#)) including:

- Defining the collision zone for birds crossing lines
- Establishing an adequate search area for mortalities (increasing with the height of the line)
- Obtaining sampling bias estimates for injuries, searcher efficiency, scavenger removal, and habitat differences

Evaluation of bird behavior at marked and unmarked lines provides insight to collision rates. Morkill and Anderson (1991) and Brown and Drewien (1995) demonstrated that bird responses varied with marked and unmarked lines. Observations should be made on marked and unmarked portions simultaneously to minimize environmental variability. For example, Deng and Frederick (2001) showed that the number of birds flying above or below marked and unmarked lines was not statistically significant; however, they observed that the birds approaching a marked line reacted earlier than birds approaching an unmarked line.

Behavioral criteria evaluated may include:

- Type of reaction to lines
- Distance from the line that the reaction occurred
- Height above the line when crossing

Because these estimates require evaluations by observers, it is important to standardize survey procedures (see [Appendix B](#)). All observers should be given training and practice time before the study begins and, when possible, the same observers should be used throughout the study. Brown and Drewien (1995) found that most observers required about 12 hours of practice before they became consistent. As an alternative to field observers, the Bird Strike Indicator (BSI), a vibration sensing and recording tool, can be installed on lines to detect bird strikes (see box, [page 57](#)). However, the BSI does not identify what species struck the line; hence, mortality monitoring or field observations, which would also reveal pre-strike behavior, would be required.

Avian Risk Assessment and Spatial Analysis

Avian risk assessment and spatial analysis can be used to prioritize segments of line for modification. See [Evaluation Studies for Siting New Power Lines](#) on page 64.

OPTIONS FOR MODIFYING EXISTING LINES

Potential options for line modification include line marking, managing surrounding land, removing the shield wire, changing the diameter or configuration of wires, and rerouting or burying existing lines where feasible. Utilities are encouraged to work with wildlife agencies (see [Chapter 3](#)) to evaluate collision risks to species of concern and options for reducing those risks. Typically, the first option is marking high risk segments of the line and/or managing the surrounding lands. Redesigning, reframing, relocating, or

Remote Sensing with the Bird Strike Indicator

The Bird Strike Indicator (BSI) is an automated vibration sensing and recording tool designed by Electric Power Research Institute (EPRI) to detect bird strikes on overhead lines. Previously, the only means for identifying whether collisions were occurring was for observers to monitor lines and to conduct ground surveys for bird carcasses. Manually monitoring bird collisions is labor-intensive, expensive, and its effectiveness is limited to daylight hours. Carcass surveys may correct for lack of monitoring during low-light periods, but these are often associated with vegetation, water, and scavenger detection biases (see [Appendix B](#)). Some birds also may fly beyond the search zone after the collision. If the collision itself was not observed then this type of contact would be missed by standard monitoring methods.



FIGURE 5.2: The Bird Strike Indicator, a tool used to detect bird strikes with power lines, can be installed from a bucket truck or helicopter.

BSI sensors can be installed on phase conductors or shield wires. Each installation will be unique to the surrounding environment. For example, the lightweight accelerometers in BSIs are meant to detect stress waves caused by avian collisions, but in one study, BSIs also picked up the vibrations from daily trains (M. Schriener, pers. comm.). For a horizontal line configuration, the BSI is only needed on the outside wires (M. Schriener, pers. comm.). The BSI generates a collision log including the wire struck along with the date, time, and temperature. The BSI wirelessly transmits these data to a base station in real time. Base stations serve multiple sensors simultaneously and are accessible through an interface. Each sensor is designed for up to six months of autonomous operation between battery replacements. The units check and report their health each morning and can be reprogrammed remotely.

Research during the development of the BSI (Pandey et al. 2008) and independent trials conducted afterwards (Murphy et al. 2009) demonstrated that the BSI is as reliable as human observers for detecting collisions during daylight. The technology is especially useful for monitoring collisions in low-light or no-light conditions and over-water crossings where carcass recovery is compromised. However, unlike human observations, BSI does not identify the species that struck the line; mortality monitoring or field observations would be required to determine this. The BSI has also been successfully used to monitor communication tower guy wire collisions in Cold Bay, Alaska, which demonstrated that the BSI allows continuous line monitoring under all lighting and weather conditions (R. Harness, pers. comm.).

As of 2012, a new companion technology to the BSI, called the Bird Activity Monitoring System (BAMS), is in its technical development phase with EPRI funding and is envisioned as an intelligent, image-based, sensing and recording tool that will assist with detailed study of wildlife interactions with various types of structures including power lines.

burying power lines may not be economically or technically feasible. Such options are usually a last resort and only contemplated when an avian resource has been documented to be seriously affected.

Line Marking

Most studies have shown a reduction in collisions and/or an increase in behavioral avoidance at marked lines when compared to unmarked lines, but this can vary with location, type of line marking device, and bird species (Jenkins et al. 2010; Barrientos et al. 2011; see [Chapter 6](#) for detailed information on devices and effectiveness). There are three general categories of line marking devices: aerial marker spheres, spirals, and suspended devices (swinging, flapping, and fixed). Large diameter wire may also improve line visibility and has been used with line marking devices to reduce risk of collision-electrocutions and collisions (see [Chapter 6](#)). Line marking devices are selected based on product availability and durability, cost, ease of installation, compliance and legal issues, spacing and positioning, safety codes related to ice and wind loading, corona effects, esthetics, and potential for vandalism.

Lighting has also been successfully used to reduce collisions. In Washington, a spot light (using the line as a power source) was installed in an uninhabited area to illuminate a section of marked distribution line at night. This effectively reduced collisions of American white pelicans (*Pelecanus erythrorhynchos*) that roost adjacent to the distribution line. The pelicans had collided with the line when flushed during the night by passing trains, even though line marking devices were installed (S. Liguori, PacifiCorp, pers. comm.). In Botswana and South Africa, the Mace Bird Lite, a spiral device with a fluorescent light, has been used to reduce flamingo collisions (Eskom 2003; Eskom Transmission 2009; see [Devices Available in Other Countries](#) on page 97).

When using lighting, the effects of lighting on birds as well as applicable regulations for lighting should be considered (see [Lighting](#) on page 52).

Managing Surrounding Lands

The location and condition of habitat and the surrounding or nearby land uses, such as wetlands and agriculture, and their proximity to power lines influences collision risk (see [Chapter 4](#)). Modifying habitat, land uses, or management practices to influence bird use in strategic areas can reduce collision risk where there is a willing agency or landowner. Sometimes, land management can be less costly and more effective than other line modifications. Options are discussed for conservation, recreation, residential, agricultural, and industrial land uses.

Planting Trees

Where climate and location will allow, planting native trees that will grow to or above the height of nearby power lines, without interfering with line operations, may prevent collisions by forcing birds to gain enough altitude to clear the more visible tree line (Thompson 1978; Raavel and Tombal 1991). For instance, greater white-fronted geese (*Anser albifrons*) flew over power lines more in woodlands than over lines in rice fields in Japan (Shimada 2001), and areas with shorter trees had higher collision rates than areas with taller trees for ptarmigan in Norway (Bevanger and Broseth 2004). For mitigation purposes, tree planting is a long-term strategy because of the time it takes for trees to grow to the desired height; thus, short-term mitigation would likely be necessary in the interim. Because trees can potentially cause operational and reliability problems with lines, a design engineer and a forester should be consulted concerning minimum clearances and line maintenance requirements so appropriate tree species and planting locations can be determined.

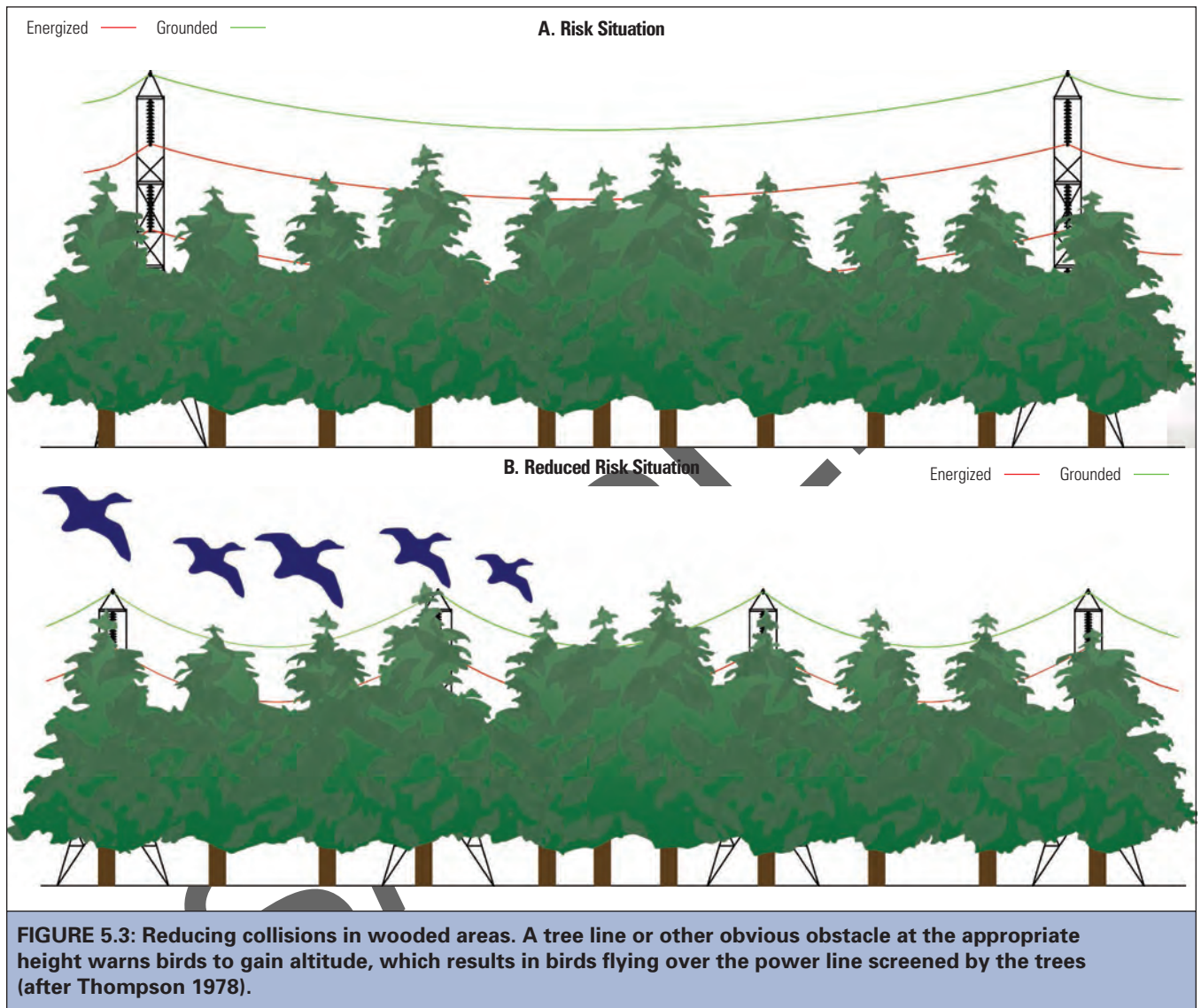


FIGURE 5.3: Reducing collisions in wooded areas. A tree line or other obvious obstacle at the appropriate height warns birds to gain altitude, which results in birds flying over the power line screened by the trees (after Thompson 1978).

Removing Disturbances

Reducing and modifying human access points to decrease the likelihood that human activities will disturb birds where they congregate near power lines can reduce collisions caused by frightening and flushing birds into the power lines (see *Sudden Disturbances* on page 49). Restricting access roads on power line ROWs to utility-related activities is an option that may be open to landowners or

land managers. Conservation area managers and private landowners can limit or prohibit hunting or other high-disturbance activities near power lines. On public access roads, speed limit restrictions and signage indicating bird-use areas may reduce flushing of birds. Crane and waterfowl collisions at Bosque del Apache National Wildlife Refuge in New Mexico were reduced simply by having personnel drive slowly and stop when birds

were on refuge roads, which allowed the birds to leave the area without panic. However, this was not successful enough and the lines were eventually buried. (J. Bradenburg, pers. comm.)

Habitat Modification on Conservation, Recreation, and Residential Lands

Land managers and landowners may be able to manipulate bird habitat to minimize collision risk. For example, when waterfowl need to use two distinct habitat types (e.g., one for feeding and one for roosting), they will generally select those that are closest to each other. If a power line divides those habitats, the collision risk is greater. It may be possible to create both habitat types on one side of the line to reduce the crossing frequency (see [Line Placement](#) on page 66).

Management Practices on Agricultural Lands

Sometimes it is possible to enlist the help of landowners to modify management practices, including the timing of practices that may be attractive to birds, such as burning or flooding fields, where a line is experiencing a high collision rate. For example, in the San Luis Valley, Colorado, farmers plow barley stubble into the ground in preparation for planting in late fall and early spring—times when sandhill and, in the past, whooping cranes (*Grus canadensis* and *Grus americana*) forage in the stubble. The cranes may collide with power lines that border these fields, especially when feeding very close to the line. Through a program sponsored by utility companies, farmers were encouraged to begin plowing the stubble closest to the lines before the birds arrived. This reduced the risk of collisions by causing



© JERRY LIGUORI

FIGURE 5.4: Habitat modifications, such as cooperative programs to encourage earlier plowing of grain stubble, which is attractive to migrating sandhill cranes, may help to reduce collision risk.

the birds to forage farther from the lines where the stubble remained standing (C. Bryant, pers. comm.).

Discourage Bird Use of Industrial Lands

For industrial features such as landfills, cooling ponds, municipal sewage ponds, settling ponds at mines, and other industrial water bodies, property managers can choose from a variety of options that will discourage bird use, such as covering garbage, placing nets over a pond, and using visual or sonic deterrents. Cost, effectiveness, and maintenance should be considered when evaluating bird dissuasion options.

Removing the Shield Wire

Removal of the shield wire from transmission structures (AC or DC) can reduce bird collisions (Beaulaurier 1981; Brown et al. 1987), but is rarely a viable option because it

exposes the lines to lightning strikes, which jeopardize service reliability (Figure 5.5). Shield wires are typically installed on the top of transmission structures to protect the phase conductors from lightning strikes and the electric grid from lightning related power outages. This overhead shielding has proven to be the most effective and economical lightning protection for transmission lines.

The lightning arrester system, one alternative to the shield wire, is effective when used on lines with distribution voltages from 4.2 to 35 kilovolts (kV) and provides sufficient protection to the line and associated equipment. However, lightning arresters may not be a viable option due to cost, design characteristics, and effectiveness for transmission voltages. Their presence would also increase the electrocution risk to birds that perch on power line structures. Because the shield wire often incorporates a fiberoptic communication line, the cost of modifications to the communications system would also need to be included in the analysis.

Changing the Line Configuration

When collisions cannot be reduced by another method such as line marking or managing surrounding lands, the configuration of an existing line can sometimes be changed to minimize collisions. This is usually only possible for new construction or when a line is being rebuilt. Effective design changes would need to be based on studies of the flight behaviors of the bird species at risk (see *Evaluation Studies for Line Modifications*, page 54). In addition, the redesigned section(s) of line would need to be compatible with the rest of the line. Options for changes might include:

- Lowering the height of the lines (e.g., below the tree line)
- Changing the wire diameter
- Bundling wires
- Using spacers to improve visibility



FIGURE 5.5: Removing shield wires can reduce bird collisions but leaves the lines unprotected from lightning strikes and jeopardizes service reliability.

- Rearranging wire configuration (e.g., converting from vertical to horizontal)
- Changing the structure type to increase its visibility
- Decreasing span length (e.g., by adding a pole mid-span)

Rerouting Existing Lines

If all other attempts to reduce significant collision risks to an acceptable level have been exhausted, rerouting may need to be considered. This option would require routing analysis, acquisition of a new or additional ROW, removal and relocation of existing structures, and a scheduled outage for the work. The rerouting analysis should include a comparative risk assessment to evaluate the collision risk for the new line (i.e., whether its risk is measurably lower than that of the existing line) to determine if the rerouting is justified (see *Avian Risk Assessment* on page 65). Environmental benefits and economic cost should be part of the risk analysis. Given the potential land costs and limited options for ROW, together with the cost of structure changes, the economics and logistics of rerouting make this option rarely possible.

Burying Power Lines

Burying power lines with voltages less than 345 kV have been proposed to reduce collisions. However, there are innate characteristics of buried lines that make them only rarely feasible. These include voltage and type of cable, land use patterns, soil conditions, regulatory acceptance, outage risk and reliability requirements, termination facility requirements, length and operating limits, and other environmental concerns. Depending on these characteristics, the cost of buried power lines can vary from 3 to 20 times that of an overhead line (Bumby et al. 2009).

Voltage and Type of Cable

As the voltage increases, costs increase. The type of cable (power line) used also affects the cost. Current options include paper-insulated cable installed in oil-filled pipes, and solid dielectric cables installed in conduits or buried directly in the earth with selected backfill (see *Soil Conditions*, page 63).

Lines ≥ 69 kV are normally installed in pressurized, oil-filled pipes in order to eliminate voids and moisture pockets in the cable insulation. They have an excellent reliability record when properly designed, installed, and maintained. The oil also tends to dissipate the heat generated by the current flow in the cables. If the oil can be circulated under pressure, the capacity and reliability of the cable will be enhanced.

Solid dielectric cables are currently being used for 115-kV and 230-kV applications. They are less reliable than oil-filled pipes. The preferred design is to place them in a conduit so that construction in highly developed areas may move rapidly and the necessary excavation can be covered quickly to reduce the impact and inconvenience to the public. The conduit also provides some physical protection to the cable from accidental excavations.

Land Use Patterns (Urban, Rural, etc.)

In highly developed areas where other utilities are buried (e.g., water, sewer, gas, communication), costs and space are at a premium. In rural areas, some conflict may exist with pipelines, rivers, and lakes (see *Figure 5.6* and *Environmental Concerns* on page 63). In undeveloped areas, geologic formations may prevent economical trenching. In addition, underground lines require termination areas at both ends, similar to small substations, to accommodate the overhead-to-underground transitions.



FIGURE 5.6: Buried power lines may be a solution to bird collisions in some instances, but can cost from 3 to 20 times more than overhead lines and have other environmental impacts.

Soil Conditions

The soils must be able to dissipate heat during periods of high electricity demand. Soil condition also directly affects construction cost (i.e., sandy soils are more easily trenched than rocky soils). In many cases, the spoils from the cable trench have to be hauled away and replaced with heat-dissipating sands to meet the cable design standards.

Regulatory Acceptance

Utility regulatory commissions set rates and control costs. This can have a direct bearing on the feasibility of an underground project. There are documented projects where regulatory commissions have instructed the parties requesting underground construction to pay the difference in installation cost (e.g., Colorado Public Utility Commission Decision No. R82-93).

Outage Risk and Reliability Requirements

Cable failures are difficult to locate and the line must be dug up for repairs and maintenance. Extended outages normally result because of the length of time it takes to locate and repair a fault in the cable. Certain customers, such as hospitals and large industrial or mining operations, have higher reliability requirements than others.

Requirements for Termination Facilities

These include access for large equipment, a fenced area, transition structures, switches and other protective equipment, a transmission line tower or distribution structure, and in some cases a pumping station. Such overhead electrical facilities should be designed to minimize avian electrocution risk (see *Suggested Practices for Avian Protection on Power Lines*, APLIC 2006).

Length and Operating Limitations

As the length of the line increases, the operating limitations are approached and the options to address this will further increase costs.

Environmental Concerns

Environmental damage can result if a buried power line is near or crosses a waterway or is in wetlands or other sensitive habitats (Figure 5.6). If an oil-filled pipe leaks, the oil would contaminate the water and surrounding soils. Ground disturbance during construction, repairs, and maintenance can result in large, permanent displacement of excavated soil and subsequent issues with re-establishing native vegetation and preventing the overgrowth of invasive species. A University of California study (Bumby et al. 2009) found that underground power lines have more environmental impacts than overhead power lines for all categories and most scenarios in southern California.

PLANNING NEW POWER LINES

EVALUATION STUDIES FOR SITING NEW POWER LINES

The potential for avian/power line interactions can be identified and addressed during corridor and routing evaluations such as spatial analysis, field assessment, and avian risk assessment. Methods for these evaluations differ because every route is unique with regard to the species, habitat, and line design. Ornithologists or wildlife biologists knowledgeable in local bird issues should be consulted for pertinent information on bird movement patterns and the presence of species of concern that could be affected by collisions with power lines. Habitats that influence bird presence and movement may present a collision risk and should be identified. Other biological, environmental, and engineering factors that contribute to collision risk should be understood (see [Chapter 4](#)) and considered as well.

Spatial Analysis

The siting process for new lines is in large part a geospatial analysis that facilitates the selection of a route that is compatible with regulatory, land use and availability, environmental, economic, and engineering considerations. Spatial analysis of habitats has been aided by the development of GIS software, which can help identify and characterize risk. GIS is often preferred because it can predict the optimal route by incorporating all the variables under consideration. Features in some GIS software systems can apply segment weighting to help determine the optimal route. GIS software specifically for siting and routing power lines has been developed by the Transmission Line Siting Methodology research project (see EPRI 2006). It uses a multi-step approach that starts with a large study area (corridor) and through various levels of evaluation selects potential routes and a preferred route. GIS software can also be used to create maps, which may be used to

About GIS

GIS (geographic information systems) software incorporates, stores, analyzes, manages, and presents data linked to a specific geographical location. It merges cartography, statistical analysis, and database technology. As a tool, GIS software helps decision-makers understand and predict the relationships between human uses and natural resources such as wildlife and habitat.

rank habitats for their prospective bird use within potential line routes. This approach is especially useful when species of concern occur along a proposed route.

Field Assessment

Field assessment can often minimize collision risks (see [Chapter 4](#)) by identifying high-use bird habitats to avoid during route evaluation. Study designs should be scientifically defensible and developed to meet the needs of the project. Ideally, the following information should be obtained during the field assessment:

- Presence and abundance of bird species in the vicinity of the alternative routes
- Occurrence of species of concern, such as endangered species
- Location of habitat used by birds of concern
- Daily and seasonal use patterns for each species, including a differentiation between migration and daily use

This information can be obtained by using standard bird survey techniques, such as point counts, and from existing avian databases, such as the Christmas Bird Count and eBird (see [Appendix E](#)).

Avian Risk Assessment

Avian risk assessment can be used to characterize the collision risk of a planned or existing line and to prioritize the segments that

need to be modified. Risk assessment is a systematic process for characterizing the probability of an adverse effect occurring (USEPA 1998). It has been adapted for a

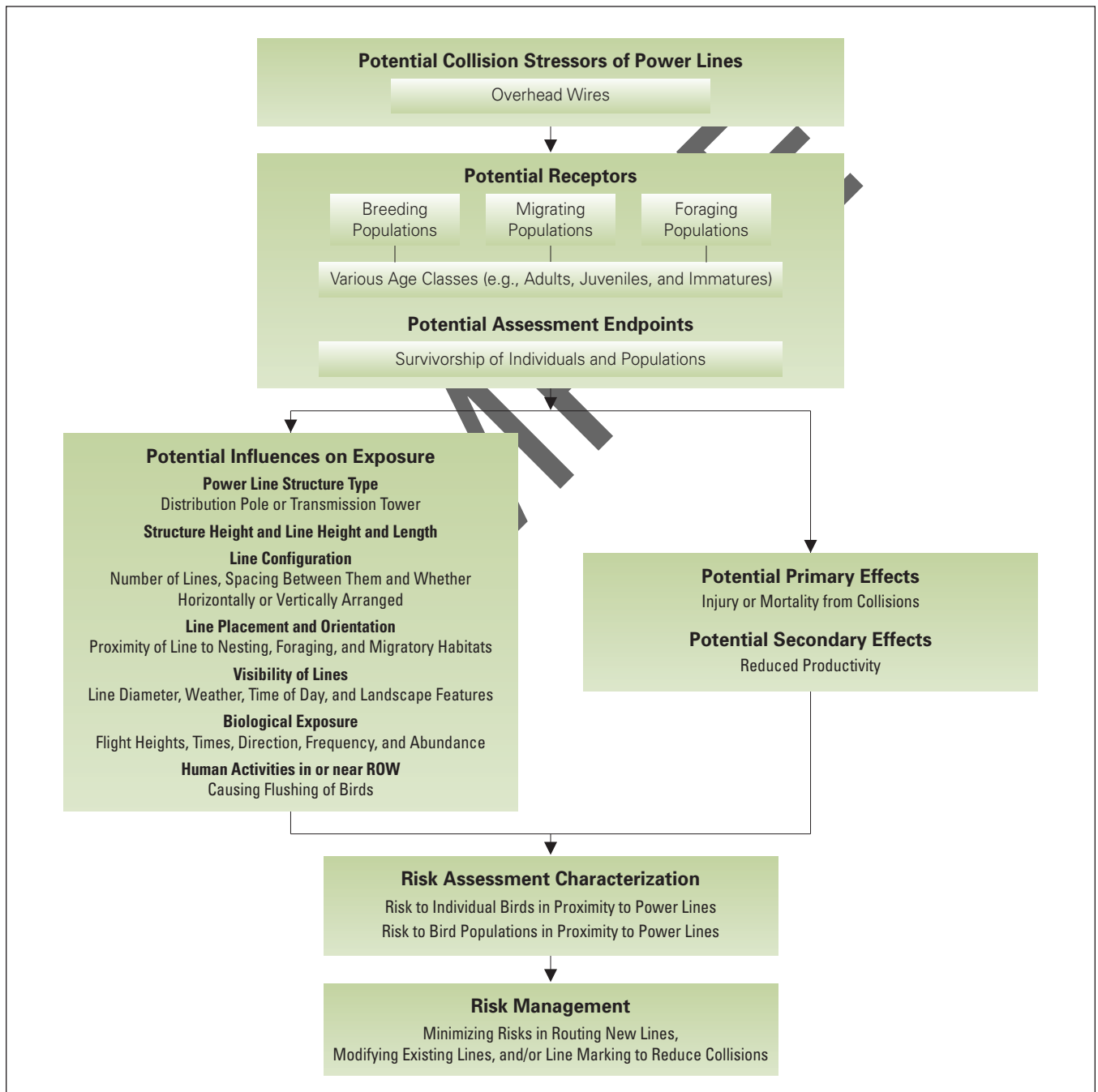


FIGURE 5.7: Conceptual model of avian collision risk assessment.

wide range of applications, including avian/power line interactions. Avian risk assessment in this context evaluates the collision risk that a power line may pose to birds. It includes several steps: problem formulation (e.g., identifying species affected and specific collision issues), characterization of exposure and effects, risk assessment, and risk management. [Figure 5.7](#) presents a conceptual model of avian collision risk assessment.

Both qualitative and quantitative estimates of risk can be used. One or both of these approaches may be appropriate depending upon the type of risk characterization required and the data available.

Qualitative risk assessment provides a non-numeric narrative description of risks. The resulting risk statement is descriptive (not mathematically quantifiable) and provides an estimate of risk, such as low, moderate, high, etc. This approach uses existing information about the proposed site, its ecological resources, literature on the physiology and behavior of species of concern, and reported effects (e.g., accounts of known collision mortality at existing power line projects). Implementing a qualitative methodology does not generally require field studies before construction, but uses site visits to confirm conditions and supplement available information.

Quantitative risk assessments provide estimates of the number of birds anticipated to be at risk to collisions. A quantitative approach accounts for, among other things, the spatial configuration of the stressor (power lines) and the spatial and temporal exposure of the receptor (birds) (i.e., the number of receptors that interact with the stressors in question).¹⁴ Quantitative risk assessments can be developed using literature and other data but, because this method is typically used when greater precision is need-

ed, it is frequently supplemented by site-specific data on power line engineering and/or design and site-specific observations and studies to further assess collision potential.

Sometimes a tiered risk assessment can be used starting with a qualitative assessment and proceeding to a quantitative assessment. For example, if more than one route is being compared for risks, a higher or lower risk ranking may be appropriate using a qualitative approach. If a specific prediction of the amount of mortality is required, a quantitative or modeled approach may be appropriate. Spatial analyses have been used with quantitative modeling to identify and prioritize high risk bird collision areas with varying degrees of success depending upon the quality and quantity of the data (see Heck 2007; Shaw et al. 2010; and Quinn et al. 2011).

OPTIONS FOR MINIMIZING COLLISION RISK DURING ROUTE EVALUATION

Engineering aspects such as line placement, line orientation, and line configuration all contribute to either increasing or decreasing the level of collision risk relative to biological and environmental factors (see [Chapter 4](#)). However, line routing is primarily a function of the origin and destination of the power being carried by these lines (see [Figure 5.8](#)), so other options such as line marking in areas where there is unavoidable collision risk and burying power lines where feasible and warranted may need to be considered.

Line Placement

Broadly, line routing should consider migratory patterns, areas of high bird use, and, if available, historical bird abundance information. On a finer scale, proximity to bird habitats (e.g., wetlands, trees, and other roosting, nesting, and foraging sites) is an important

¹⁴ A stressor is a hazard in the environment that is capable of causing an adverse effect on a receptor. A wildlife receptor can be wildlife individuals, populations, or habitats that are subject to the potential impacts of a stressor.

Terminology Used When Planning New Transmission Lines

For transmission line planning, the following terms may have different meanings to various stakeholders. Figure 5.8 illustrates these terms, which will be used in this manual in the following way.

Planning is the process that identifies the need for a transmission line to deliver electricity from the generation facility to a load or demand center.

Siting determines where the ends of the line need to be—Point A and Point B.

Corridor or study area is usually a rectangular boundary between Points A and B within which the alternative and preferred transmission line routes are plotted.

Alternative routes through the corridor are identified based on a long list of considerations that include endangered species and wildlife habitat. Examples of additional considerations are:

- Cities and towns
- Landowner agreement
- Crossings, such as highway, water, other power lines
- Airports
- Heliports
- Cemeteries
- Communication towers
- Historic places and archaeological sites
- Wetlands
- Land availability

- Land use
- Homes/businesses/schools
- Hospitals
- Parks/recreation
- Pipelines
- Churches
- Wells
- Bridges
- Topography
- Line voltage, design, engineering, and construction

Determining a route through public land is distinctly different than through private land. On public land, an agreement with only a few landowners is necessary; whereas on private land, hundreds of landowners may be involved along with a diversity of land uses and concerns to consider.

The **preferred route** is suggested by the utility. After stakeholder participation, the public utility commission determines the final route, which may be the preferred route, an alternative route, or a combination of the preferred and alternative routes.

The **right-of-way (ROW)** is the land that will be used for the power line. Easements along the ROW give utility crews access to the line for maintenance and are legal agreements, including compensation, between the utility and the landowner.

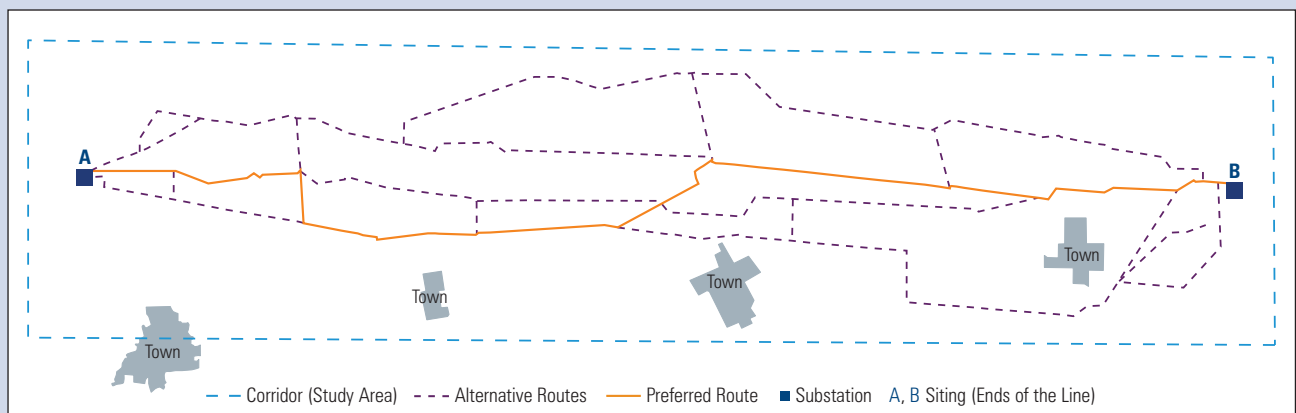
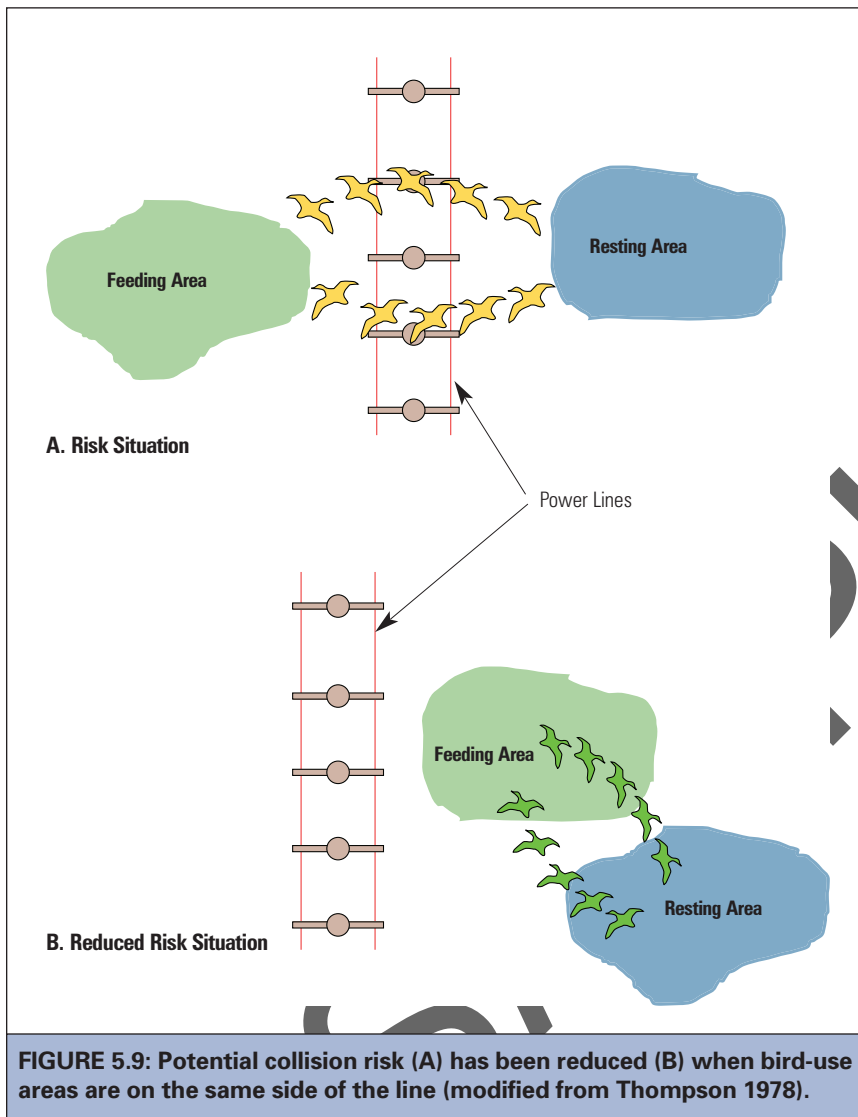


FIGURE 5.8: Schematic of the terminology used when planning new transmission lines.



relative to bird migration and habitat use patterns (see *Spatial Analysis* on page 64).

Line Orientation

Orientation of power lines relative to biological characteristics (e.g., flight behavior, season, and habitat use) and environmental conditions (e.g., weather patterns and topographical features) can influence collision risk. When planning power line routes, features such as mountain ridges, river valleys, and shorelines that are in traditional flight corridors should be considered (Colson and Yeoman 1978; Faanes 1987; Figure 5.10). Power lines that parallel primary bird flight paths pose less risk than a perpendicular orientation (Crowder 2000; Scott et al. 1972; McNeil et al. 1985). For example, the perpendicular orientation of a line relative to a topographical feature poses a greater collision risk to local and migrating birds, whereas a parallel orientation reduces risk.

Where perpendicular orientation cannot be avoided, forest habitats located near power lines can sometimes reduce collision risk (see Figure 5.3). Lines that are at or below the height of nearby trees rarely present a problem to small tree-dwelling birds because of their maneuverability; furthermore, large birds will gain altitude to fly over the tree line and will consequently avoid the power line (Thompson 1978; Raavel and Tombal 1991). For example, a power line crossing a narrow river bordered by trees that are taller than the line is likely to pose a lower collision risk than a broad river crossing because most birds will fly over the tree tops to cross the narrow river valley (CMS 2011a).

consideration when selecting a line route (see Chapter 4). The proximity of power lines to bird take-off and landing areas can affect the risk of collision (Lee 1978; Thompson 1978; Faanes 1987; Brown et al. 1984, 1987; Heck 2007; Quinn et al. 2011). For results of studies on distance of collision mortalities from specific areas, see *Habitat and Habitat Use* (page 44) and *Line Placement* (page 50). Spatial analysis with GIS is useful for evaluating different power line placement options

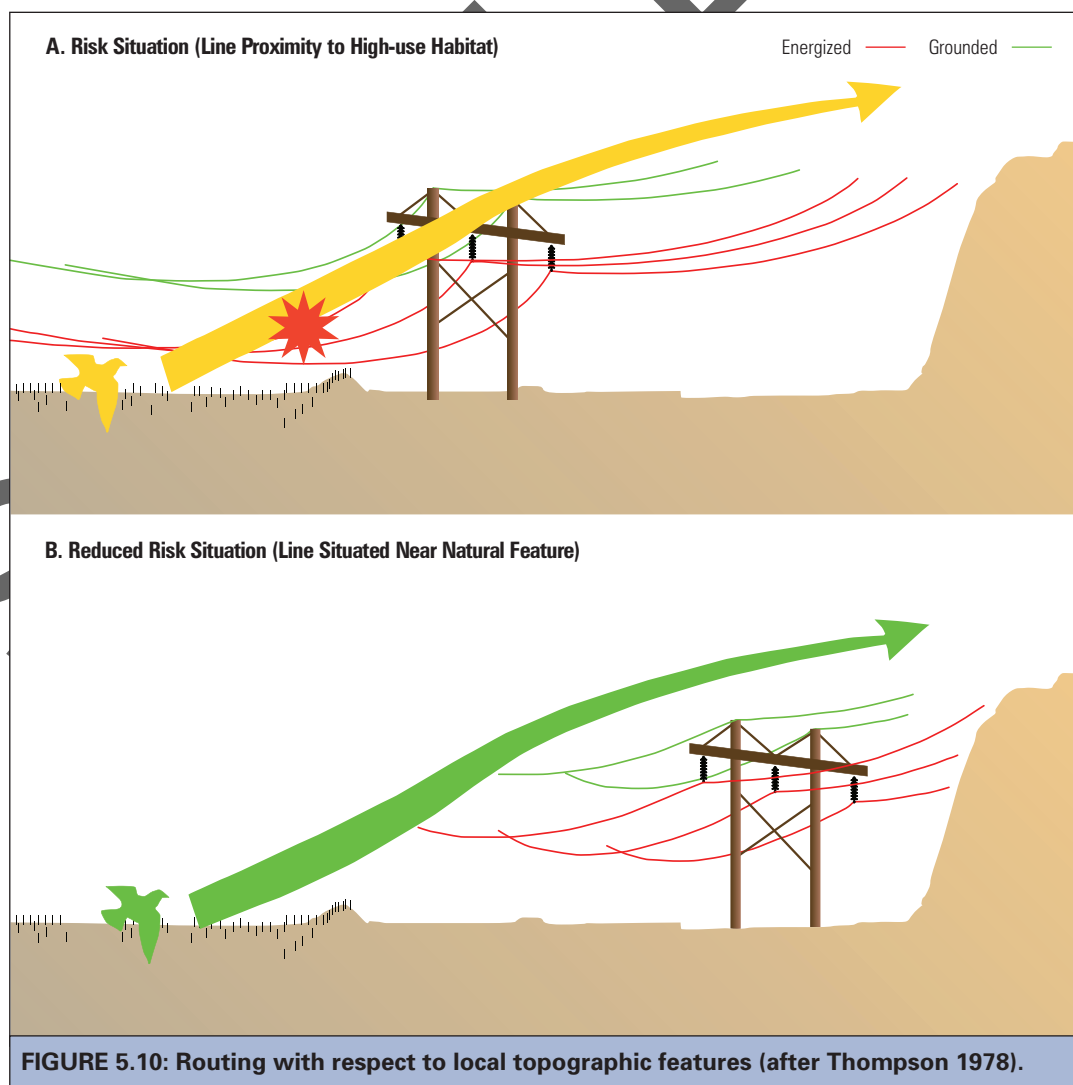
Strong tail winds can be detrimental to birds' ability to maneuver. Brown (1993) suggested that north-south orientation of lines increased collision frequency for cranes and waterfowl in the San Luis Valley, Colorado, because birds crossing them on an easterly heading were often subjected to prevailing westerly winds.

Line Configuration

Line configuration—phase conductors aligned vertically or horizontally and the

number of conductors—is a collision factor that intuitively makes sense, but there are too few studies to draw conclusions. Most researchers agree that keeping the vertical arrangement of multi-conductor transmission lines to a minimum is beneficial because it reduces the height of the collision zone. However, a single-pole, vertical structure is often esthetically more acceptable and requires less ROW width.

Thompson (1978) and others (Bevanger 1998; Crowder 2000; Drewitt and Langston



2008) have suggested that clustering lines (i.e., several power lines sharing the same ROW) may reduce collision risk because the resulting network of wires is confined to a smaller area and is more visible. Birds only have to make a single ascent and descent to cross lines in this arrangement (Figure 5.11 and Figure 5.12). However, when there is decreased visibility, collision risk for birds may increase where several lines are clustered. When there are two shield wires at different

heights, and only the higher one is marked, there may be collisions at the lower unmarked shield wire; both shield wires may need to be marked (S. Liguori, pers. comm.).

Other configuration options include:

- Lowering the height of the lines (e.g., below the tree line)
- Changing the wire diameter
- Bundling wires
- Using spacers to improve visibility

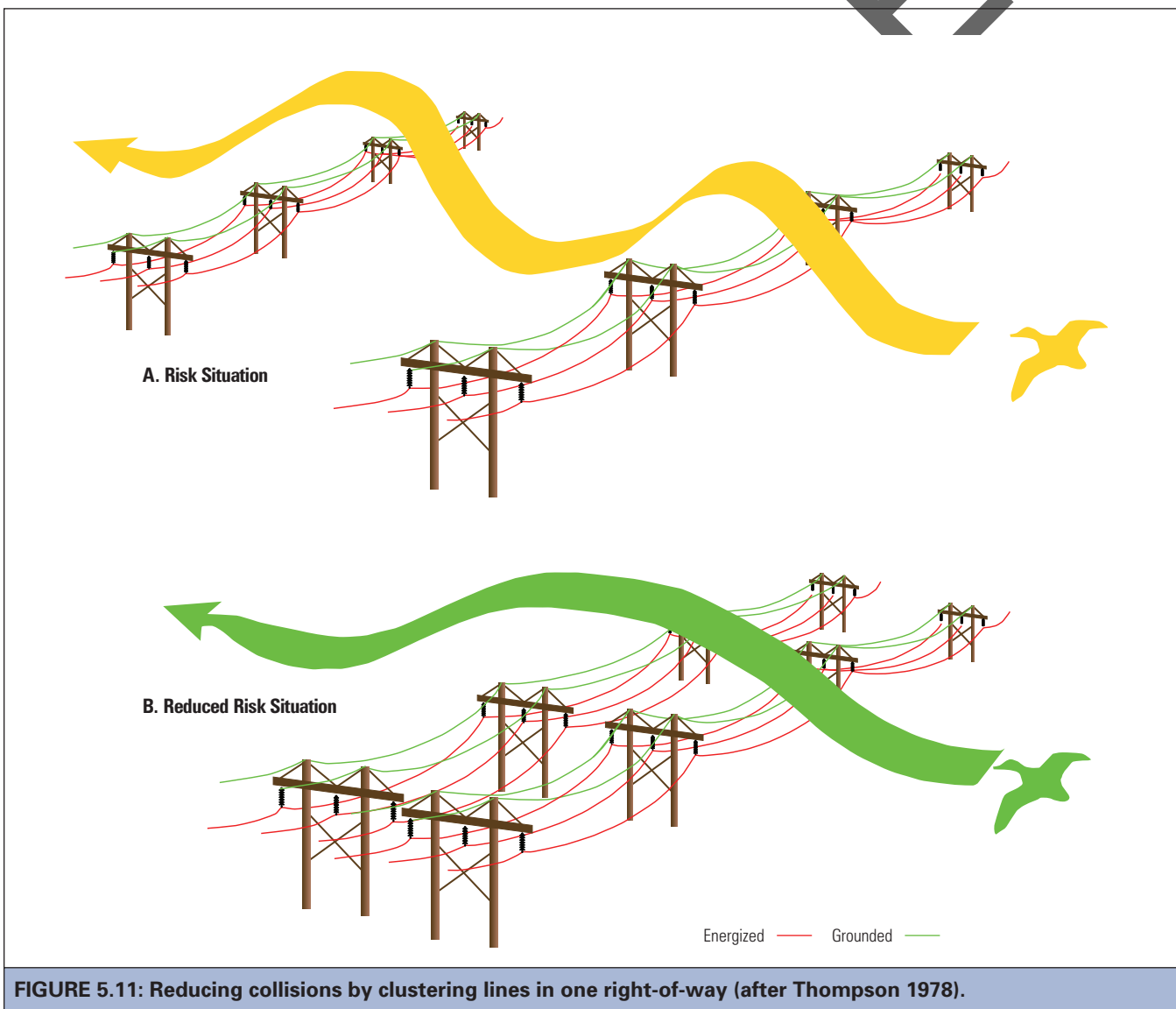


FIGURE 5.11: Reducing collisions by clustering lines in one right-of-way (after Thompson 1978).

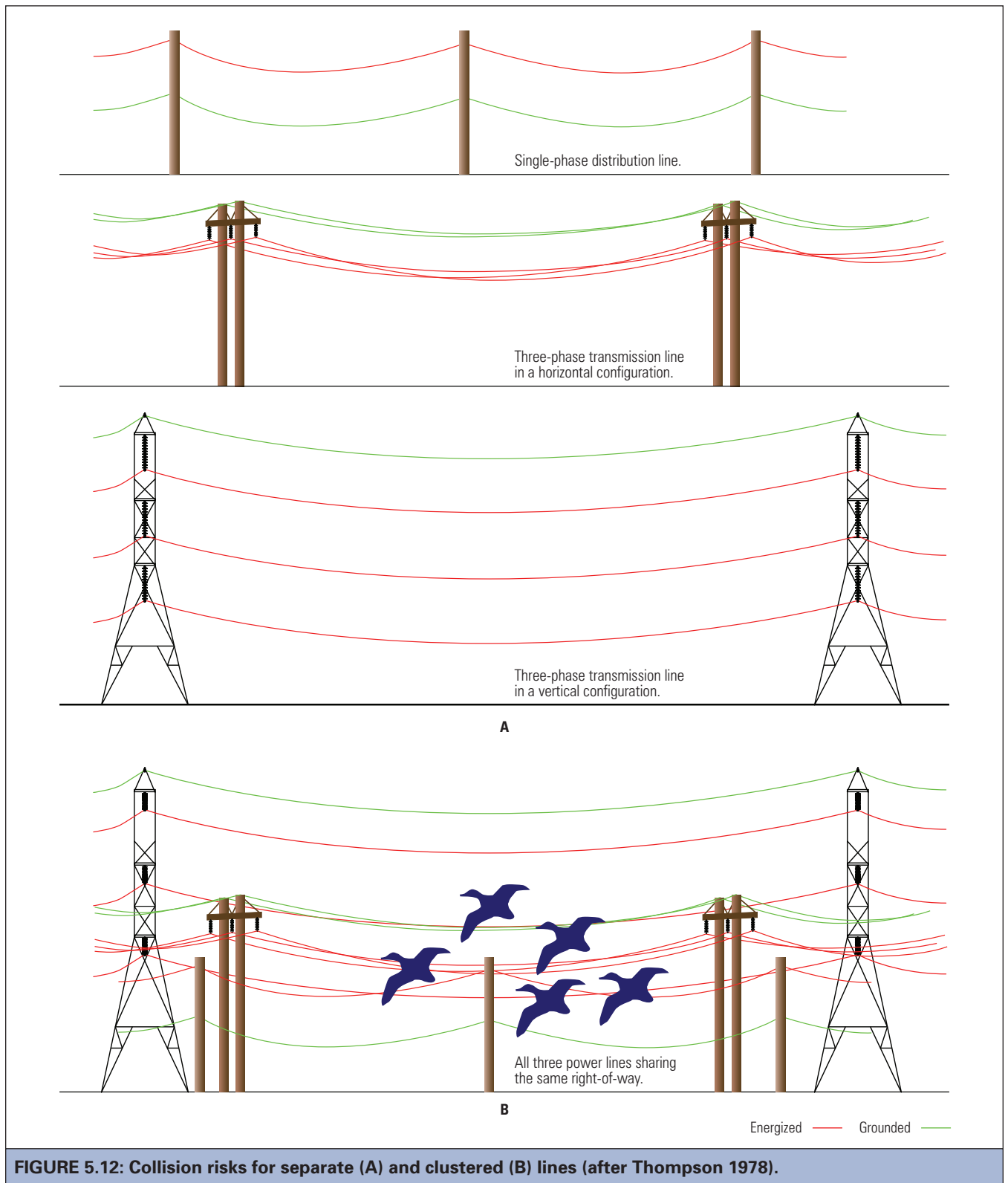


FIGURE 5.12: Collision risks for separate (A) and clustered (B) lines (after Thompson 1978).

- Rearranging wire configuration (e.g., converting from vertical to horizontal)
- Changing the structure type to increase its visibility
- Decreasing span length (e.g., by adding a pole mid-span)

Line Marking

In areas where there is collision risk, line marking devices should be considered. Most studies have shown a reduction in collisions and/or an increase in behavioral avoidance at marked lines when compared to unmarked lines, but this can vary with location, type of line marking device, and bird species (Jenkins et al. 2010; Barrientos et al. 2011; see [Chapter 6](#) for detailed information on devices and

effectiveness). There are three general categories of line marking devices: aerial marker spheres, spirals, and suspended devices (swinging, flapping, and fixed). Large diameter wire may also improve line visibility and has been used with line marking devices to reduce risk of collision—electrocutions and collisions (see [Chapter 6](#)). Line marking options are based on accessibility of the line, product availability and durability, ease of installation, cost, compliance and legal issues, spacing and positioning, safety codes related to ice and wind loading, corona effects, aesthetics, and potential for vandalism.

Burying Power Lines

See the discussion on *Burying Power Lines* under *Options for Modifying Existing Lines* (page 62).

PUBLIC PARTICIPATION TO ADDRESS SOCIAL AND CULTURAL ISSUES

The public may have concerns about power line design and placement, including esthetics, environmental effects, wildlife, and safety. Vandalism is also a persistent problem—electrical equipment and line marking devices can become targets. When a utility is taking steps to minimize collision risk, a public participation program can help build positive relationships, increase public knowledge, identify and respond

to public concerns, and promote responsible behavior (e.g., discouraging vandalism of line marking devices).

WHAT IS PUBLIC PARTICIPATION?

Public participation is different from public relations or public information programs. While a public relations campaign provides information to the public, public participation programs actively engage the public in discussions and decision making. A well-designed public participation program requires the expertise of someone who can communicate technical information in an easily accessible way, facilitate groups, and cultivate trust with stakeholders. For a public participation program to succeed, the commitment and involvement of top management including the key decision makers is essential.

Utilities can use a variety of public participation tools to address social and cultural aspects of collision risk (see EEI 2001 and [Appendix E](#) for resources). Exhibits, signs, publications, web pages, and public announcements can be used to inform the public. Other techniques, such as webcasts, public

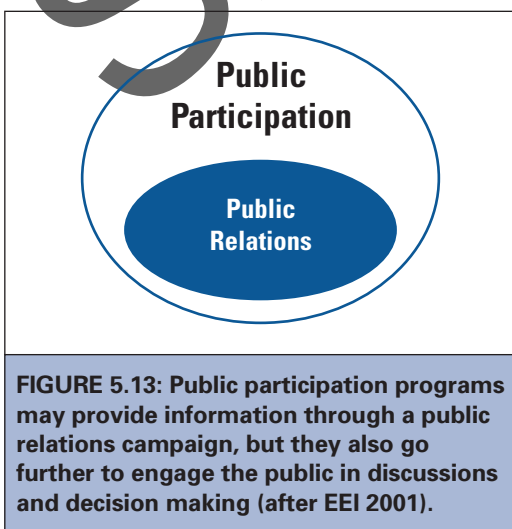


FIGURE 5.13: Public participation programs may provide information through a public relations campaign, but they also go further to engage the public in discussions and decision making (after EEI 2001).

forums, interviews, polls, retreats, citizen advisory panels, social media communications, and workshops promote engagement in the process. All efforts should be based on knowledge of the target audiences, consistent messages, audience participation in building a shared understanding, complete and objective information, and partnerships with support-

ive organizations and businesses. Edison Electric Institute's (EEI) *Introduction to Public Participation* (EEI 2001) is an excellent source of practical information for electric utilities.

BENEFITS OF EFFECTIVE PUBLIC PARTICIPATION

Past experience shows that public participation has a record of creating cooperative working relationships (EEI 2001). According to EEI (2001), public participation:

- Reduces delays and costs associated with controversy and litigation. It often reduces implementation time because the public already supports or accepts the decision.
- Builds a positive relationship with the public, which is important even when it is necessary to make an unpopular decision.
- Develops and maintains credibility even with those who disagree with a given decision. A negative public image in one arena can affect a company's bottom line and trigger opposition in other arenas.
- Creates collaborative problem solving for achieving better and more acceptable decisions. When people believe that utility decisions are being imposed on them, they are more likely to increase their opposition.
- Gathers information from the public that the utility needs to make informed decisions.
- Can improve programs and policies, which will enjoy greater support.
- Can help management understand that technical issues have important social components. Some decisions appear to be technical, but are actually decisions about values.

Case Study: How Public Participation Benefitted Transmission Line Routing

The Project: Florida Power & Light (FPL) Crane-Bridge-Plumosis Transmission Line in southeast Florida (Martin and Palm Beach counties).

The Issue: FPL sought licensing for a 64.4-kilometer (40-mile) transmission line that traversed two densely populated counties. The route chosen for the power line generated some controversy because it included residential areas and a sensitive environmental tract. Alternative routes were proposed and submitted by various non-governmental and neighborhood groups as well as individuals. Continued opposition was expected.

Public Participation: A Citizens Advisory Panel (CAP) was appointed that included members from many different interest groups. The CAP recommended a route that was similar to the one originally recommended by FPL staff and consultants. FPL chose the panel's route.

The Result: The chosen route was initially rejected by the permitting agency but formed the basis of the final approved route.

Benefits of Public Participation: By establishing and working with the CAP, FPL precluded numerous separate meetings with different interest groups. The CAP increased understanding and support for the project despite initial opposition by individual parties. The discussions led to acceptable compromises, and costly appeals and reviews were avoided. In the end, FPL had an approved route that was similar to their preferred route and many members of the CAP felt positive that their input resulted in an improved project. The goodwill developed in the community benefited FPL's public image and set the stage for better relations on future projects.

(Modified from a case study that originally appeared in EEI 2001)

CREATING A STRUCTURED PROGRAM

There are three phases to establishing a successful public participation program: decision analysis, program planning, and implementation. For case studies and a thorough description of how to plan and implement a public participation program use *Introduction to Public Participation* (EEI 2001) as your guide.

Phase 1: Decision Analysis

Clearly identify the decision-making process for the project and establish what role the public will play. Consider who will be affected by the project and if public support for the project is needed. Determine whether regulatory requirements or constraints may limit the opportunities for public participation. A thorough decision analysis will ensure that you engage the public for the right reasons and are not promising something that is not in your power to provide.

Phase 2: Program Planning

Successful participation plans address the needs and goals of both the utility and the public. The steps in creating a participation plan are:

- Identify the issues that will be important and assess the level of controversy of each. Issues and concerns typically focus on one or more of the following: mandate, economics, health, proximity, values, and existing uses of the property or area.
- Identify the parties (stakeholders) that need to be represented in the process. Invite a cross-section of the public including those who will be affected, those with a vested interest, and those who have decision-making power.

- Determine the goals for your public participation program. Goals provide focus and a course of action for the process. Clearly defined goals also make it easier to evaluate the success of the process.
- Define the level of public participation needed and state this clearly when inviting participants. In some cases, the public may be making decisions, while in other cases they may be providing support or recommendations.
- Select appropriate techniques of public participation based on the issues, level of controversy, and audience. Techniques, such as newsletters, web pages, exhibits or news releases provide information, whereas focus groups, meetings, workshops, polls, and interviews foster active public participation and collaboration.
- Outline the decision-making process including all steps from identifying the problem to formulating, evaluating, and selecting alternative approaches.

Phase 3: Implementation

Implement the program according to the collaboratively developed plan. During implementation, participants may see the need to make adjustments or changes, so be flexible and prepared.

Characteristics of Successful Public Participation

Successful public participation programs often do the following:

- Make public participation an integral part of the project, rather than an afterthought.
- Commit to a decision-making process at the outset and maintain that commitment.
- Ensure that the interested public is involved in all phases of decision making: definition of the problem, range of possible alternatives, criteria used to evaluate alternatives, and selection of the final course of action.
- Carefully assess the needs of different audiences and choose techniques appropriate for all groups and for the information that will be collected.
- Ensure that management is engaged and has endorsed the program. This will create a climate of acceptance, which is essential to meaningful public participation.



CHAPTER 6

Line Marking to Reduce Collisions

IN THIS CHAPTER

- Overview of Line Marking Devices
- Effectiveness of Designs
- Marking Constraints and Considerations
- Line Marking Devices
- Large Diameter Wire

A common observation in collision studies is that birds show the ability to avoid a power line if they see the lines early enough. Many of these studies indicate that collision risk can be lowered by more than half and, in some cases, by as much as 80% after lines have been marked. This chapter discusses what is known about line marking, including the different devices, their reported effectiveness, and considerations in their use.

OVERVIEW OF LINE MARKING DEVICES

Studies suggest that the majority of bird collisions occur with the smallest diameter wire, which is typically the shield wire located above the phase conductors on transmission lines (e.g., Savereno et al. 1996) or the phase conductor and neutral wire on distribution lines. Most collisions occur mid-span (e.g., Eskom Transmission 2009). As a result, most of the efforts to reduce bird collisions have focused on marking the shield wires on transmission lines and the phase conductors on distribution lines. As discussed in Chapter 4, different biological, environmental, and engineering factors contribute to birds' ability to see and avoid a power line; each should be considered when choosing among line marking options.

There are three general types of line marking devices: aerial marker spheres, spirals, and suspended devices (swinging, flapping, and fixed). In addition, large diameter wire, though not a marking device, may also improve line visibility and has been used with line marking devices to reduce risk of collision-electrocutions and collisions (see *Large Diameter Wire* on page 100). Since 1994, aerial marker spheres, spirals, and suspended devices have been further developed. Advances include changes to shape, colors and color patterns, and attachments, along with UV resistance, which improves durability and colorfastness. Other designs have been developed, but are not currently available in the United States (see *Devices Available in Other Countries* on page 97).

Because there are few comparative studies, no single device is considered to be the best performing. However, Jenkins et al. (2010) concluded that any sufficiently large line marking device that thickens the appearance of the line for at least 20 centimeters (cm) (7.8 inches [in]) in length and is placed with at least 5 to 10 meters (m) (16.4 to 32.8 feet [ft]) spacing is likely to lower collision rates by 50% to 80%. In addition, the South African Electric Supply Commission (Eskom Transmission 2009) describes its use of spirals and suspended devices on transmission lines and recommends suspended devices over small-diameter spirals because their swinging

or flapping motion makes them more visible and more effective.

Devices can be purchased in a variety of colors, which may be important but there are insufficient comparative studies to provide firm conclusions. In general, what seems to be effective is to alternate the colors to make the lines more obvious (Eskom Transmission 2009). For aerial marker spheres, yellow seems to be the preferred choice over international orange because they provide better contrast in poor light conditions.

Table 6.1 provides a general description of the most commonly used devices that are available in the United States.

TABLE 6.1: Summary of data on line marking devices available in the United States.*

Name [†]	Description	Dimensions	Spacing [§]	General Comments on Effectiveness [§]
<i>Aerial Marker Spheres</i>				
Aerial Marker Spheres or Aviation Balls	Large, colored spheres that attach to wires.	Diameter ranges from 23 cm (9 in) to 137 cm (54 in). The 23 cm (9 in) and 30.5 cm (12 in) are most often used for line marking.	Up to 100 m (328 ft) apart. See Table 6.3 for details.	Reduction in collisions noted in certain situations. Sometimes this marker is used in conjunction with other line marking devices. See Table 6.4 for details.
<i>Spirals</i>				
Spiral Vibration Damper (SVD)	Extruded plastic (PVC) spiral device that fits over the shield wire and distribution conductors.	Various lengths, ranging from 112 to 165 cm (46 to 65 in), to fit different conductor sizes.	Often placed about 3 m (9.8 ft) apart on the shield wire. Stagger on distribution lines to prevent interphase contact.	Reduction in collisions noted. Not as commonly studied as other line marking devices. See Table 6.6 for details.
Bird-Flight™ Diverter (BFD)	Spiral device made from high impact PVC that attaches at one end to the shield wire or distribution conductor and increases in diameter at the other end.	Lengths range from 17.8 to 59.7 cm (7 to 23.5 in). Diameter at the large end ranges from 3.8 to 12.7 cm (1.5 to 5 in).	Ranges from 4.6 to 21 m (15 to 68.9 ft) apart. See Table 6.7 for details.	Shows varying amounts of effectiveness in collision risk reduction and flight behavior alteration. Commonly included in collision studies. See Table 6.8 for details.
Swan-Flight™ Diverter (SFD)	Similar to the BFD, but this device attaches at both ends with the larger diameter spirals in the center.	Lengths range from 50.8 to 116.8 cm (20 to 46 in). Diameter of central spiral ranges from 17.8 to 20.3 cm (7 to 8 in).	Ranges from 15 to 30 m (49.2 to 98.4 ft) apart. See Table 6.9 for details.	Shows varying amounts of effectiveness in collision risk reduction and flight behavior alteration. Commonly included in collision studies. See Table 6.10 for details.

Continued

TABLE 6.1: Summary of data on line marking devices available in the United States.* (cont.)

Name [†]	Description	Dimensions	Spacing [§]	General Comments on Effectiveness [§]
<i>Suspended Devices</i>				
General Designs	Swinging and fixed devices; plastic flapper of various shapes and colors with reflective and glowing surfaces; connected to a clamp that attaches to the power line.	Size and shape varies with device and design.	5 to 30 m (16.4 to 98.4 ft) apart. Staggering devices on parallel lines is recommended. See Table 6.11 for details.	Shows varying amounts of effectiveness in collision risk reduction and flight behavior alteration. Commonly included in collision studies. See Table 6.12 for details.
FireFly™	Swinging and fixed models; rectangular devices with reflective and glowing surfaces; connected to a clamp that attaches to the power line.	Acrylic plastic tag measures 9 cm x 15 cm (3.5 in x 6 in).	4.6 to 15.2 m (15 to 50 ft) apart. See Table 6.13 for details.	Shows varying amounts of effectiveness in collision risk reduction and flight behavior alteration. See Table 6.14 for details.
BirdMark BM-AG	Swinging perforated disk has a reflective center and spins and flutters, it also glows; connected to a clamp that attaches to the power line; perforations allow device more wear resistance in high wind locations.	29.21 cm (11.5 in) long with a 13.33-cm (5.25-in) diameter disk.	4.6 m (15 ft) apart	Mentioned in reviews, but no scientific studies were found.
<p>* Source: Summarized from available literature and Hunting (2002); see Line Marking Devices on page 85 for detailed information and sources.</p> <p>† This table only includes devices that are available in the United States; see Devices Available in Other Countries on page 97.</p> <p>§ Summarized from different sources and studies with varying methodologies, environments, and species; see tables in Line Marking Devices for detailed information and sources.</p>				

EFFECTIVENESS OF DESIGNS

EARLY STUDIES (1960 TO 1994)

In Europe during the 1960s and 1970s, numerous studies addressed the effectiveness of different devices to make power lines more visible so collision rates could be reduced. Most of these studies tested aerial marker spheres (aviation balls) and various types of plastic or rubber strips attached to the lines. These studies found that increasing the visibility of lines resulted in a statistically significant reduction of collision risk.

In 1964, a 275-kilovolt (kV) line near Teeside, England, was marked with 15-cm (6-in) black vanes (flags). Koops and de Jong (1982) reported that this effort was successful

in reducing bird collisions, although no quantitative data were given. Renssen et al. (1975, cited in Beaulaurier 1981) investigated several marking schemes: black, white, and orange aerial marker spheres on the shield wire.

Overall, the dozen or more studies during this period (see lists in Beaulaurier 1981 and Hunting 2002) found that marking devices ranged from no effect to a 60% reduction in collisions. The limitation of these early studies was that most were conducted over a short period of time or they were not held to rigorous experimental protocols. Often, quantifying and comparing flight intensities over marked and unmarked lines were not done.

In addition, the durability of these devices was often very limited because of the plastic and cloth materials used.

LATER STUDIES (1995 TO 2012)

Testing and reporting on the effectiveness of line marking devices have broadened to include the behavioral responses of birds approaching power lines. Hunting (2002), Lislevand (2004), Jenkins et al. (2010), and Barrientos et al. (2011) identified approximately two dozen studies that have focused on the effectiveness of certain devices for selected species. However, most of these studies involved transmission lines, and relatively few have looked at the comparative effectiveness of different devices. Hunting (2002) also concluded that making recommendations on the comparative device effectiveness is not possible due to the variation in study designs.

Barrientos et al. (2011) conducted a meta-analysis of published and unpublished collision studies to evaluate whether line marking reduced the number of collisions and which devices might be more effective. Although they showed that line marking reduced collision rates by 78%, the variability in study designs made it impossible to compare the effectiveness of these devices with different species, in different habitats, in different weather conditions, or on different line configurations. Barrientos et al. (2012), a before-after-control-impact (BACI) study of the effectiveness of two spiral devices (the smaller bird flight diverter and the larger swan flight diverter), concluded that line marking is an effective way of reducing mortality on distribution and transmission lines. Their estimate of overall effectiveness was significant, but not as high as others have reported; more definitive predictions were not possible because of study design and data limitations.

Comparison studies that use the same monitoring time intervals, control for habitat differences, and standardization of the periodicity of carcass searches are necessary to determine the device best suited to a given set of environmental conditions and species intended for protection. The following examples reflect various approaches to studying the effectiveness of line marking devices. (For studies on the effectiveness of each device, see [Line Marking Devices](#) on page 85.)

In San Luis Valley, Colorado, Brown and Drewien (1995) evaluated the effectiveness of two devices: yellow spiral vibration dampers (SVDs) and yellow swinging fiberglass plates with a diagonal black stripe (30.5 cm × 30.5 cm [12 in × 12 in]). Marked segments 0.8 kilometers (km) (0.5 mile [mi]) long were compared with unmarked segments of equal length during spring and fall seasons over a three-year period. They found that SVDs reduced sandhill crane (*Grus canadensis*) and waterfowl mortality by 60% and the swinging plates reduced mortality by 63%. Flight intensities were quantified. Evaluation of the flight behavior of sandhill cranes, Canada geese (*Branta canadensis*), and ducks at marked and unmarked lines indicated that birds reacted to marked lines by increasing their altitude and reaction distance. Although both devices significantly reduced mortality, the swinging plates damaged power lines.¹⁵ The authors suggested that the silhouette of the swinging plate also provided an important benefit in low-light conditions.

In west-central Spain, Janss and Ferrer (1998) studied the effectiveness of three devices (white spiral, series of crossed bands, and thin black strips) on marked and unmarked transmission (380 kV and 132 kV) and distribution (13 kV) lines over a four-year period. The three devices were examined by comparing marked to unmarked spans

¹⁵ The concept of swinging plates has developed into a variety of suspended devices. This new generation of suspended devices has reduced the line-wear problem while maintaining effectiveness.

along the same power line. Monthly carcass searches were conducted without correcting for monitoring biases (see Appendix B). The species exhibiting the highest mortality included bustards, cranes, and shorebirds. The white spiral devices (30 cm × 100 cm [11.8 in × 39.4 in]), similar to a Swan-Flight™ Diverter (SFD), reduced expected mortality by 81% for all birds. The series of two black, crossed bands (35 cm × 5 cm [13.8 in × 1.9 in]) reduced expected mortality by 76% for all birds but not for great bustard (*Otis tarda*). The thin black strips (70 cm × 0.8 cm [28.6 in × 0.3 in]) placed at 12-m (39.4 ft) intervals from the central conductor did not reduce mortality. The authors state that the data could not be used for statistical comparison of effectiveness of the different diverters for specific species.

The Ventura Wildlife Society (2009) conducted a comparative effectiveness study of Bird Flight™ Diverters (BFD) and SFDs at six sites at San Luis National Wildlife Refuge Complex in California. Although approximately 800 hours of observation were made during three winter seasons from 2005 to 2008, few collisions were observed. However, many reactions to power lines were documented, such as altitude changes or sudden changes in flight direction called flutter or flare. The birds exhibited reactions at greater distances from power lines after flight diverters were installed, especially on lines with SFDs. Estimated total collisions were significantly higher for the unmarked control lines than for the lines marked with BFDs or SFDs. The difference in estimated total collisions between control lines and marked lines



FIGURE 6.1: Studies at the San Luis National Wildlife Refuge show that the line marking devices tested work well for most species, the exception being the American coot, which is more vulnerable to collisions because it primarily flies at night.

© JERRY LIGUORI

was even greater when the analysis excluded the American coot (*Fulica americana*), which primarily flies at night and accounted for approximately half of all carcasses found. The study concluded that both diverters were ineffective for the American coot. The study also suggested that site-specific differences can influence the effectiveness of diverters.

Western Area Power Administration conducted a line marking study along 3.2 km (2 mi) of line in 2006, 2007, and 2008 (WAPA 2011). Three line marking devices were used: SFD, BirdMark (solid orange), and FireFly™. The study occurred near Coleharbor, North Dakota, along the Audubon causeway, which separates Lake Audubon on the east from Lake Sakakawea on the west. More than 1,000 bird carcasses (from road mortality and collisions with power lines) and 300 hours of observational data were collected. The results indicated that marking the line decreased the number of observed flyovers for the majority of species; rather than flying over the lines, birds turned and flew parallel to the line. The study also indicated that the differences in device efficacy were minimal.

Regardless of the variability in studies on the effectiveness of devices, most studies have shown a reduction in collisions and/or an

increase in behavioral avoidance when compared to unmarked sections of a line.

MARKING CONSTRAINTS AND CONSIDERATIONS

The choice of marking device is often based on consideration of product availability and durability, cost, ease of product installation, compliance and legal issues, spacing and positioning, safety codes related to ice and wind loading, corona effects, esthetics, and vandalism. Utilities are encouraged to investigate and test products before installing them on a large scale. A general discussion of these considerations is presented here. For specific considerations on each device, see *Line Marking Devices* on page 85. For additional information on what devices may be appropriate, utility companies can consult with the manufacturer and with other utilities.

PRODUCT AVAILABILITY AND DURABILITY

Three general types of devices are available in North America: aerial marker spheres, spirals, and suspended devices. In addition, larger diameter wire can be considered for increasing line visibility. Several distributors supply these devices, so utility managers should consult with their suppliers for available options. Other devices have been developed, but are not currently available in the United States (see *Devices Available in other Countries*, page 97).

The durability of line marking devices and diverters was a commonly reported concern in the 1990s and 2000s. Since then most manufacturers have redesigned these devices to withstand ultraviolet (UV) light degradation, and they have improved the attachment clamps on suspended devices so that damage to the power line is reduced or eliminated—device specifications can be obtained from the manufacturer.

Static devices (such as spirals) and dynamic devices (such as some suspended devices) have different durability. Static devices have

been more durable since they do not have moving parts. However, they have had limited success in South Africa since they can be less visible than dynamic devices. It is assumed that the motion is what makes the dynamic devices more visible. The disadvantage of dynamic devices is that they are subject to wear and have a more limited useful life than static devices. Some dynamic devices can also cause wear damage on the power line (Eskom Transmission 2009). In high wind areas, some devices with moving parts broke within several months (PacifiCorp, unpubl. data).

COST CONSIDERATIONS

Costs will vary with power line access, installation method, type of device, spacing, number of devices needed, and durability of the device. These depend in part on the line design, voltage, and length of line to be marked. Cost will also vary if the marking is done during construction of new lines or retrofitting existing lines. Power lines that are higher or over a water body (e.g., rivers, lakes, etc.) can be difficult to access and require more costly installation methods, such as a boat or helicopter. The durability of each device also varies, which makes long-term maintenance and impacts on line reliability additional considerations in cost estimates. Product cost contributes the least to the overall cost of line marking.

EASE OF INSTALLATION

The various types of line marking devices require different installation techniques: from the ground, bucket truck, boat, helicopter, line trolley, or other means. Some devices can be attached by hand and others need to be attached by a hot stick. Devices that coil onto



© DAVE BOUCHARD, AEP

FIGURE 6.2: A helicopter crew installing line marking devices on a power line.

lines may be easier to install by hand, if possible, than by hot stick. Some, such as suspended devices, may be installed by either one or two people, and a tool may be required for one-person installation.¹⁶ In areas where access to the power line is difficult, product durability may be a more important consideration than ease of installation. For products with a shorter lifespan, the ease of product removal for repairs or replacement should also be considered.

COMPLIANCE AND LEGAL ISSUES

Associated issues must be considered to ensure that the line marking system complies with all applicable company, industry, and legal requirements. Installation must not reduce National Electrical Safety Code (NESC) clearance requirements, cause damage to standard power line hardware, conductors, and/or supporting structures, or affect the line or system reliability. Attachment procedures must adhere to worker and industry safety standards and be compatible with standard industry tools and equipment. Where facilities are shared, the easement documents may have restrictions concerning

additions or modifications. In addition, legal counsel of some utility companies may object to the use of aerial marker spheres for preventing bird collisions because they prefer that the spheres only be used in compliance with Federal Aviation Administration (FAA) regulations to mark hazards to aircraft.

SPACING AND POSITIONING

Spacing and positioning determine the ability of marking devices to increase line visibility, the number of devices needed to mark each span, and how much the marking will add to the ice and wind loading. Over the years, studies have discussed spacing and positioning of devices on power lines. However, there have been no systematic comparisons of devices and their spacing and positioning. The following are general recommendations for spacing and positioning. For specific recommendations on each device, see *Line Marking Devices* on page 85.

Spacing recommendations vary depending on species considerations, environmental conditions, line location, and engineering specifications (e.g., wind and ice loading, conductor size, and the presence or absence of the shield wire). In general, intervals of 5 to 30 m (16 to 98 ft) have been most commonly used and recommended for all but the aerial marker spheres (aviation balls), where a greater spacing is used, and SVDs, where less spacing is used (see [Table 6.1](#)). Jenkins et al. (2010) concluded that any sufficiently large line marking device that increases the diameter of the line by at least 20 cm (8 in) for a length of at least 10 to 20 cm (4 to 8 in) and is placed at intervals of 5 to 10 m (16 to 32 ft) is likely to lower general collision rates by 50% to 80%.

For positioning, Eskom Transmission (2009) recommends marking only 60% of a span, the central portion of the shield wires on transmission lines, since this is where

¹⁶ A utility should consult with its safety department to determine appropriate practices for individual or crew work.

TABLE 6.2: Distance of collision mortalities from the nearest pole (parallel to distribution lines in the right-of-way).*

Taxa or Species	Sample Size	Distance	
		Mean Std Dev	Range
Geese	43	11.9 ± 10.7 m (39 ± 35 ft)	0.6 to 45.7 m (2 to 150 ft)
Ducks	25	16.2 ± 13.1 m (53 ± 43 ft)	0.6 to 48.8 m (2 to 160 ft)
Swans	5	18.6 ± 9.4 m (61 ± 31 ft)	6.1 to 60.9 m (20 to 200 ft)
Raptors	12	37.5 ± 11.9 m (123 ± 39 ft)	18.3 to 54.9 m (60 to 180 ft)
Great blue heron (<i>Ardea herodias</i>)	7	17.4 ± 12.8 m (57 ± 42 ft)	1.5 to 33.5 m (5 to 110 ft)
American white pelican (<i>Pelecanus erythrorhynchos</i>)	16	19.8 ± 15.2 m (65 ± 50 ft)	1.8 to 45.7 m (6 to 150 ft)
Sandhill crane (<i>Grus canadensis</i>)	6	21.9 ± 16.5 m (72 ± 54 ft)	6.1 to 45.7 m (20 to 150 ft)

* Source: PacifiCorp, unpubl. data

most collisions occur. In surveys conducted from 2004 to 2009 in Oregon, California, Idaho, Utah, and Wyoming, PacifiCorp (unpubl. data) found that most waterfowl collision mortalities were found mid-span in the right-of-way (ROW), parallel to distribution lines, at distances of 12 to 18 m (39 to 61 ft) from the nearest pole (Table 6.2); typical span lengths were 91.5 to 121.9 m (300 to 400 ft). Sandhill cranes (*Grus canadensis*), American white pelicans (*Pelecanus erythrorhynchos*), and raptors were found farther from the nearest pole than were other species (PacifiCorp, unpubl. data.). These distances can help direct the placement of line marking devices (Figure 6.3).

Another commonly recommended strategy is to stagger the devices on parallel lines in the same plane to increase the visual density of the marked power line (Figure 6.4 and Figure 6.5). This would also reduce the number of

markers on each individual line and each line's ice and wind loading.

SAFETY CODES: ICE AND WIND LOADING

The NESC identifies minimum safety and engineering standards for power lines within the United States. The NESC ice and wind loading and safety criteria for conductors and supporting structures must be reviewed prior to marking. These guidelines are used when designing a line so the constructed power lines meet or exceed NESC criteria. In addition, some states have adopted additional codes and regulations that further specify design criteria.

When any device is added to an overhead power line, it adds to the weight or loading of the line. Ice or wind adds still more loading to the line and supporting structures. The added weight of the devices and the extra wind and ice loading must not exceed line

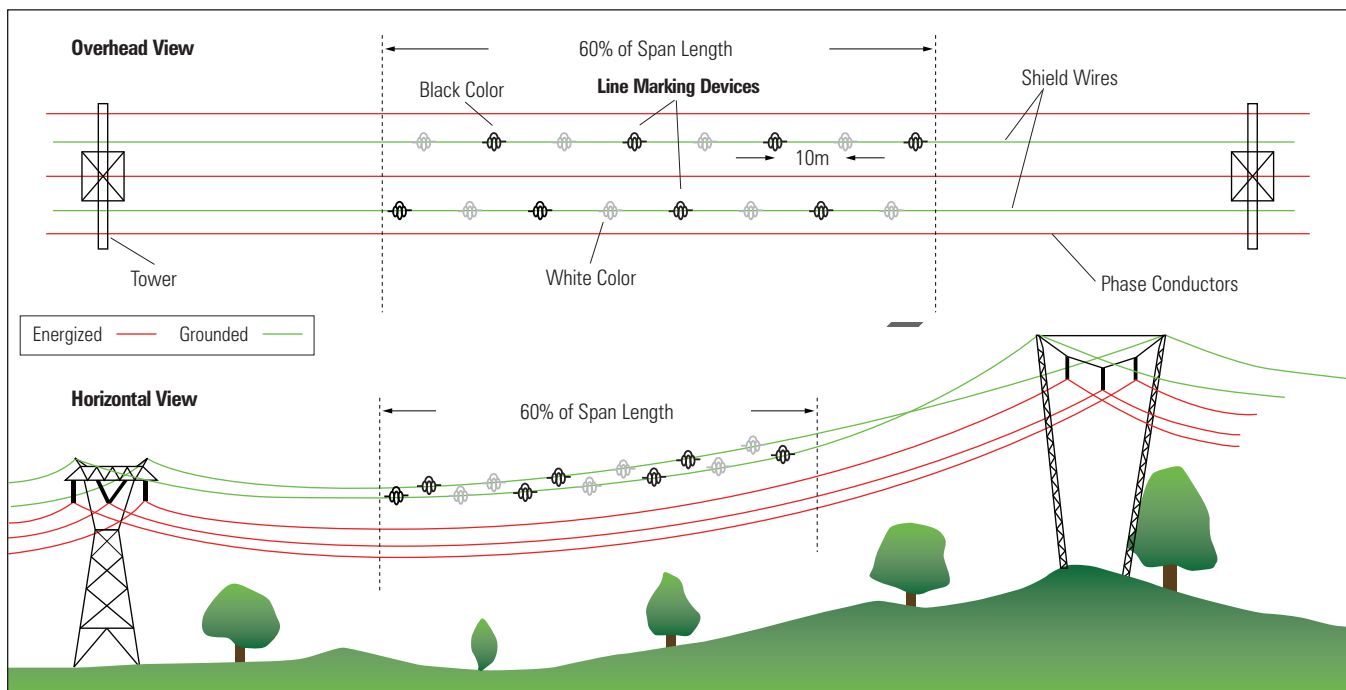


FIGURE 6.3: Positioning of line marking devices on the central portion of two shield wires on transmission lines (after Eskom Transmission [South Africa] 2009).

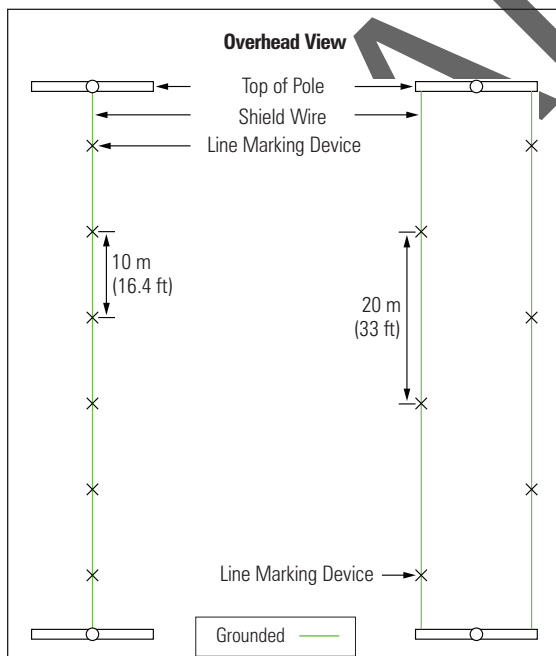


FIGURE 6.4: Positioning of line marking devices on one shield wire or staggered on two parallel shield wires.

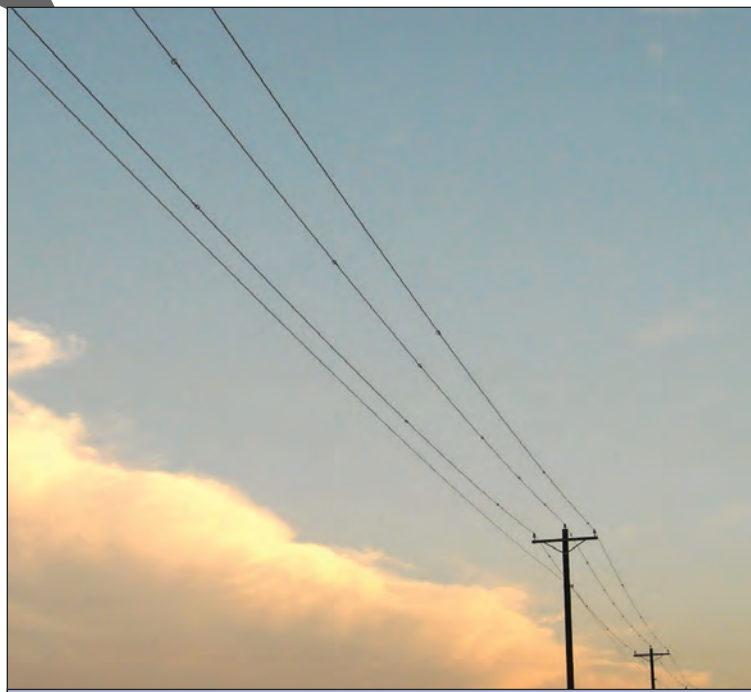


FIGURE 6.5: Line marking devices staggered on a distribution line.



© MANTOBA HYDRO

FIGURE 6.6: When a device is added to a power line, it may add to the loading of the line, which further increases under icy or windy conditions and may also cause problems for deicing operations.

design limits and code requirements or cause additional sag that could lead to interphase contact (one conductor contacting another) and an outage. Consultation with the design engineers is imperative to ensure that adding any type of line marking device will not exceed design criteria. For existing lines, additional loading must be considered when retrofitting with line marking devices. When designing new power lines that may require marking, include allowances for the additional loading of those marking systems to prevent safety criteria from being exceeded.

CORONA EFFECTS

Electric corona occurs when the voltage of a phase conductor, typically 115 kV or greater, ionizes the surrounding air, which also becomes a conductor (Hurst 2004). Corona

can degrade certain materials over time (Hurst 2004). Corona discharges appear as bluish tufts or streamers around the phase conductor, generally concentrated at irregularities on the conductor surface. A hissing sound, an odor of ozone, and local radio interference often occurs. Sharp corners of energized parts and voids, bubbles, and other heterogeneous components within solid materials (e.g., diverters) can cause corona effects.

Hurst (2004) tested several devices (Bird Flapper, FireFly™, BirdMark BM-AG, BFD, and SFD) at three simulated voltages. The study found that most of the devices had very little or no corona at 115 kV (except for some of the suspended devices) but did have corona effects at 230 kV and 345 kV. The best-performing devices at 115 kV were the BFD and the SFD, neither of which had any detectable corona discharge. At 230 kV, the BFD and the SFD had a medium level of corona, whereas suspended devices were characterized with a high level. At 345 kV, all of the devices had a very high level of corona. The corona generally occurred at the point of attachment to the phase conductor and at the top of the Bird Flapper and FireFly.

ESTHETICS

Visual management and esthetics have become concerns related to the construction or modification of power lines. With appearance as a consideration, dull rather than shiny materials are now widely used for overhead lines. Consequently, power lines were designed to blend with the background and be as invisible as possible, particularly in heavily forested areas. However, with growing concern about bird collisions, design goals are changing toward making the line acceptable to people but not invisible to birds.

If the power line is located where the viewshed is an environmental value, such as on or near public land or in residential areas, the addition of line marking devices may become an esthetic issue. For public lands and resi-

Using Public Participation to Address Social Constraints of Line Marking



FIGURE 6.7: Power structures and line markers can become targets for vandalism and a detriment to service reliability. Public participation and outreach programs, like this hotline, may reduce vandalism.

Participation and outreach programs can increase public support for strategies such as line marking and can change or reduce behaviors such as vandalism. This can make it easier for a utility to meet requirements for electrical reliability and customer satisfaction while reducing risks to birds. See [Chapter 5](#) for a discussion on using public participation to address social issues that influence collision risk. [Appendix E](#) includes resources.

dential areas, the marking system should be effective and acceptable in appearance. Public participation and outreach programs can increase support for line marking in areas where viewshed or esthetics are concerns, which could avoid the need for making a trade-off between esthetics and collisions (see [Public Participation](#) in Chapter 5).

VANDALISM

Vandalism is a persistent problem with overhead power lines, particularly from irresponsible shooters. In general, the poles, insulators, towers, signs, and line marking devices can become targets when lines

traverse sparsely populated areas. As a result, electrical conductors have been damaged or severed, and extensive outages have resulted. Repair and replacement costs are ultimately borne by the utility companies and rate-payers. In addition, some customers with critical electricity needs, such as hospitals and mining operations, have had to rely on emergency back-up measures in order to maintain safety levels (A. D. Miller, pers. comm.). When evaluating any line marking system, the potential for vandalism should be addressed. Public participation and outreach programs may help reduce or prevent vandalism (see [Public Participation](#) in Chapter 5).

LINE MARKING DEVICES

AERIAL MARKER SPHERES (AVIATION BALLS)

Aerial marker spheres (or aviation balls) were one of the earliest devices used in an attempt to reduce bird collisions ([Figure 6.8](#) and [Figure 6.9](#)). Originally they were used to warn aircraft pilots of power lines. These large, colored balls are usually attached to distribu-

tion phase conductors or transmission shield wires. They are available in a variety of diameters: 23 cm (9 in) to 137 cm (54 in). The most often used sizes for line marking are 23 cm (9 in) and 30.5 cm (12 in).

Aerial marker spheres are available in a variety of colors, including international orange, gloss white, or gloss yellow. Studies



© P&R TECHNOLOGIES, INC.

FIGURE 6.8: Aerial marker spheres, also known as aviation balls, were designed to make power lines more visible to aircraft operators.



© JERRY LIGUORI

FIGURE 6.9: Aerial marker spheres in use on a power line above a wetland habitat.

regarding the effectiveness of color for warning pilots have shown that international orange is not the most effective color for all lighting conditions (Electrical World 1986). The FAA suggests a combination of international orange, gloss white, or gloss yellow for marking lines for aircraft. In bird collision studies, yellow has been shown useful because it reflects light better at dawn and dusk, and it does not blend in with the background colors as readily as international orange.

Recommended spacing between spheres generally ranges from 30 to 100 m (100 to 328 ft) (Table 6.3 and Table 6.4). For an existing line that crosses water, where the addition of aerial marker spheres may not be suitable, a separate (non-energized) cable for the purpose of holding the aerial markers could be installed. In this application, a larger size cable (visible to birds) should be used so that it does not contribute to bird collisions. This may provide adequate marking to reduce collisions.

TABLE 6.3: Spacing and positioning for aerial marker spheres (aviation balls).*

Device	Utility Industry Practices	Manufacturer Recommendations	Spacing Lengths Used in Experimental Studies [†]
Aerial Marker Spheres (Aviation Balls)	30 to 100 m (98.4 to 328 ft) apart (APLIC)	Spacing is not critical and will depend upon local conditions. The general rule is 20 m (65.6 ft) apart (Preformed Line Products)	Up to 100 m (328 ft) apart. Some studies staggered devices on parallel lines to increase visual density.

* Actual spacing depends on engineering requirements, manufacturer specifications, species involved, and site-specific conditions.

† See Table 6.4 for study details and sources.

TABLE 6.4: Representative studies for aerial marker spheres (aviation balls).

Description/Spacing	Location/Species	Power Line Characteristics	Effectiveness		Reference
			Behavioral Avoidance	Reduction in Collisions	
Yellow spheres with black vertical stripe, 30 cm (11.8 in)/spacing: irregular intervals	Nebraska/sandhill cranes	Transmission, 69 kV to 345 kV	Behavioral avoidance was greater (birds flew higher and reacted sooner) for marked versus unmarked line	Significantly reduced collisions	Morkill and Anderson 1991
Yellow aviation balls with black stripes, 30 cm (11.8 in)/spacing: 100 m (328 ft); staggered on opposing shield wires for a visual effect of 50 m (164 ft)	South Carolina/various waterfowl species	Transmission, 115 kV	Behavioral avoidance was greater (birds reacted sooner) for marked versus unmarked line	Collision rate was 53% lower at marked line	Savereno et al. 1996
Yellow aviation marker ball with 20.3 cm (8 in) black dots/spacing: not provided	Hawaii/shearwaters	—	—	Reduced collisions	Telfer 1999 cited in Bridges et al. 2008

Considerations for Aerial Marker Spheres (Aviation Balls)

- Improper design or installation of aerial marker spheres on phase conductors or shield wires can cause spheres to work loose and slide to the center of the span or be pushed by wind to the end of a span. Line damage from this may cause an outage.
- Aerial marker sphere size should be compatible with the design constraints of the line. For example, very large spheres can be heavy and should only be used on lines that can handle this weight.
- Adding aerial marker spheres can affect line tension and structure design more than other devices, particularly in areas where heavy ice and wind loading occurs. Accommodating the additional loading could affect construction costs.
- When installed on higher voltage conductors, there can be corona damage (depending on the type of marker balls). To avoid corona damage, marker balls designed for installation on higher voltage lines, though more costly, should be used.
- Spheres are moderately labor-intensive to install on an existing line, but less costly when added to a new line during construction.
- Although aerial marker spheres are more costly per unit than spirals, the overall cost of marking new or existing lines would be about the same because fewer spheres would be required.
- The legal counsel of some utility companies objects to the use of aerial marker spheres to prevent bird collisions. They prefer that spheres be used only in compliance with FAA regulations to mark hazards to aircraft.
- Depending upon the location, aerial marker spheres can be targets for irresponsible shooters.
- The size and number of aerial marker spheres used may result in visual degradation of environments where esthetics are important (tourist areas, scenic mountain views, historic areas, etc.)

SPIRALS

Spirals available in the United States include spiral vibration dampers (SVDs), Bird-Flight™ Diverters (BFDs), and Swan-Flight™ Diverters (SFDs).

Spiral Vibration Damper (SVD)

Spiral vibration dampers (SVDs) are pre-formed PVC spirals that were designed to reduce line vibration (aeolian vibration), but were also found to increase line visibility and

to reduce collision risk. Aeolian vibration is induced by low-velocity winds of 4.8 to 12.9 km per hour (3 to 8 mi per hour)

(Figure 6.10). SVDs change the airfoil of a power line under normal and icing conditions to reduce conductor gallop.

SVDs are available in various lengths, ranging from 112 to 165 cm (46 to 65 in), to fit different wire sizes. Standard SVDs are made of solid thermal plastic. They are available in gray or yellow with UV stabilizers that help the devices retain color, flexibility, and durability when exposed to extreme sunlight and weather conditions. They are also available in a yellow, high-impact PVC.

SVDs are often placed about 3 m (9.8 ft) apart on transmission line shield wires (Table 6.5 and Table 6.6). For distribution lines, to prevent interphase contact and increase line visibility, SVDs should be staggered so that every third one is on an alternate phase conductor.



FIGURE 6.10: Spiral vibration dampers act to reduce line vibration, and they also make power lines more visible to birds.

© JERRY LIGUORI

TABLE 6.5: Spacing and positioning for spiral vibration dampers (SVDs).*

Device	Utility Industry Practices	Manufacturer Recommendations	Spacing Lengths Used in Experimental Studies [†]
Spiral Vibration Damper (SVD)	2.7 m (9 ft) on the shield wire. On distribution phase conductors, stagger SVDs to prevent interphase contact. (APLIC)	–	3.3 m (10.8 ft) apart (Brown and Drewien 1995)

* Actual spacing depends on engineering requirements, manufacturer specifications, species involved, and site-specific conditions.

[†] See Table 6.6 for study details and sources.

TABLE 6.6: Representative studies for spiral vibration dampers (SVDs).

Description/Spacing	Location/Species	Power Line Characteristics	Effectiveness		Reference
			Behavioral Avoidance	Reduction in Collisions	
Yellow spiral vibration dampers, 1.27 cm × 112 to 125 cm (0.5 in × 44 to 49.2 in) / spacing: 3.3 m (10.8 ft)	Colorado/ waterfowl and sandhill cranes	Distribution, 7.2 kV Transmission, 69 to 115 kV	Reacted sooner and changed flight patterns in marked versus unmarked lines	Reduced mortality by 60%	Brown and Drewien 1995

Considerations for Spiral Vibration Dampers

- When installed on triangularly spaced distribution lines, SVDs should be staggered on all three phase conductors. Despite their light weight, if they are only applied on the top or ridge phase conductor, wind or ice may make the top phase sag, which may cause interphase contact.
- When installed on a single shield wire, given the relatively light weight of SVDs, the rate of coverage, and the distance between the shield wire and the phase conductors, line sag on the shield wire would rarely present an issue.
- SVDs are not recommended for use on transmission phase conductors (AC or DC) with voltage ≥ 230 kV because of corona effects (see *Corona Effects*, page 84). However, future design materials may address this issue.
- Installation of SVDs is moderately labor intensive on lower-height distribution lines and more so on transmission lines that range from 15.2 to 59 m (50 to 195 ft) above the ground.



FIGURE 6.11: The Bird-Flight™ Diverter is a spiral device made of PVC.

© PREFORMED LINE PRODUCTS, INC.

Bird-Flight™ Diverter (BFD)

BFDs are preformed, increasing-radius spirals made of extruded, high-impact PVC (Figure 6.11 and Figure 6.12). One end of the spiral

grips the power line while the radius quickly increases toward the other end of the spiral. BFDs were developed in Great Britain and have been used in Europe since the early 1970s and more recently in the United States and South Africa. They are also called “small pigtails” in South Africa (Eskom Transmission 2009). Since 1994, more designs have become available.

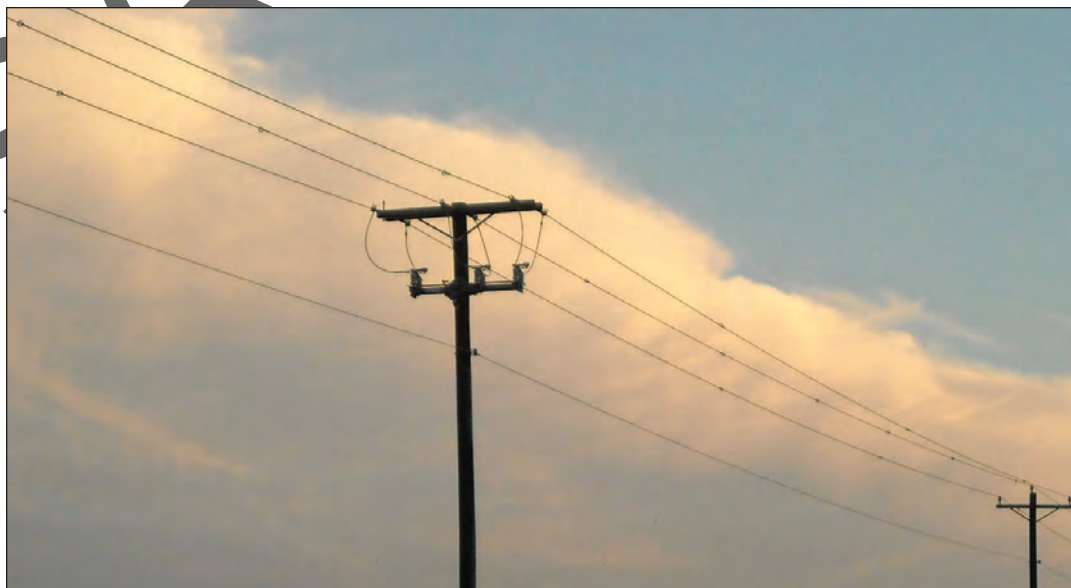


FIGURE 6.12: Bird-Flight™ Diversers installed on a distribution line.

© DAVE BOUCHARD, AEP

TABLE 6.7: Spacing and positioning for Bird-Flight Diverter (BFDs).*

Device	Utility Industry Practices	Manufacturer Recommendations	Spacing Lengths Used in Experimental Studies [†]
Bird-Flight Diverter (BFD)	4.9 to 15.2 m (16 to 50 ft) (APLIC) 10 m (32.8 ft), staggered (Eskom) 21 m (68.9 ft) (Iberdrola)	4.6 m (15 ft) apart depending upon local conditions (Preformed Line Products)	5 m (16.4 ft), 10 m (32.8 ft), 15 m (49.2 ft), and 20 m (65.6 ft). Some studies staggered devices on parallel lines to increase or maintain visual density and to reduce and distribute loading equally.

* Actual spacing depends on engineering requirements, manufacturer specifications, species involved, and site-specific conditions. Manufacturer recommendations are the closest spacing that would be required.
[†] See Table 6.8 for study details and sources.

Various sizes of BFDs are available to fit different line diameters. The lengths can range from 17.8 to 59.7 cm (7 to 23.5 in). The diameter of the spiral at the large end of the diverter ranges from 3.8 to 12.7 cm (1.5 to 5 in). UV stabilizers are added to the PVC to protect BFDs from sunlight. They are produced in a variety of colors, such as yellow, orange, red, green, brown, gray, and black, and some glow.

Spacing recommendations for BFDs vary (Table 6.7 and Table 6.8). In the Netherlands, wires have been marked in bird-collision zones using 10 cm (3.9 in) spirals at 5 m (16.4 ft) intervals. This reportedly has an average mortality reduction of approximately 90% (Koops 1993). For the United States, one manufacturer (Preformed™ Line Products) recommends 4.6 m (15 ft) spacing intervals depending upon local conditions. In studies conducted in the Netherlands, marking devices have been staggered on parallel shield wires so that the line marking devices appear to be 5 m (16.4 ft) apart (Koops 1979; Koops and de Jong 1982; Koops 1987). On each shield wire, however, they are 10 m (32.8 ft) apart. Staggering line

marking devices on alternate lines reduces the loading that a single marked line would otherwise have to bear.

Considerations for Bird-Flight Diverter

- BFDs add some aeolian vibration stabilization since their profile changes the airflow over the line.
- BFDs are not recommended for use on transmission line phase conductors (AC or DC) with voltage ≥ 230 kV because of corona effects (see *Corona Effects*, page 84). However, future design materials may address this issue.
- Eskom has used BFDs in South Africa for years with no reports of mechanical failure (van Rooyen 2000) although some red PVC devices have faded.
- BFD installation is labor intensive whether by bucket truck, boat, helicopter, or line trolley. Robotic installation devices are being developed.

TABLE 6.8: Representative studies for Bird-Flight Diverters (BFDs).

Description/Spacing	Location/Species	Power Line Characteristics	Effectiveness		Reference
			Behavioral Avoidance	Reduction in Collisions	
White BFD, 5 cm (1.9 in) diameter/spacing: 5 m, 10 m, and 20 m (16.5, 32.8, and 65.6 ft) White BFD, 10 cm (3.9 in) diameter/spacing: 15 m (49.2 ft)	Netherlands/ various species	—	—	When spaced at 20 m (32.8 ft), they reduced collisions by 58%. Total mortality was reduced by 57% to 89%, depending upon the size and spacing	Koops 1987; Koops and de Jong 1982; Koops 1993 (cited in Janss and Ferrer 1998)
Red spiral BFD, 30 cm (11.8 in) maximum diameter, 1 m (3.3 ft) long/spacing: 10 m (32.8 ft)	Spain/various species including cranes and bustards	Transmission, 380 kV with dual shield wires	61% reduction in birds crossing the lines, more birds flying over, fewer flying through lines	60% reduction in collisions	Alonso et al. 1994
Yellow and gray BFD	Indiana/ waterfowl	Transmission, 345 kV		Reduced bird collision by 73.3% compared to unmarked lines	Crowder 2000
Yellow PVC BFD spirals, 25 cm (9.8 in) diameter, 80 cm (31.5 in) length /spacing: 10 m (32.3 ft); staggered on both shield wires	Colombia/ night flying rallids, herons, and ducks	Transmission, 500 kV	Birds detected BFD line at a greater distance than unmarked line, fewer flew at conductor height	Reduction in collision frequency for marked versus unmarked lines, but collision rate was highly variable regardless of line condition	De La Zerda and Roselli 2003
Yellow and gray BFD/ spacing: 4.6 m (15 ft); staggered on 3 phase conductors	California/ waterfowl	Distribution	Birds exhibited greater reactive distances	Reduced waterfowl collisions, but not coot collisions (coots fly at night)	Ventana Wildlife Society 2009
Small spirals, 10 cm (3.9 in) diameter, 24 cm (9.4 in) long/spacing was not provided	Spain/various species including bustards, storks, and doves	Distribution and transmission	—	Reduced collisions overall after line marking (9.6%)	Barrientos et al. 2012

Swan-Flight™ Diverter (SFD)

The SFD is another spiral design, which is also called a Double Loop Bird Flight Diverter (Figure 6.13 and Figure 6.14). SFDs have two gripping ends and a central spiral with a larger diameter.

Sizes are available to fit different conductor diameters. The lengths can range from 50.8 to 116.8 cm (20 to 46 in). The diameter of the central spiral can range from 17.8 to 20.3 cm (7 to 8 in). SFDs are extruded in yellow and gray high-impact PVC with UV



FIGURE 6.13: The Swan-Flight™ Diverter is a double-ended spiral device.



FIGURE 6.14: Swan-Flight™ Diverters installed on the phase conductors of a distribution line.

stabilization. Gray is the standard color but SFDs are available in: black, blue, brown, green, purple, red, orange, and pink, and some that glow.

Spacing depends upon local conditions (Table 6.9 and Table 6.10).

Considerations for Swan-Flight Diverters

- SFDs can be used on the shield wires of high-voltage lines.
- SFDs on the line add some aeolian vibration stabilization since their profile changes the airflow over the line.
- SFDs are not recommended for use on transmission line phase conductors (AC or DC) with voltages ≥ 230 kV because of corona effects (see *Corona Effects*, page 84). However, future design materials may address this issue.
- Wind and ice loading should be considered, as these have been a concern in Canada and the northern United States (N. Heck, pers. comm.).
- Colors of some SFDs may fade.
- Installation is labor intensive whether done from bucket truck, boat, helicopter, or line trolley. Robotic installation devices are also being developed.

TABLE 6.9: Spacing and positioning for Swan-Flight Diverters (SFDs).*

Device	Utility Industry Practices	Manufacturer Recommendations	Spacing Lengths Used in Experimental Studies [†]
Swan-Flight Diverter (SFD)	15.2 m (50 ft) (APLIC) 21 m (68.9 ft) (Iberdrola)	Spacing is not critical and will depend upon local conditions. The recommended ranges are 10 to 15 m (32.8 to 49.2 ft) (Preformed Line Products) up to 30 m (98.4 ft) (FCI)	5 m (16.4 ft), 10 m (32.8 ft), and 15 m (49.2 ft). Some studies staggered devices on parallel lines to increase visual density and distribute loading equally.

* Actual spacing depends on engineering requirements, manufacturer specifications, species involved, and site-specific conditions.
[†] See Table 6.10 for study details and sources.

TABLE 6.10: Representative studies for Swan-Flight Diverters (SFDs).

Description/Spacing	Location/ Species	Power Line Characteristics	Effectiveness		Reference
			Behavioral Avoidance	Reduction in Collisions	
White spirals (SFD), 30 cm (11.8 in) diameter/ spacing: 10 m (32.8 ft)	Spain/various species including cranes, storks, and bustards	Various size distribution and transmission lines	–	Effective at reducing collisions	Roig-Soles and Navazo-Lopez 1997
White polypropylene spirals, 1 m (3.3 ft) long, 30 cm (11.8 in) maximum diameter/spacing: 10 m (32.8 ft); staggered on 2 shield wires for a visual effect of 5-m (16.4-ft) intervals	Spain/cranes	Transmission, 380 kV and 132 kV Distribution, 13 kV	–	Small sample size did not permit specific species evaluation. Reduced mortality for common cranes. The reduction in actual versus predicted mortality for all birds was 81%	Janss and Ferrer 1998
Yellow and gray SFD/spacing was not provided	Indiana/ waterfowl	Transmission, 345 kV	–	Reduced collisions by 37.5% on marked lines compared to unmarked lines	Crowder 2000
Yellow SFD/ spacing: 15.2 m (50 ft); staggered on parallel wires for a visual effect of 7.6-m (25-ft) spacing	Wisconsin/ trumpeter swans (<i>Cygnus buccinator</i>)	Distribution, 23.9 kV	–	Eliminated collisions completely	Rasmussen 2001, cited in Hunting 2002
Red SFD, 32 cm (12.6 in) for the gripping section and 17.5 cm (6.9 in) for the outside diameter of the central spiral/spacing: 5-m (16.4-ft) intervals on shield wire	England/ mute swans (<i>Cygnus olor</i>)	Transmission, 132 kV	–	Reduced collisions	Frost 2008
Gray SFD/ spacing: 4.6 m (15 ft), staggered on 3 phase conductors	California/ waterfowl	Distribution	Birds exhibited greater reactive distances	Reduced waterfowl collisions, but not coot collisions (coots fly at night)	Ventana Wildlife Society 2009
Large spirals, 35 cm (13.8 in) diameter, 1 m (3.3 ft) long/ spacing was not provided	Spain/various species including bustards, storks, and doves	Distribution and transmission	–	Reduced collisions overall after line marking (9.6%)	Barrientos et al. 2012



ESKOM 2009

FIGURE 6.15: Examples of suspended devices (swinging and fixed).

SUSPENDED DEVICES (SWINGING, FLAPPING, AND FIXED)

There are several types of suspended devices including general designs and branded designs (e.g., FireFly™ and BirdMark BM-AG), which are discussed separately on [page 95](#) and [page 96](#). They have a clamp that attaches to the power line so that the device can move in the wind. Some are designed to swing, flap, and spin, while others, for use in high wind locations, are nearly immobile but do allow some motion. Some have reflective and glow-in-the-dark properties.

General Designs

Suspended devices have a polycarbonate, UV stabilized, plastic flapper (swinging or fixed) connected to a clamp that attaches to the power line (Figure 6.15). The movement and reflectivity of the device enhances the visibility of the line. Suspended devices are available in many colors and shapes with panels that reflect visible and UV light and glow. They can be attached to distribution phase conductors up to 40 kV and to shield wires up to a diameter of 1.9 cm (0.75 in) (Table 6.11 and Table 6.12).

TABLE 6.11: Spacing and positioning for general designs of suspended devices.*

Device	Utility Industry Practices	Manufacturer Recommendations	Spacing Lengths Used in Experimental Studies [†]
Swinging or fixed device	5 m (16.4 ft), staggered (Eskom)	Staggering devices on parallel lines is recommended. The general spacing rule is 10 to 15 m (32.8 to 49.2 ft) (Preformed Line Products).	—

* Actual spacing depends on engineering requirements, manufacturer specifications, species involved, and site-specific conditions.

TABLE 6.12: Representative studies for general designs of suspended devices.

Description/Spacing	Location/Species	Power Line Characteristics	Effectiveness		Reference
			Behavioral Avoidance	Reduction in Collisions	
Swinging or fixed device (specifications and spacing not provided)	South Africa/ bustards and cranes	Distribution, 22 kV Transmission, up to 440 kV	– –	Reduced collisions More effective than the BFD	van Rooyen 2000; Anderson 2001; McCann 2001
Yellow fiberglass swinging plate, 30.5 x 30.5 cm, (12 x 12 in) with a black stripe/ spacing: 20 to 30 m (65.6 to 98.4 ft) on shield wires or center phase conductor	Colorado/ sandhill cranes and waterfowl	Distribution, 7.2 kV Transmission, 69 kV to 115 kV	Birds reacted earlier and flew higher over marked lines than unmarked lines	63% reduction in mortality rates overall, but there was considerable seasonal variation. Over 30% of collisions in fall occurred at night.	Brown and Drewien 1995

FireFly™

There are several types of FireFlies, two of which (the FireFly FF and the FireFly HW) are designed as suspended devices (Figure 6.16). FireFlies have a strong spring-loaded clamp that attaches to the line so that the device can swing. The device increases the line profile slightly, but its motion and

reflectivity attract attention and alert birds of the line's presence.

The FireFly FF has an acrylic plastic tag that measures 9 cm x 15 cm (3.5 in x 6 in), is 3 mm (0.13 in) thick, and is covered with yellow and orange reflective tape and photo-reactive coatings. They are UV light stabilized and constructed to be highly reflective during the day. According to the manufacturer they glow for up to 10 to 12 hours after sunset. They are attached to the clamp by swivels so they swing and spin in the wind.

The FireFly HW is similar in size to the FireFly FF but the HW model's plastic tag does not swivel and is designed to withstand higher, sustained winds. The manufacturer claims similar effectiveness. Results from installation in a high raptor use area on a new power line in central California have shown these devices to be effective without any damage to the line or failure of the devices (M. Schriener, pers. comm.).

FireFlies have been attached 4.6 to 15.2 m (15 to 50 ft) apart. For lines with parallel shield wires, they can be staggered so that the device density appears greater, e.g., when spaced at 12.2 m (40 ft) on each shield wire and staggered, they appear to be 6.1 m (20 ft) apart (Table 6.13 and Table 6.14).

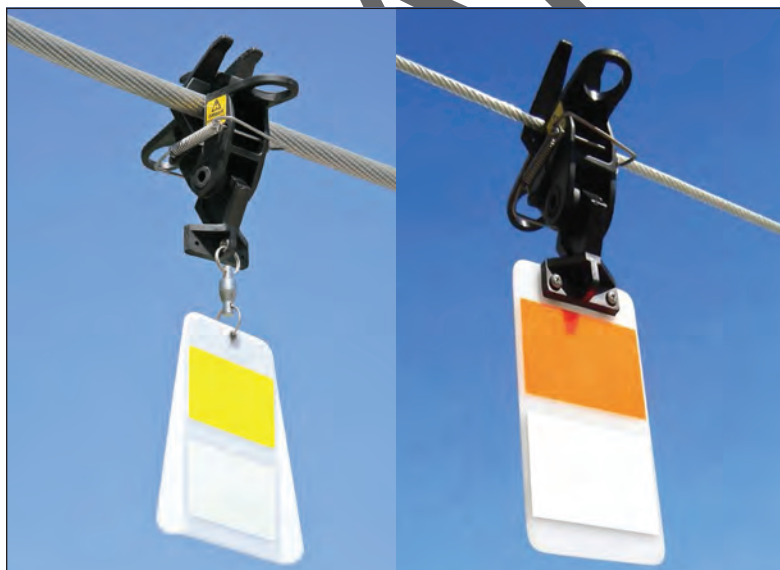


FIGURE 6.16: The FireFly™ FF (left) has a swinging tag for use in light winds and the FireFly™ HW (right) has a fixed tag to withstand higher, sustained winds.

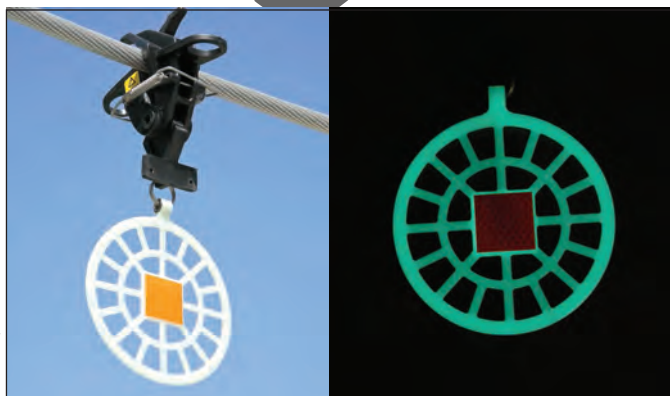
TABLE 6.13: Spacing and positioning for FireFlies.*

Device	Utility Industry Practices	Manufacturer Recommendations	Spacing Lengths Used in Experimental Studies [†]
FireFly™	15.2 m (50 ft) spacing, staggered on alternating wires (PacifiCorp)	Recommendations depend on the tower height: 4.6 m (15 ft) apart for towers less than 30.5 m (100 ft) and 9.1 m (30 ft) apart for towers that are greater than 30.5 m (100 ft) tall (Birdbusters).	5 to 12 m (16.4 to 39.3 ft) apart. Some studies staggered devices on parallel lines to either increase visual density or distribute loading equally.

* Actual spacing depends on engineering requirements, manufacturer specifications, species involved, and site-specific conditions.
[†] See Table 6.14 for study details and sources.

TABLE 6.14: Representative studies for FireFlies.

Description/Spacing	Location/Species	Power Line Characteristics	Effectiveness		Reference
			Behavioral Avoidance	Reduction in Collisions	
FireFly™, 9 cm × 15 cm (3.5 in × 6 in), 3 mm (0.13 in) thick, luminescent strip, spinning swivel, contrasting reflective colors on opposite sides/spacing: 5 m (16.4 ft); staggered on conductors	California/sandhill crane, song birds, other species	Distribution, 12 kV	No changes in flight height or reaction distance	60% reduction in collision frequency on marked lines, collision frequency also decreased on adjacent spans	Yee 2008
FireFly™, acrylic plastic tag measures 9 cm × 15 cm (3.5 in × 6 in), 3 mm (0.13 in) thick, yellow and orange reflective tape and photo-reactive coatings/spacing: 12-m (39.3-ft) intervals	Nebraska/sandhill cranes	Transmission, 69 kV	Cranes reacted more quickly (mainly by gradually gaining altitude) to avoid the marked line than they did to unmarked lines	Reduced collisions by half	Murphy et al. 2009

**FIGURE 6.17: BirdMark BM-AG (After Glow) in daylight (left) and darkness (right).**

© P&R TECHNOLOGIES, INC.

BirdMark BM-AG (After Glow)

The BirdMark BM-AG (After Glow) has a perforated swinging disk that spins and flutters (Figure 6.17). This device is 29.21 cm (11.5 in) long with a 13.33 cm (5.25 in) diameter disk with a reflective center. The BirdMark BM-AG is designed with a strong spring-loaded clamp that attaches to wires up to a diameter of 6.4 cm (2.5 in). The reflective disks glow for up to 10 hours after sunset and are available in orange, white, and red.

The manufacturer recommends 4.6 m (15 ft) spacing (Table 6.15). The movement of the device adds to the visibility of the line.

TABLE 6.15: Spacing and positioning for BirdMark BM-AG.*

Device	Utility Industry Practices	Manufacturer Recommendations	Spacing Lengths Used in Experimental Studies
BirdMark BM-AG	–	4.6 m (15 ft) (P&R Technologies)	No scientific studies on the BirdMark BM-AG were found.

* Actual spacing depends on engineering requirements, manufacturer specifications, species involved, and site-specific conditions.

Considerations for Suspended Devices

- In some of the earlier versions, there were problems with the device shifting (van Rooyen 2000).
- Depending upon the location, suspended devices can be targets for irresponsible shooters.
- The devices can be installed and removed from the ground or bucket truck with a hot stick. Two people are required for installation unless a special tool is used; homemade tools have worked better than some manufactured tools (S. Liguori, pers. comm.). New manufactured tools are being made and tested.
- Corona effects can occur depending upon the voltage (see *Corona Effects*, page 84).
- Installation cost increases with line height and in areas that are difficult to access such as river and lake crossings.
- Swivels have failed prematurely in high wind locations.

DEVICES AVAILABLE IN OTHER COUNTRIES

The following devices are not distributed in the United States at this time (2012).

Baliza Avifauna

The Baliza Avifauna is manufactured in Spain by Saprem. It is a variation of hanging strips that consists of two black neoprene crossed bands (measuring 6 cm × 28 cm [2.4 in × 11 in]). Some versions have a phosphorescent stripe.

Janss and Ferrer (1998) describe a similar device (with crossed bands measuring 5 cm × 35 cm [1.9 in × 13.8 in]) that was staggered on the conductors every 24 m (78.7 ft) (a visual effect of 12 m [39.3 ft] intervals). The device consisted of two black neoprene crossed bands slightly shorter than the com-



FIGURE 6.18: Hanging strips of neoprene, such as this Spanish-made Baliza Avifauna, are being used as line marking devices in Europe and South Africa.

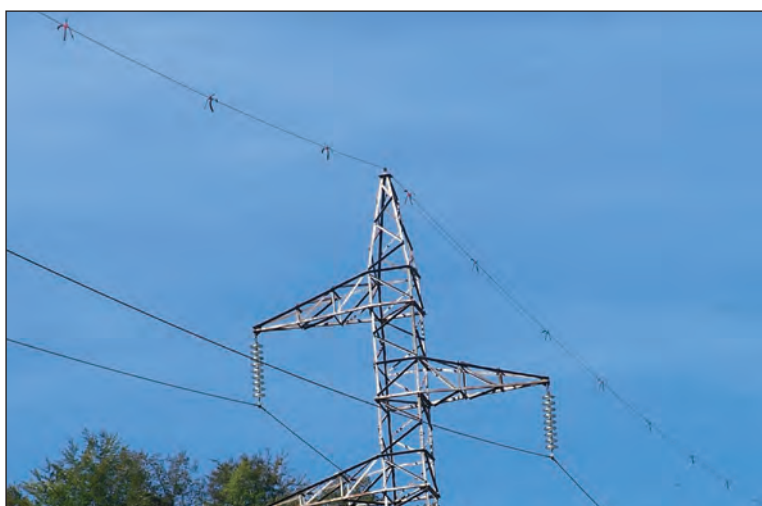


FIGURE 6.19: Baliza Avifauna installed on a power line in Europe.



© ETIENNE FOLLET/IRTE

FIGURE 6.20: The Avifaune Spiral is commonly used in France and other parts of Europe.

mercially available strips. Janss and Ferrer (1998) found the device reduced collisions by 76% on transmission (380 kV and 132 kV) and distribution (13 kV) lines. The device pictured here is widely used in Europe and South Africa.

Avifaune Spiral

The Avifaune Spiral is used in France and other parts of Europe. These are preformed PVC similar to the SFDs described previously. Avifaune Spirals are 91 cm (36 in) long and have two 36-cm (14-in) spirals in the middle. They are produced in two UV light protected colors: red and white. French researchers recommend alternating the colors. Raavel and Tombal (1991) indicate that the color combination is effective in variable light conditions on transmission lines. Avifaune Spirals have been used on phase conductors and shield wires with a recommended spacing of 7 to 10 m (23 to 32.8 ft).

Mace Bird Lite

The Mace Bird Lite is a spiral vibration damper with a fluorescent light attached inside a plastic tube. The light is energized by a phase conductor's electrical field and can be seen at night. These were designed specifically for 132-kV lines, but it should be possible to use them with other voltages. Although no precise scientific data are available on its effectiveness, this technology has been successfully used in Botswana and South Africa (Eskom 2003) in reducing flamingo collisions (Eskom Transmission 2009). The potential issue of the light attracting birds to a line was not addressed.

RIBE Bird Flight Diverter Fittings

RIBE bird flight diverter fittings are available in two versions: a swinging rectangular tag and a series of 10 alternating black-and-white, rigid plastic pieces that swing on a rod attached at both ends to a shield wire or phase conductor.



© DR/IRTE

FIGURE 6.21: Avifaune Spirals installed.



© MACE TECHNOLOGIES

FIGURE 6.22: The Mace Bird Lite is a spiral device with a central fluorescent tube that is illuminated by the ambient electrical field.



FIGURE 6.23: The RIBE line marking device is available as a swinging triangular tag or as a series of black-and-white, rigid plastic pieces that swing (pictured).

© RIBE

According to the manufacturer, results from a three-year field trial on the Bernbrug-Susigke 110-kV line in South Africa showed that these are effective at reducing bird collisions with power lines when compared to lines without diverters. The information suggests that closer spacing (20 m versus 40 m [65.6 ft versus 131.2 ft] apart) is more effective. However no description of the study design nor specific data was provided.

Inotec BFD 88

The Inotec BFD 88 is a relatively new device with characteristics of both suspended devices and spheres. It is a reflective stainless steel sphere, 7 cm (2.8 in) in diameter, attached to a metal spiral, which is attached to the wire. When installed they appear as small metal spheres suspended from the wire.

This device is made of 316-grade stainless steel and is naturally reflective and corrosion resistant. The crimp is made from marine-grade aluminum, a highly durable adhesive, and conductive rubber. According to the



FIGURE 6.24: The Inotec BFD 88, a South African device, is a reflective stainless steel sphere reported to be visible from all angles and in low-light conditions.

© INOTEC

manufacturer, the clamp does not come into contact with the phase conductor, so there is no chance of galvanic cell reaction or mechanical damage to the power line. The stainless steel sphere does not sway and cannot touch the power line.

Eskom Transmission (2009) indicates that these metal spheres are visibly superior to colored (red, yellow, white, or black) objects in low light, especially at dawn and dusk when birds are flying between roosting and feeding areas. The spherical shape reflects available light and is claimed to be visible from all directions including above or below the diverter. When viewed during low-light conditions, the device is visible against dark backgrounds such as the ground, trees, or high ground. It is also visible against bright clouds when viewed from below (Eskom Transmission 2009).

The diverter can be attached while a line is energized and installed from the ground with a hot stick. Because of the spherical design, it does not display corona. It was developed in South Africa for use on shield wires and phase conductors up to 88 kV, and no radio interference was detected up to 88 kV.

PLASTIC TUBES

Archibald (1987) reported that yellow plastic tubes placed on power lines near Hokkaido, Japan, in 1982 reduced mortality

of red-crowned cranes (*Grus japonensis*). Plastic tubes along with various versions of ribbons, however, are not durable enough for use.

LARGE DIAMETER WIRE

OVERSIZED SHIELD WIRE FOR TRANSMISSION LINES

A limited study compared the use of an oversized shield wire with a conventional shield wire (Brown et al. 1987; Miller 1990). The oversized wire was 2.52 cm (1 in) in diameter, or 2.6 times greater than standard shield wire (0.95 cm [0.4 in]). Researchers found that there was no significant difference between these wires. Other studies have identified the conventional, small-diameter shield wire as the highest risk wire for collisions with transmission lines (e.g., Savereno et al. 1996), which suggests that diameter and distance visibility are factors involved in collision risk. The use of larger-diameter shield wire is considerably more expensive. Though anecdotal reports suggest larger diameter shield wire is

effective, studies of its effectiveness are needed before it can be recommended for reducing collision risk.

TREE WIRE TO PREVENT COLLISION-ELECTROCUTIONS ON DISTRIBUTION LINES

Tree wire is a type of insulated phase conductor used on distribution lines to provide protection from momentary contact with tree branches, which would otherwise cause an electric arc (Figure 6.25, Figure 6.26, and Figure 6.27). The insulation is also sufficient¹⁷ to protect birds from collision-electrocutions, which are caused by phase-to-phase contact when large birds, such as eagles and swans, brush phase conductors while flying between them. The electric arc created in collision-electrocutions can kill multiple birds in a flock, even if only one bird makes phase-to-phase contact. Because tree wire can prevent collision-electrocutions, it has even been used in some open areas for rebuilt and new distribution lines (M. Walters, pers. comm.).

Tree wire may also be an effective means of reducing collision incidence because the insulated covering increases the diameter of the wire, making the line more visible. However, no scientific studies were found to verify this.

Retrofitting a line with tree wire is usually only a consideration when outages are caused by tree branches. It would be unusual to retrofit an existing line with tree wire to prevent collisions because line marking devices are more cost effective. However, when a distribution line is being upgraded or a new line is being built, tree wire may be a cost-effective option when used for the center

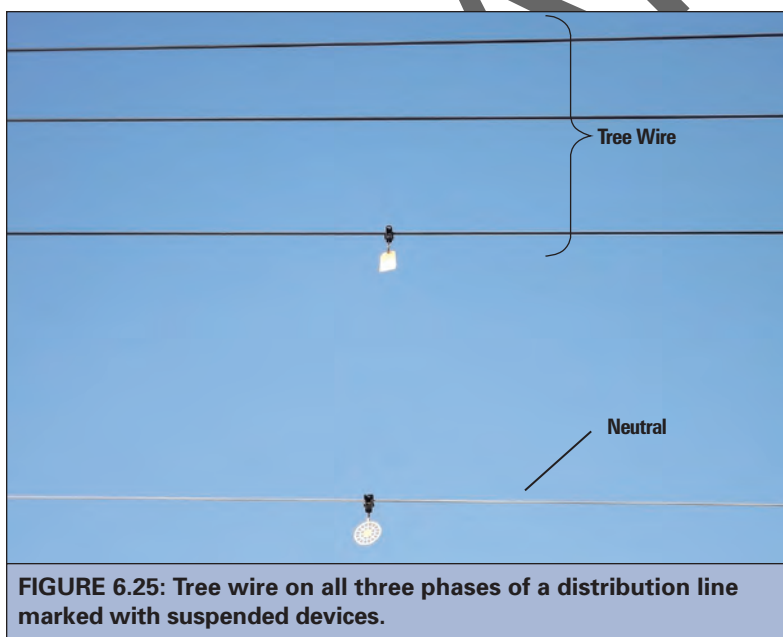
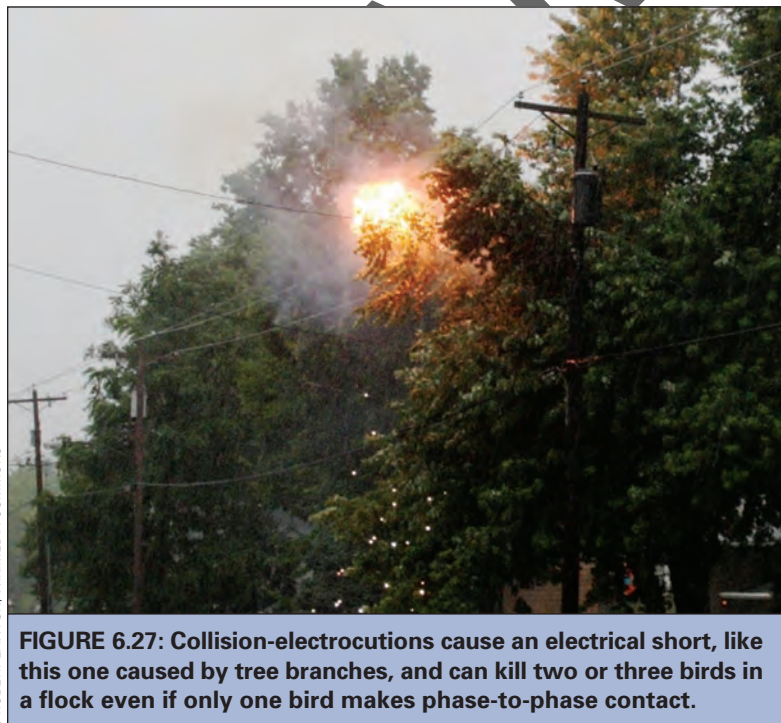
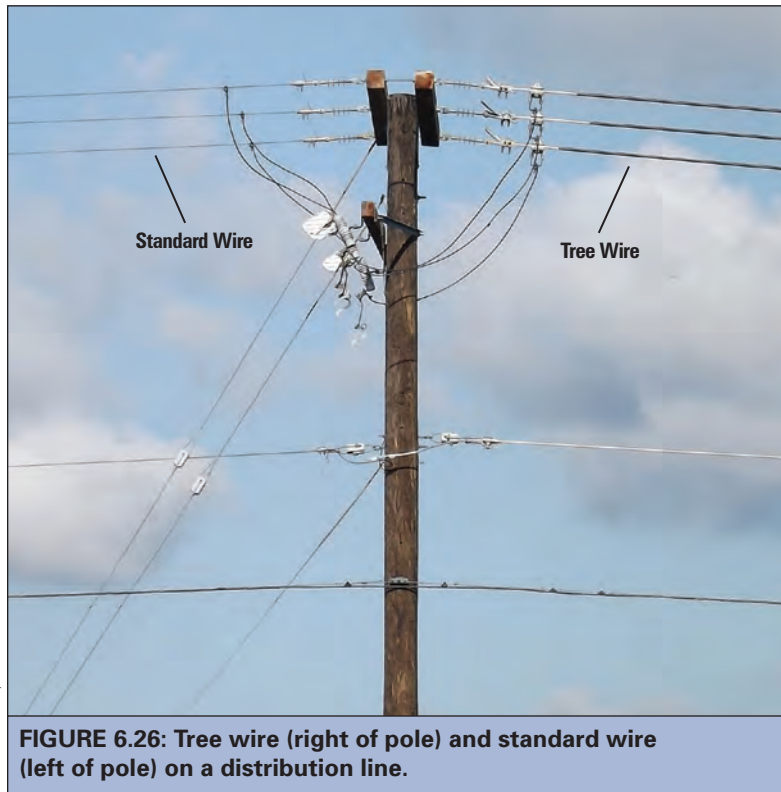


FIGURE 6.25: Tree wire on all three phases of a distribution line marked with suspended devices.

¹⁷ The insulation on tree wire is not considered protective for human safety.



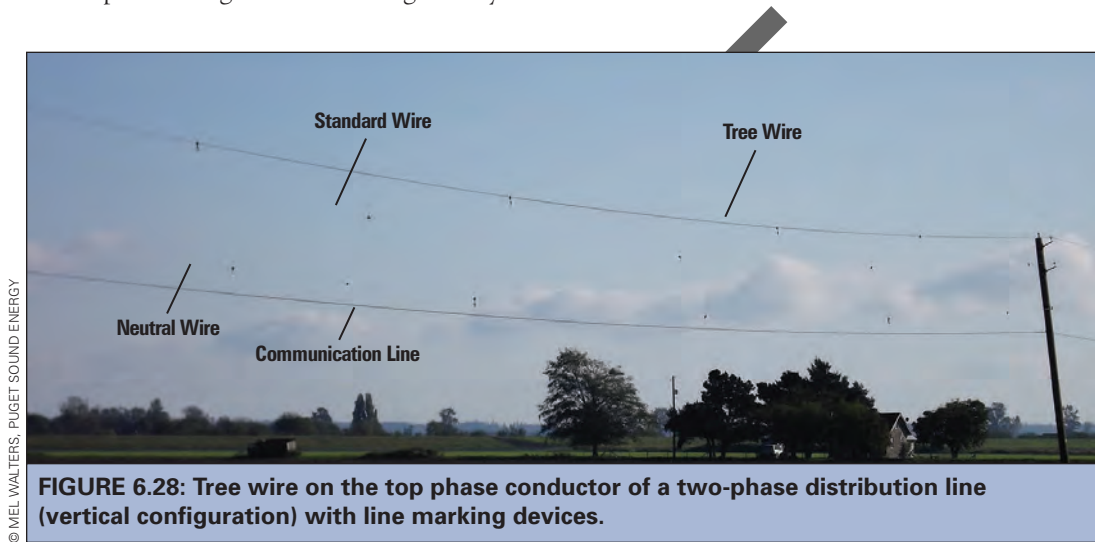
phase. The difference in cost (2011 \$) between tree wire (336ACSR TW = \$0.89 per 30.5 cm [12 in]) and standard wire (397KCM = \$0.77 per 30.5 cm [12 in]) is approximately \$0.12 per 30.5 cm (12 in) or \$1,900 per 1.6 km (1 mi) for a standard three-phase distribution feeder. Tree wire is also heavier than standard wire and may require higher class poles, more poles (1 to 2 per 1.6 km [1 mi]), and possibly additional guying. The average lifespan of tree wire is 40 years. The advantages to tree wire are that it reduces the risk of collision-electrocution at mid-span for flying birds, reduces the risk of electrocution for perching birds, and reduces the maintenance requirements usually associated with suspended devices.

Unpublished observations show that tree wire used in conjunction with line marking devices, such as the FireFly™ and/or Bird-Mark BM-AG, is effective at reducing collision-electrocutions and collisions for trumpeter swans (*Cygnus buccinator*), waterfowl, and raptors (M. Walters, pers. comm.). When rebuilding lines already equipped with flight diverters, the diverters are reinstalled on the new tree wire lines. The increased visibility of tree wire reduces the risk, which is further reduced by installing FireFlies (M. Walters, pers. comm.).

In the Chimacum Valley, Washington, from 2000 to 2007, an eight-span lateral line averaged three bird-caused outages per year due to swan and waterfowl collisions, including 10 swan mortalities in 2006 alone. In 2007, the line was modified with tree wire to prevent collision-electrocutions and with FireFlies to reduce collision risk. No swan mortalities or outages have occurred since the line was modified in spite of increasing swan populations and their continued use of this flight corridor. The landowner reported that the swan flight path is much higher over the lines since these modifications were made (M. Walters, pers. comm.).

At another site in western Washington's Skagit Valley, five swan mortalities occurred on a single-phase line in the winter of 2008–2009, and others had been documented in previous years. The line was rebuilt in a three-phase configuration during the summer of 2009, which included tree wire on the center phase along with alternating FireFly™

and BirdMark BM-AG devices on all three phase conductors. In the following winter season, no mortalities or outages occurred, although swan populations continue to increase. Between 1,000 and 2,000 swans forage in this area throughout the winter (M. Walters, pers. comm.).





CHAPTER 7

Avian Protection Plans

IN THIS CHAPTER

- Overview of Avian Protection Plans
- Components of an Avian Protection Plan
- Creating and Implementing an Avian Protection Plan

An Avian Protection Plan is a voluntary, utility-specific plan that provides a framework for reducing bird mortalities, documenting utility actions, and improving service reliability. In 2005, the U.S. Fish and Wildlife Service and the Avian Power Line Interaction Committee jointly published Avian Protection Plan Guidelines to provide utilities with resources and guidance for developing Avian Protection Plans. This chapter is based on those guidelines.

OVERVIEW OF AVIAN PROTECTION PLANS

An Avian Protection Plan (APP) is a utility-specific program for reducing the operational and avian risks that result from avian interactions with electric utility facilities. In 2005, the Avian Power Line Interaction Committee (APLIC) and the U.S. Fish and Wildlife Service (USFWS) announced their jointly developed Avian Protection Plan Guidelines (*Guidelines*) that are intended to help utilities manage their avian/power line issues. The *Guidelines* offer resources for developing APPs and provide a toolbox from which utilities may select and tailor APP components to fit their needs. An APP should provide the framework necessary for developing a program to reduce bird mortalities, document utility actions, and improve service reliability. The APP components are summarized in this section. The complete version of the *Guidelines* can be obtained from either the APLIC (www.aplic.org) or USFWS (www.fws.gov) websites.

An APP represents a utility's commitment to reducing its avian impacts. Since they are created by a utility, APPs are more easily modified to address newly developing or unforeseen problems. Despite the fact that APPs are generally initiated by utilities, a cooperative dialog between the utility and the USFWS is encouraged during development and implementation. This sets the tenor for those conversations that will inevitably follow as the APP is implemented and refined over time.

Implementing the *Guidelines* will reduce avian collision and electrocution risks. An APP represents responsible environmental practices to all stakeholders, and a utility that creates an APP to address its specific avian issues can benefit through regulatory compliance, reliability improvements, potential long-term cost savings, and positive recognition from regulators, employees, and customers.

COMPONENTS OF AN AVIAN PROTECTION PLAN

Although each utility's APP will be different, the overall goal of reducing avian mortality is the same. The *Guidelines* provide a framework along with principles and examples to help a utility craft an APP to best fit its needs. Because of utility-specific circumstances, some of the *Guidelines'* elements may not be applicable. The *Guidelines* present a comprehensive overview of the elements that should be considered in an APP. The APP should also be a "living document" that is modified over time to improve its effectiveness. Some or all of the following elements may be implemented:

- Corporate policy
- Training
- Permit compliance
- Construction design standards

- Nest management
- Avian reporting system
- Risk assessment methodology
- Mortality reduction measures
- Avian enhancement options
- Quality control
- Public awareness
- Key resources

Details on the nature of these elements and how they may be developed by a utility are discussed on the following pages.

CORPORATE POLICY

An APP usually includes a statement that balances the company's commitment to minimizing its impact on migratory birds, complying with bird-protection regulations, and providing reliable, cost-effective electrical service. To do this, it will comply with all necessary permits, monitor avian mortality incidents, and make reasonable efforts to construct and alter infrastructure to reduce the incidence of avian mortality.

TRAINING

Training is an integral component of an APP. Workshops and short courses on avian/power line interactions are provided by APLIC (www.aplic.org) and Edison Electric Institute (EEI) (www.eei.org). A two-hour overview of avian electrocutions and collisions intended for training use is also available to APLIC members through the APLIC website as part of the APP toolbox. Each company will have its own approach to training. All appropriate utility personnel, including managers, supervisors, line crews, engineering, dispatch, design personnel, and vegetation management personnel should be trained in avian issues. This training should encompass the reasons, needs, and methods for reporting avian mortalities, following nest management protocols, disposing of carcasses, complying with applicable



FIGURE 7.1: Utility employee training should include the reasons and methods for reporting bird mortalities, nest management protocols, proper disposal of carcasses, applicable regulations, and the consequences of non-compliance.

regulations, and understanding the potential consequences of non-compliance. Supplemental training also may be appropriate when there are changes in regulations, personnel, permit conditions, construction standards, bird protection materials, or internal policies.

PERMIT COMPLIANCE

Each utility developing an APP should familiarize itself with the different avian regulations and permit types and should work with wildlife agencies to determine whether permits are required for operational activities that may affect protected avian species (see [Chapter 3](#)). An APP should discuss how this is done and identify company permits. Particular attention should be given to activities that may require special purpose or related permits, including but not limited to nest relocation, temporary possession, depredation, salvage or disposal, scientific collection, and miscellaneous. State permits may also be required to manage protected bird nests or for temporary possession of nests, birds, or their parts.

CONSTRUCTION DESIGN STANDARDS

To improve system reliability, avian interactions should be considered when siting and designing new facilities and when operating and maintaining existing facilities. For those reasons the accepted standards for both new construction and retrofitting for risk minimization should be included in an APP. Companies can either rely upon the recommendations in APLIC documents for electrocutions and collisions or develop their own standards that meet or exceed these guidelines.

An APP may indicate that all new or rebuilt lines in identified avian-use areas or potential problem areas be built to current standards for minimizing electrocutions and collisions. Employing avian-safe construction standards in such areas will reduce future

legal and public relations problems and will enhance service reliability.

NEST MANAGEMENT

An APP may include procedures for managing nests on utility structures and in power line rights-of-way (ROW). This could include procedures for handling problem nests (ones that need to be relocated or removed) as well as for creating safe nest sites. These procedures should be explained to company employees during training to ensure uniform treatment of avian nest issues and compliance with regulations or permits related to nest management. For more detailed guidance regarding nest management, see *Suggested Practices for Avian Protection on Power Lines* (APLIC 2006).

AVIAN REPORTING SYSTEM

An avian reporting system is used for documenting bird injuries, fatalities, and nest management activities. This system should be described in the APP and designed to meet the needs of the utility and applicable avian permit reporting requirements. The reporting system should be compatible with a utility's other data management and analysis programs so this information can be effectively collected and recorded. The system could be based on paper forms or may be an internal web-based program. The information collected should be used to help a utility conduct risk assessments of avian problem areas and high risk structures or lines. To protect birds and minimize outages, these data can be prioritized for corrective actions. Avian information collected by a utility should be maintained internally. Reporting is required as a condition of the USFWS permit for direct take of birds or their nests (see [Chapter 3](#)).

The USFWS Office of Law Enforcement also maintains a voluntary, internet-based Bird Fatality/Injury Reporting Program.¹⁸

¹⁸ The USFWS (2012) has been internally referring to this as the Bird Information and Mortality Reporting System. The title on the web page may assume this title as well (A. Manville pers. comm.).

This program provides a clearinghouse of useful information for the electric utility industry to mitigate the impacts of energy delivery systems on birds and to address specific bird/power line problems on an incident-specific basis (USFWS 2009b). This database was designed to collect information about bird collisions and electrocutions to help with preventing future bird/power line incidents. It is also intended for utilities to see which structures pose a greater risk than others and under what conditions they occur. Utilities can establish a password-protected account with this voluntary program, and privacy and confidentiality are protected including several exemptions from the Freedom of Information Act (FOIA). The data collected include the characteristics of the fatality or injury, location, configuration of the equipment, environmental conditions, etc. To date (2012), at least 33 electric utilities have been voluntarily reporting through this program.

RISK ASSESSMENT METHODOLOGY

A utility can cost-effectively reduce avian mortalities by focusing its efforts on the areas of greatest risk. Therefore, an APP should include a method for evaluating and prioritizing the risks that a company's operations pose to migratory birds. A risk assessment will often begin with a review of available data that address areas of high avian use, avian mortality, problem nests, established flyways, migration corridors, concentration and staging areas, other preferred habitats, prey populations, perch availability, effectiveness of existing procedures, remedial actions, and other factors that can increase avian interactions with utility facilities. The avian reporting system discussed in the previous section is an integral component of this risk assessment, as is the use of avian experts, birders, and biologists who can provide additional information on avian distribution. A risk assessment can be used to develop models that will enable a company to use biological and electrical design information to choose

an optimal route during corridor and ROW siting and to prioritize existing poles and lines most in need of modification. A risk assessment may also provide data about the various causes of avian mortality as well as the benefits birds receive from utility structures. For more discussion on avian risk assessment, see [Chapter 5](#).

MORTALITY REDUCTION MEASURES

As a part of an APP, a mortality reduction process is described. A utility can use the results of an avian risk assessment to focus its efforts on areas of concern, ensure that its responses are not out of proportion to the risks presented to protected birds, and determine whether avian mortality reduction plans need to be implemented.

Mortality reduction plans may use strategies that include preventive, reactive, and proactive measures that focus on issues, risks, and reliability commitments facing a utility. The following are examples of how this multi-faceted approach may be used.

- **Preventive:** Construct all new or rebuilt lines in high avian-use areas to avian-safe standards. Apply collision minimization measures for new construction in high risk areas. Ensure that the APP is in compliance with applicable laws, regulations, and permits.
- **Reactive:** Document bird mortalities and problem nests, conduct assessment of problems, and apply remedial measures where appropriate. Notify resource agencies in accordance with the utility's permits and policies.
- **Proactive:** Provide resources and training to improve employees' knowledge and awareness. Partner with organizations that conduct research on effects of bird interactions with power lines. Evaluate risks of existing lines in high avian-use areas and prioritize structures or lines for retrofitting or mitigation according to their risk level.

A successful APP and mortality reduction plan requires management support as well as the following:

- Assessment of facilities to identify risks
- Allocation of resources
- Standards for new or retrofit construction
- Budget for operation and maintenance and capital investment
- System for tracking remedial actions and associated costs
- Timely implementation of remedial measures
- Positive working relationships with agencies

An APP should be reviewed annually in the context of risk assessment and modified as appropriate, ideally with wildlife agency input.

AVIAN ENHANCEMENT OPTIONS

In addition to reducing avian mortality risk, an APP also may include descriptions of opportunities for a utility to enhance avian populations or habitat. These opportunities may include installing nest platforms, managing habitats to benefit migratory birds, or



FIGURE 7.2: An Avian Protection Plan may include opportunities to enhance avian populations or habitat with nesting structures, habitat restoration, or other projects.

© JERRY LIGUORI

working with agencies or organizations in these efforts. Where feasible, new ideas and methods for protecting migratory birds should be encouraged and explored.

There are also opportunities to collaborate with agencies or organizations and to educate the public about the company's APP and its partnerships. USFWS and state wildlife agencies, as well as other experts, can be consulted for recommendations on habitat enhancement projects. Nest box construction, maintenance, and monitoring can be done in conjunction with volunteers, such as Boy Scouts, Girl Scouts, and avian/wildlife conservation organizations.

QUALITY CONTROL

A quality control mechanism can and should be incorporated into an APP to evaluate the effectiveness of a company's avian protection procedures. Some examples of quality control include the following:

- Effectiveness of remedial actions in reducing avian mortality
- Effectiveness of avian protection devices as well as their ease of application and durability
- Mortality reporting procedures to ensure that discoveries of avian mortalities are properly documented
- Response to avian mortalities to ensure that appropriate and timely actions are taken
- Compliance with company policy to ensure that personnel are consistently following company procedures for avian-safe construction, mortality reporting, nest management, training, etc.
- Public and agency feedback and opinions on system reliability and avian protection

The quality control component of an APP is a continuous process that is used to ensure that a company's APP is accomplishing what

it is intended to do. Information gathered during assessments of existing practices should be used to improve the effectiveness and timeliness of avian protection efforts, which, in turn, can help to reduce costs associated with such efforts.



© PACIFIC GAS AND ELECTRIC COMPANY

PUBLIC AWARENESS

An APP may include a method for educating the public about avian collision issues, the company's avian protection program, and its successes in avian protection. A public awareness program can be an integral part of an APP and can be used to enhance public awareness and support for a company's APP. Public participation allows stakeholders such as government agencies, tribes, non-profit organizations, wildlife rehabilitators, and other interested parties an opportunity to provide input to the decision-making process, enabling all parties to work openly and collaboratively towards recommendations that can be effectively implemented. This collaboration often leads to improved relationships within the community and to more efficient and positive projects (see [Chapter 5](#)). The relationships developed through this process may also encourage the public to report bird mortalities and encourage them to seek assistance for birds that have been injured in power line-related accidents.

Communicating an APP can be accomplished through a variety of public outreach tools, including fact sheets, newsletters, brochures, videos, websites, public workshops, short courses, special training sessions, and speaker bureau presentations. These tools can also be used to record the success of an APP, thereby documenting the utility and electric industry's efforts to reduce avian mortalities. The goal of these outreach efforts is to convey to the public that electric utilities are responsible environmental stewards working cooperatively with wildlife agencies towards reducing avian mortalities while continuing to provide safe, reliable, and affordable electricity to their customers.

Many utilities have examples of their environmental stewardship and of the innovative ways they have reduced environmental impacts through their business decisions. A company's efforts to minimize avian mortalities should

be shared with the public and resource agencies. For more information, see *Public Participation* in Chapter 5.

KEY RESOURCES

An APP should identify the key resources that address avian protection issues. Key resources include utility personnel and external contacts. This would include a list of experts who may be called upon to help resolve avian-caused problems. Experts could include company specialists, consultants, state and federal resource agents, university faculty, or other biologists. Internal personnel may include representatives from environmental, engineering, operations and maintenance, standards, procurement, outage management, etc. Engineers may find that company personnel such as environmental specialists (or biologists) can help find creative solutions to

avian interaction problems. An understanding of avian behavior can also influence how and when avian protection should be provided. An APP that connects biologists with utility decision-makers may reduce bird mortality and improve system reliability.

Members of organizations like APLIC can help with workshops, materials, and contacts. External resources may include biologists and law enforcement agents from wildlife agencies, avian specialists from NGOs or universities, wildlife rehabilitators, and industry consultants. Utility industry resources include APLIC, EEI, Electric Power Research Institute, Institute of Electrical and Electronics Engineers, National Rural Electric Cooperative Association, and the Rural Utilities Service. Contact information and websites for a number of resources are available in the *Guidelines* (see www.aplic.org).

CREATING AND IMPLEMENTING AN AVIAN PROTECTION PLAN

Integrating an APP into an electric utility's operations will help the utility meet demands for reliable, cost-efficient, and environmentally compatible power delivery. A utility that creates and manages an APP will quickly become familiar with the avian-related science, engineering, and laws. It will also need to satisfy utility employees, utility customers, investors, and other stakeholders.

The ease of creating and implementing an APP will depend on a utility's size, the location of its transmission and distribution system, the range of avian species in the service area, and the frequency of bird/power line interactions. The extent of bird/power line interactions may not be realized until several years into a fully implemented reporting program. Thus, APP implementation and operation is a long-term commitment and a process of continual evaluation and improvement.

Depending on the company's culture, the rate of adoption may vary. An APP may be the first species-oriented environmental com-

pliance initiative to which utility employees are exposed. High-profile endorsements by corporate officers and managers can facilitate a program's implementation. Some larger utilities have effectively linked APP compliance with financial incentives, similar to more common budget, schedule, and safety incentives. Compliance with an APP will reduce utility costs in the long term through improved reliability and reduced regulatory risk.

Creating and implementing an APP will be more successful if all the affected departments within the utility also support it. An effective way to build a broad consensus during APP preparation is to form a team within the utility that includes representatives from standards, engineering, environmental services, vegetation management, construction, operations and maintenance, public relations, customer service, and other departments that will be impacted by the APP. Considerable input and assistance from team members are needed to understand how APP implementation will



FIGURE 7.4: Integrating an Avian Protection Plan into an electric utility's operations will help the utility meet demands for reliable, cost-efficient, and environmentally compatible power delivery while protecting and enhancing bird populations.

© USFWS

best fit the operations of each department. Solutions to reduce avian mortality can be developed that are responsive to the work requirements of each functional unit. In this manner, individuals from each department will feel invested in the mortality reduction solutions they helped develop and will have an interest in assuring APP effectiveness.

Beyond developing and communicating a corporate APP policy, the most important

component of an APP is a consistent and mandatory reporting process. An electronic or paper form of documenting bird/power line conflicts (e.g., time, place, equipment) becomes the foundation for appropriate corrective action—both to correct unsafe situations and to build a dataset to guide future engineering/construction needs. Managing data for these purposes, as well as for meeting any state and federal agency reporting requirements, is an important function of APP administration. Using GIS technology to track and report bird mortalities, remedial actions, outages, and avian risks enables a utility to identify problems and to track the effectiveness of its APP.

Use of existing processes and systems (e.g., outage reporting, environmental review, asset management, and accounting) will help control costs of developing and implementing an APP. Whether an APP is driven by an environmental, engineering, or operations department, cooperation will be necessary across all departments to reduce actual and potential avian/power line conflicts. As with any project, better planning yields better results. The goals of an APP are a measurable decrease in avian/power line injuries and mortalities and an increase in electric service reliability—ultimately benefiting the birds, the utility, its customers, the regulators, and the affected public.



APPENDIX A

Literature Cited
and Bibliography

- * Abdunazarov, B. B. 1987. Prevention of death of birds at power supply lines in Uzbekistan. Information message No. 411. Tashkent, Fan. Page II.
- * Alonso, J. C., J. A. Alonso, and R. Muñoz-Pulido. 1994. Mitigation of bird collisions with transmission lines through groundwire marking. *Biol. Conserv.* 67:129–134.
- * Alonso, J. A., and J. C. Alonso. 1999. Mitigation of bird collisions with transmission lines through groundwire marking. Chapter 5 in M. Ferrer and G. F. E. Janns (eds.), *Birds and Power Lines*. Quercus: Madrid.
- * _____, and C. A. Martin. 2005. The great bustard (*Otis tarda*) in Andalusia, southern Spain: status, distribution, and trends. *Ardeola* 52(1):67–78
- Anderson, B. A., and S. M. Murphy. 1988. Lisburne terrestrial monitoring program—1986 and 1987. The effects of the Lisburne power line on birds. Final Report. Prepared by Alaska Biological Research, Inc. for ARCO Alaska, Inc., Anchorage, AK 99510. 60 pp.
- * Anderson, M. D. 2001. The effectiveness of two different marking devices to reduce large terrestrial bird collisions with overhead electricity cables in the eastern Karoo, South Africa. Draft Report to Eskom Resources and Strategy Division, Johannesburg, South Africa.
- Anderson, S. H., K. Mann, and H. H. Shugart, Jr. 1977. The effect of transmission-line corridors on bird populations. *Am. Midl. Nat.* 97:216–221.
- * Anderson, W. L. 1978. Waterfowl collisions with power lines at a coal-fired power plant. *Wildlife Soc. B.* 6:77–83.
- _____, and S. S. Hurley. 1974. Waterfowl studies at Lake Sangchris: an in-progress report. Illinois Natural History Survey, Urbana.
- _____, _____, and J. W. Seets. 1975. Section 8 waterfowl studies at Lake Sangchris. Illinois Natural History Survey, Urbana.

* Indicates references that have been cited in the text.

- * Archibald, K. 1987. The conservation status of the breeding ground of the red-crowned crane in Hokkaido, Japan. Pages 64–86 in G. Archibald and R. Pasquier (eds.), Proc. International Crane Workshop, Bharatpur, India, 1983. Intl. Crane Foundation, Baraboo, WI.
- Arnett, E. B. 2006. A preliminary evaluation on the use of dogs to recover bat fatalities at wind energy facilities. *Wildlife Soc. B.* 34:1440–1445.
- Avatar Environmental, LLC, EDM International, Inc., and Pandion Systems, Inc. 2004. Notice of inquiry comment review avian/communication tower collisions, final. Prepared for the Federal Communications Commission. 223 pp.
- * Avery, M. L. (ed.). 1978. Impacts of transmission lines on birds in flight: Proceedings of a workshop. U.S. Fish and Wildlife Service, Biological Services Program, FWS/OBS-78/48. 151 pp.
- _____, and T. Clement. 1972. Bird mortality at four towers in eastern North Dakota: fall 1972. *The Prairie Naturalist* 4:87–95.
- _____, P. F. Springer, and J. F. Cassell. 1975. Progress report on bird losses at the Omega Tower, southeastern North Dakota. Proc. North Dakota Academy of Science, Part II 27:40–49.
- * _____, _____, and _____. 1977. Weather influences on nocturnal bird mortality at a North Dakota tower. *Wilson Bull.* 89:291–299.
- * _____, _____, and N. S. Dailey. 1980. Avian mortality at man-made structures: an annotated bibliography (revised). U.S. Fish and Wildlife Service, Biological Services Program, National Power Plant Team. FWS/OBS-80/54, 152 pp.
- * Avian Power Line Interaction Committee (APLIC). 1994. Mitigating bird collisions with power lines: the state of the art in 1994. Edison Electric Institute, Washington, D.C. 78 pp.
- * _____. 2006. Suggested practices for avian protection on power lines: the state of the art in 2006. Edison Electric Institute, APLIC, and the California Energy Commission, Washington, D.C., and Sacramento, CA.
- * _____. 2007. Causes of avian collisions with power lines and methods for collision reduction. In APLIC Avian Protection Short Course/Workshop, Collisions Section.
- _____. 2008. Avian interactions with power lines: an overview of avian protection plan guidelines, laws, and techniques for the protection of avian species. Two-hour short course.
- * _____ and U.S. Fish and Wildlife Service (USFWS). 2005. Avian protection plan (APP) guidelines. Washington, D.C. 88 pp.
- Bahat, O. 2008. Wintering black storks (*Ciconia nigra*) cause severe damage to transmission lines in Israel: a study on the risk and mitigation possibilities. In Proc. of the EDM and EPRI Internat. Conf. on Overhead Lines. 31 March–3 April 2008. Fort Collins, CO.
- Baines, D., and R. W. Summers. 1997. Assessment of bird collisions with deer fences in Scottish forests. *J. Appl. Ecol.* 34:941–948.
- * Banko, W. E. 1956. The trumpeter swan: its history, habits, and population in the United States. *N. Amer. Fauna* 63:325–326.

- *Barrett, G. C., and D. V. Weseloh. 2008. Bird mortality near high voltage transmission lines in Burlington and Hamilton, Ontario, Canada. Pages 421–428 in J. W. Goodrich-Mahoney, L. P. Abrahamson, J. L. Ballard, and S. M. Tikalsky (eds.), Proc. of the Eighth International Symposium on Environmental Concerns in Rights-of-Way Management. 12–16 September 2004, Saratoga Springs, NY. Elsevier, Amsterdam, The Netherlands.
- *Barrientos, R., J. C. Alonso, C. Ponce, and C. Palacín. 2011. Meta-analysis of the effectiveness of marked wire in reducing avian collisions with power lines. *Conserv. Biol.* 25:893–903
- *_____, C. Ponce, C. Palacín, C. A. Martín, B. Martín, and J. C. Alonso. 2012. Wire marking results in a small but significant reduction in avian mortality at power lines: A BACI designed study. *PLoS ONE* 7(3): e32569.
- Bart, J., K. P. Burnham, E. H. Dunn, C. M. Francis, and C. J. Ralph. 2004. Goals and strategies for estimating trends in landbird abundance. *J. Wildlife Manage.* 68:611–626.
- Bayle 1999. Preventing birds of prey problems at transmission lines in Western Europe. *J. Raptor Res.* 33:43–48.
- Beason, R. C. 2003. Through a bird's eye: exploring avian sensory perception. USDA Wildlife Services, National Wildlife Research Center, Sandusky, Ohio, Special Scientific Report.
- *Beaulaurier, D. L. 1981. Mitigation of bird collisions with transmission lines. Bonneville Power Admin., U.S. Department of Energy, Portland, OR. 82 pp.
- *Beer, K. V., and M. A. Ogilvie. 1972. Mortality. Pages 125–142 in Peter Scott and the Wildfowl Trust, the swans, Houghton Mifflin Co., Boston.
- *Bennett, A. T. D., and M. Thery. 2007. Avian color vision and coloration: multi-disciplinary evolutionary biology. *Am. Nat.* 169: S1–S6.
- Berger, R. P. 1995. Fur, feathers, and transmission lines: how rights of ways affect wildlife. Second edition. Manitoba Hydro. www.hydro.mb.ca/environment
- *Bevanger, K. 1994. Bird interactions with utility structures: collision and electrocution, causes and mitigating measures. *Ibis* 136:412–425.
- *_____. 1995. Estimates and population consequences of tetraonid mortality caused by collisions with high tension power lines in Norway. *J. Appl. Ecol.* 32:745–753.
- *_____. 1998. Biological and conservation aspects of bird mortality caused by electricity power lines: a review. *Biol. Conserv.* 86:67–76.
- *_____. 1999. Estimating bird mortality caused by collision and electrocution with power lines: a review of methodology. Pages 29–56 in M. Ferrer and G. F. E. Janss (eds.), *Birds and Power Lines: Collision, Electrocution, and Breeding*, Quercus, Madrid, Spain.
- _____, and H. Broseth. 2001. Bird collisions with power lines: an experiment with ptarmigan (*Lagopus* spp.). *Biol. Conserv.* 99:341–346.
- *_____, and _____. 2004. Impact of power lines on bird mortality in a subalpine area. *Animal Biodiversity and Cons.* 27:67–77.

- BioResource Consultants. 2009. Identifying electric distribution poles for priority retrofitting to reduce bird mortality. California Energy Commission, PIER Energy-Related Environmental Research. CEC-500-08-055.
- *BirdLife International. 2003. Protecting birds from power lines: a practical guide on the risks to birds from electricity transmission facilities and how to minimise any such adverse effects. 31 pp.
- *_____. 2007. Position statement on birds and power lines on the risks to birds from electricity transmission facilities and how to minimise any such adverse effects. 12 pp.
- Birkhead, M. E., and C. Perrins. 1986. *The Mute Swan*. Croom-Helm, London.
- Bishop, J. A., and W. L. Myers. 2004. Associations between avian functional guild response and regional landscape properties for conservation planning. *Ecol. Indic.* 5:33–48.
- *Black, B. B., and M. W. Collopy. 1982. Nocturnal activity of Great Blue Herons in a north Florida salt marsh. *J. Field Ornithol.* 53:403–406.
- Blackwell, B. F., and G. E. Bernhardt. 2004. Efficacy of aircraft landing lights in stimulating avoidance behavior in birds. *J. Wildlife Manage.* 68:725–732.
- _____, E. Fernandez-Juricic, T. W. Seamans, and T. Dolan. 2009. Avian visual system configuration and behavioural response to object approach. *Anim. Behav.* 77:673–684.
- *Blair, R. B. 1996. Land use and avian species diversity along an urban gradient. *Ecol. Appl.* 6:506–519.
- Blokpoel, H. 1971. A preliminary study on height and density of nocturnal fall migration. Canadian Wildlife Service Report Series, Number 14:95–104.
- *_____, and P. R. M. Hatch. 1976. Snow geese, disturbed by aircraft, crash into power lines. *Can. Field Nat.* 90:195.
- Boren, J. C., D. M. Engle, M. W. Palmer, R. E. Masters, and T. Criner. 1999. Land use change effects on breeding bird community composition. *J. Range Manage.* 52:420–430.
- Bourne, W. R. P. 1976. Petrels and lights at night. *Notornis* 23:201–202.
- *Boyd, H. 1961. Reported casualties to ringed ducks in the spring and summer. *Wildfowl Trust Ann. Rep.* 12:144–146.
- Bridges, J. M., and T. R. Anderson. 2002. Mitigating the impacts of electric facilities to birds. In J. W. Goodrich-Mahoney, D. Mutrie, and C. Guild (eds.), *Proc. of the Seventh International Symposium Environmental Concerns in Rights-of-Way Management*. 9–13 September 2000, Calgary, Alberta, Canada. Elsevier, Oxford, UK.
- _____, and R. Lopez. 1995. Reducing large bird electrocutions on a 12.5 kV distribution line originally designed to minimize electrocutions. Pages 263–265 in G. J. Doucet, C. Séguin, and M. Giguère (eds.), *Proc. of the Fifth International Symposium on Environmental Concerns in Rights-of-Way Management*. 19–22 September 1993, Montreal, Canada. Hydro-Quebec, Montreal, Canada.
- _____, and D. McConnon. 1981. Use of raptor nesting platforms in a central North Dakota high voltage transmission line. Pages 46–49 in W. R. Byrnes and H. A. Holt (eds.), *Proc. of the Fourth Symposium on Environmental Concerns in Rights-of-Way Management*. 25–28 October 1987, Indianapolis, IN. Purdue University, West Lafayette, IN.

- * _____, T. R. Anderson, D. Shulund, L. Spiegel, and T. Chervick. 2008. Minimizing bird collisions: what works for the birds and what works for the utility? Pages 331–335 in J. W. Goodrich-Mahoney, L. P. Abrahamson, J. L. Ballard, and S. M. Tikalsky (eds.), Proc. of the Eighth International Symposium on Environmental Concerns in Rights-of-Way Management. 12–16 September 2004, Saratoga Springs, NY. Elsevier, Amsterdam, The Netherlands.
- Brittain, C. C., and P. Jelen. 2006. Bird on a wire: an elevated state. Arizona Public Service. Unpubl. rep. Prescott, AZ. 6 pp.
- * Brown, W. M. 1993. Avian collisions with utility structures: biological perspectives. *In Proc. of the Intl. Workshop on Avian Interactions with Utility Structures*, 13–16 September 1992, Miami, Florida. Electric Power Research Institute and Avian Power Line Interaction Committee, Palo Alto, CA.
- * _____ and R. C. Drewien. 1995. Evaluation of two power line markers to reduce crane and waterfowl collision mortality. *Wildlife Soc. B.* 23:217–227.
- * _____, _____, and D. L. Walker. 1984. Crane flight behavior and mortality associated with power liners in the San Luis Valley, Colorado. Forest, Wildlife and Range Experiment Station, University of Idaho, Moscow, ID. 16 pp.
- * _____, _____, _____, and E. G. Bizeau. 1987. Mortality of cranes and waterfowl from power line collisions in the San Luis Valley, Colorado. Pages 128–136 in J. C. Lewis (ed.), Proc. 1985 Crane Workshop. Platte River Whooping Crane Maintenance Trust, Grand Island, NE.
- Brunetti, O. A. 1965. Supplementary report. Cause of death of the Pinehurst condor. California Dept. Fish and Game, Unpubl. rep.
- * Bumby, S., K. Druzhinina, R. Feraldi, and D. Werthmann. 2009. Life cycle assessment (LCA) of overhead versus underground primary power distribution systems in Southern California. Donald Bren School of Environmental Science and Management, University of California, Santa Barbara, CA. 125 pp.
- Buffington, J. P. 1976. A synthetic definition of biological significance. Pages 319–327 in Proc. of the Workshop on the Biological Significance of Environmental Impacts. U.S. Nuclear Reg. Comm., Washington, D.C.
- Burnham, J., R. Carlton, E. A. Cherney, G. Couret, K. T. Eldridge, M. Farzaneh, S. D. Frazier, R. S. Gorur, R. Harness, D. Shaffner, S. Siegel, and J. Varner. 2004. Preventive measures to reduce bird-related power outages—part I: electrocution and collision. *IEEE Transactions on Power Delivery* 19:1843–1847.
- Byrne, S. 1999. Avian Power Line Interaction Committee, consultant report. California Energy Commission, PIER Energy-Related Environmental Research. Contract no. 500-97-010, project no. 06, San Francisco, CA.
- _____. 2000. Bird strike monitor, consultant report. California Energy Commission, PIER Energy-Related Environmental Research. Contract no. 500-97-010, project no. 05, San Ramona, CA.
- * California Energy Commission (CEC). 2005. Guide to raptor remains. www.energy.ca.gov

- * _____. 2011. On-line annotated bibliography of avian interactions with utility structures. www.energy.ca.gov/research/environmental/avian_bibliography
- * California Wind Energy Association (CalWEA). 2011. Improving methods for estimating fatality of birds and bats at wind energy facilities in California. Public Interest Energy Research Program, Environmental Area, Contract Number: PIR-08-028.
- Casado, E., J. Balbontin, and M. Ferrer. 2002. Plasma chemistry in booted eagle (*Hieraetus pennatus*) during breeding season. *Comp. Biochem. Physiol., Part A: Molecular and Integrative Physiol.* 131:233–241.
- * Catron, J., R. Rodríguez-Estrella, R. C. Rogers, L. B. Rivera, and B. Granados. 2004. Raptor and raven electrocutions in northwestern Mexico: A preliminary regional assessment of the impact of concrete power poles. Report prepared for the Avian Power Line Interaction Committee.
- * Chace, J. F., and J. J. Walsh. 2006. Urban effects on native avifauna: a review. *Landscape Urban. Plan.* 74:46–69. Elsevier Science, Amsterdam, The Netherlands.
- Chalfoun, A. D., M. J. Ratnaswamy, and F. R. Thompson, III. 2002. Songbird nest predators in forest-pasture edge and forest interior in a fragmented landscape. *Ecol. Appl.* 12:858–867.
- Clarke, T. L. 2004. An autonomous bird deterrent system. Unpubl. dissertation. University of Southern Queensland, Australia. 110 pp.
- Cochran, W. W., and R. R. Graber. 1958. Attraction of nocturnal migrants by lights on a television tower. *Wilson Bull.* 70:378–380.
- Cohen, D. A. 1896. California department. *Osprey* 1:14–15.
- * Colorado Public Utility Commission. 1982 [January 21]. Decision No. R82-93. Public Service Company of Colorado, Clark-Jordan Road 230-kV Cable Project.
- * Colson, E. W., and E. H. Yeoman. 1978. Routing transmission lines through water bird habitat in California. Pages 87–90 in M. L. Avery (ed.), *Impacts of transmission lines on birds in flight*, FWS/OBS 778/48. U.S. Fish and Wildlife Service, Washington, D.C.
- * Committee on the Status of the Endangered Wildlife in Canada (COSEWIC). 2009. About COSEWIC. www.cosewic.gc.ca/eng/sct6/sct6_3_e.cfm#hist
- * Cooper, B. 2004. Radar studies of nocturnal migration at wind sites in the eastern U.S. *In Proc. of the Wind Energy and Birds/Bats Workshop: Understanding and Resolving Bird And Bat Impacts*. RESOLVE, Inc. Washington, D.C. 66–71pp.
- Cooper, B. A., and R. H. Day. 1992. Interaction of Newell's shearwaters and dark-rumped petrels with utility structures on Kauai, Hawaii: Results of pilot study, all 1992. Prepared for the Electric Power Research Institute, Palo Alto, CA. 51 pp.
- * _____, and _____. 1998. Summer behavior and mortality of dark-rumped petrels and Newell's shearwater at power lines on Kauai. *Col. Waterbird* 21:11–19.
- _____, _____, R. H. Ritchie, and C. L. Cranor. 1991. An improved marine radar system for studies of bird migration. *J. Field Ornithol.* 62:367–377.

Cornwell, G., and H. A. Hochbaum. 1971. Collisions with wires: a source of anatic mortality. *Wilson Bull.* 83:305–306.

* Coues, E. 1876. The destruction of birds by telegraph wire. *Am. Nat.* 10:734–736.

* Convention on Migratory Species (CMS). 2011a. Review of the conflict between migratory birds and electricity power grids in the African-Eurasian region. Prepared for the UNEP African-Eurasian Waterbirds Agreement and CMS. Prepared by Bureau Waardenburg, Boere Conservation Consultancy, STRIX Ambiente e Inovação, and Endangered Wildlife Trust—Wildlife & Energy Program.

* _____. 2011b. Guidelines for mitigating conflict between migratory birds and electricity power grids. First draft for consultation with the AEW Technical Committee and the CMS Scientific Council. Prepared by Bureau Waardenburg, Endangered Wildlife Trust—Wildlife & Energy Program, Boere Conservation Consultancy, and STRIX Ambiente e Inovação.

Cousquer, G. 2005. Ophthalmological findings in free-living tawny owls (*Strix aluco*) examined at a wildlife veterinary hospital. *Vet. Rec.* 156:734–739.

* Curtis, C. 1997. Birds and transmission lines. *Blue Jay* 55:43–47.

* Crawford, R. L., and R. T. Engstrom. 2001. Characteristics of avian mortality at a north Florida television tower: a 29-year study. *J. Field Ornithol.* 72(3):380–388.

Critchlow, R., K. Collins, R. Sharp, and D. Bradley. 2008. Use of methyl anthranilate fog to haze nuisance birds at high-voltage electric substation. *In Proc. of the EDM and EPRI Internatl. Conf. on Overhead Lines.* 31 March–3 April 2008. Fort Collins, CO.

* Crivelli, A. J., H. Jerrentrup, and T. Mitchev. 1988. Electric power lines: a cause of mortality in *Pelecanus crispus* Bruch, a world endangered species, in Porto-Lago, Greece. *Col. Waterbird* 11:301–305.

* Crowder, M. R. 2000. Assessment of devices designed to lower the incidence of avian power line strikes. Master's Thesis, Purdue University.

* _____. and O. E. Rhodes, Jr. 2002. Relationships between wing morphology and behavioral responses to unmarked power transmission lines. *In J. W. Goodrich-Mahoney, D. Mutrie, and C. Guild (eds.), Proc. of the Seventh International Symposium Environmental Concerns in Rights-of-Way Management.* 9–13 September 2000, Calgary, Alberta, Canada. Elsevier, Oxford, UK.

* Day, R. H., B. A. Cooper, and T. C. Telfer. 2003. Decline of Townsend's (Newell's) shearwaters (*Puffinus auricularis newelli*) on Kauai, Hawaii. *Auk* 120:669–679.

De La Zerda, S., and L. Rosselli. 2002. Mitigating collision of birds against transmission lines in wetland areas in Colombia, by marking the ground wire with bird flight diverters (BFD). *In J. W. Goodrich-Mahoney, D. Mutrie, and C. Guild (eds.), Proc. of the Seventh International Symposium Environmental Concerns in Rights-of-Way Management.* 9–13 September 2000, Calgary, Alberta, Canada. Elsevier, Oxford, UK.

- *_____, and _____. 2003. Mitigación de colisión de aves contra líneas de transmisión eléctrica con marcaje del cable de guarda [Mitigation of collisions of birds with high-tension electric power lines by marking the ground wire]. *Ornitología Colombiana* 1:42–62.
- DeLong, J. P., S. W. Cox, and N. S. Cox. 2005. A comparison of avian use of high- and low-elevation sites during autumn migration in central New Mexico. *J. Field Ornithol.* 76:326–333.
- De Lucas, M., G. F. E. Janss, D. P. Whitfield, and M. Ferrer. 2008. Collision fatality of raptors in wind farms does not depend on raptor abundance. *J. Appl. Ecol.* 45:1695–1703.
- *Deng, J., and P. Frederick. 2001. Nocturnal flight behavior of waterbirds in close proximity to a transmission power line in the Florida Everglades. *Waterbirds* 24:419–424.
- Dieni, J. S., and S. L. Jones. 2002. A field test of the area search method for measuring breeding bird populations. *J. Field Ornithol.* 73:253–257.
- Dillingham, P. W., and D. Fletcher. 2008. Estimating the ability of birds to sustain additional human-caused mortalities using a simple decision rule and allometric relationships. *Biol. Conserv.* 141:1783–1792.
- *Dodd, S. L., and M. A. Colwell. 1998. Environmental correlates of diurnal and nocturnal foraging patterns of nonbreeding shorebirds. *Wilson Bull.* 110(2):182–189.
- *Dorin, M., and L. Spiegel. 2005. Assessment of avian mortality from collisions and electrocutions. California Energy Commission, Sacramento, CA. Technical Report CEC-700-2005-015.
- *Drewitt, A. L., and R. H. W. Langston. 2008. Collision effects of wind-power generators and other obstacles on birds. *Annals NY Acad. Sci.* 1134:233–266.
- Dunn, E. H. 1993. Bird mortality from striking residential windows in winter. *J. Field Ornithol.* 64:302–309.
- Dwyer, J. F. 2004. Investigating and mitigating raptor electrocutions in an urban environment. M.S. Thesis, Univ. of Arizona. 71 pp.
- *_____, and R. W. Mannan. 2007. Preventing raptor electrocutions in an urban environment. *J. Raptor Res.* 41:259–267.
- E. Oppenheimer & Son and BirdLife. 2010. Bustard beat, no. 1. South Africa. 21 pp.
- Eastwood, E. 1967. Radar ornithology. Methuen & Co. Ltd., London. 287 pp.
- *Edison Electric Institute. 2001. Introduction to public participation, revised third edition. Prepared by James L. Creighton, Creighton & Creighton, Inc. www.eei.org/products_and_services/descriptions_and_access/intro_pub_partic.htm
- *_____. 2010. Statistical yearbook of the electric utility industry. Edison Electric Institute. Available from: <http://www.eei.org>
- *EDM International, Inc. (EDM). 2004. Corona testing devices used to mitigate bird collisions. California Energy Commission, PIER Energy-Related Environmental Research. Technical Report 500-04-086F.
- Electric Power Research Institute (EPRI). 1993. Proceedings: avian interactions with utility structures. International Workshop, 13–16 September 1992. EPRI Technical Report TR-103268.

- * _____. 2001. Avian interactions with utility and communication structures workshop proceedings. 2–3 December 1999. Charleston, SC. EPRI Technical Report No. 1006907. R. Carlton, Project Manager.
- * _____. 2003. Bird strike indicator/bird activity monitor and field assessment of avian fatalities. EPRI, Palo Alto, CA; Audubon National Wildlife Refuge, Coleharbor, ND; Edison Electric Institute, Washington, D.C.; Bonneville Power Administration, Portland, OR; California Energy Commission, Sacramento CA; North Western Energy, Butte, MT; Otter Tail Power Company, Fergus Falls, MN; Southern California Edison, Rosemead, CA; Western Area Power Administration, Lakewood, CO.
- * _____. 2006. EPRI-GTC overhead electric transmission line siting methodology. EPRI, Palo Alto, CA, and Georgia Transmission Corporation, Tucker, GA. 1013080.
- _____. 2010. 2010 Research portfolio. Rights-of-way, siting, vegetation management, and avian issues, program 57. <http://portfolio.epri.com/ProgramTab.aspx?Id=ENV&Id=134&pId=5117>
- Electrical World. July 1986. Boost visibility of OH conductors. 44 pp.
- *Emerson, W. O. 1904. Destruction of birds by wires. *Condor* 6:37–38.
- Endler, J. A., and M. Thery. 1996. Interacting effects of Lek placement, display behavior, ambient light, and color patterns in three neotropical forest-dwelling birds. *Am. Nat.* 148:421–452.
- *Endangered Wildlife Trust (EWT). 2011. Wildlife & Energy Programme (WEP). www.ewt.org.za/WHATWEDO/OurProgrammes/WildlifeEnergyProgramme.aspx
- *Erickson, W. P., G. D. Johnson, M. D. Strickland, D. P. Young Jr., K. J. Sernka, and R. E. Good. 2001. Avian collisions with wind turbines: a summary of existing studies and comparisons to other sources of avian collision mortality in the United States. National Wind Coordinating Committee, RESOLVE, Inc., Washington, D.C.
- *_____, _____, and D. P. Young, Jr. 2005. A summary and comparison of bird mortality from anthropogenic causes with an emphasis on collisions. USDA USFS Gen. Tech. Rep. PSW-GTR-191.
- *Erwin, R. M. 1977. Foraging and breeding adaptations to different food regimes in three seabirds: the common tern (*Sterna hirundo*), royal tern (*Sterna maxima*), and black skimmer (*Rynchops niger*). *Anim. Behav.* 27:1054–1062.
- *Eskom. 2003. The management of wildlife interactions with overhead power lines. African Centre for Energy and Environment (ACEE). Johannesburg, South Africa. 72 pp.
- Eskom Transmission. 2005. Transmission bird collision guidelines. Johannesburg, South Africa. 21 pp.
- _____. 2008. Specifications for bird flight diverter installation on a transmission line. Johannesburg, South Africa. 1 p.
- *_____. 2009. Transmission bird collision prevention guidelines. Johannesburg, South Africa. 10 pp.
- Evans, W. R., Y. Akashi, N. S. Altman, and A. M. Manville, II. 2007. Response of night-migrating birds in clouds to colored and flashing light. *North American Birds* 60:476–488.

- Faanes, C. A. 1983. Assessment of power line siting in relation to bird strikes in the northern Great Plains. U.S. Fish and Wildlife Service, Jamestown, ND. 105 pp.
- * _____. 1987. Bird behavior and mortality in relation to power lines in prairie habitats. U.S. Fish and Wildlife Service. Serv. Gen. Tech. Rep. 7. 24 pp.
- Finger, E., and D. Burkhardt. 1994. Biological aspects of bird colouration and avian colour vision including ultraviolet range. *Vision Res.* 34:1509–1514.
- * Frost, D. 2008. The use of ‘flight diverters’ reduces mute swan (*Cygnus color*) collision with power lines at Abberton Reservoir, Essex, England. *Conservation Evidence* 5:83–91.
- * García-Montijano, M., A. M. Tébar, B. Barreiro, P. Rodríguez, J. C. Alonso, C. Martín, M. Magaña, C. Palacín, J. Alonso, A. Montesinos, and I. Luaces. 2002. Postmortem findings in wild great bustards (*Otis tarda*) from Spain: a clinical approach. European Association of Zoo and Wildlife Veterinarians (EAZWV) 4th scientific meeting, joint with the annual meeting of the European Wildlife Disease Association (EWDA). May 8–12, 2002, Heidelberg, Germany.
- Gauthreaux, S. A., Jr. 1970. Weather radar quantification of bird migration. *BioScience* 20:17–20.
- _____. 1972. Behavioral responses of migrating birds to daylight and darkness: a radar and direct visual study. *Wilson Bull.* 84:136–148.
- * _____. 1978a. Migratory behavior and flight patterns. Pages 23–50 in M. L. Avery (ed.), *Impacts of transmission lines on birds in flight*. FWS/OBS-78/48. U.S. Fish and Wildlife Service, Washington, D.C.
- _____. 1978b. The impact of transmission lines on migratory birds: assessment of completed, ongoing, and planned research and an analysis of future research needs. Consultant’s Report. Prepared for the Electric Power Research Institute, Palo Alto, CA. 43 pp.
- _____. 1980. Direct visual and radar methods for the detection, quantification, and prediction of bird migration. Special Publication No. 2, Department of Zoology, Clemson University, Clemson, SC. 67 pp.
- _____. 1981. Avian interactions with transmission lines: radar and direct visual methods of study, phase I. Final Technical Report. Electric Power Research Institute, Palo Alto, CA. 42 pp.
- _____. 1984. The use of small mobile radars to detect, monitor, and quantify bird movement. Pages 121–131 in M. J. Harrison, S. A. Gauthreaux, and L. A. Abron-Robinson (eds.), *Proc. of the Wildlife Hazards to Aircraft Conference and Training Workshop*, Charleston, SC. Federal Aviation Administration. DOT/FAA/AAS/84-1.
- _____. 1985. Radar, electro-optical, and visual methods of studying bird flight near transmission lines. Electric Power Research Institute. EPRI EA-4120. 76 pp.
- _____. 1988. The behavioral responses of migrating birds to aircraft strobe lights: attraction or repulsion? Final Technical Report. Headquarters, United States Air Force/Air Force Systems Command, Air Force Engineering and Services Center, Tyndall Air Force Base, FL 32403.
- _____. 1991. Low altitude movements of birds through the corridor for the Isle of Palms 115 kV TAP. Prepared for The South Carolina Electric & Gas Company, Columbia, SC. 121 pp.

_____. 1995. Suggested practices for monitoring bird populations, movements and mortality in wind resource areas. *In Proc. of the National Avian-Wind Power Planning Meeting*, 20–21 July 1994. Lakewood, CO.

* _____, and C. G. Belser. 2003. Overview radar ornithology and biological conservation. *Auk* 120(2):266–277.

* Gehring, J., P. Kerlinger, and A. M. Manville, II. 2009. Communication towers, lights, and birds: successful methods of reducing the frequency of avian collisions. *Ecol. Appl.* 19:505–514.

* _____, _____, and _____. 2011. The role of tower height and guy wires on avian collisions with communication towers. *J. Wildlife Manage.* 75(4):848–855.

Gilbert Commonwealth, Inc. 1985. A review of available bird collision information and description of submarine cable crossing impacts. Conducted for Central Power and Light Company. Jackson, MI. 16 pp.

* Gill, F. B. 1995. *Ornithology*. Second edition. W. H. Freeman and Company, New York.

Gill, J. A., W. J. Sutherland, and A. R. Watkinson. 1996. A method to quantify the effects of human disturbance on animal populations. *J. Appl. Ecol.* 33:786–792.

* Gill, J. P., M. Townsley, and G. P. Mudge. 1996. Review of the impacts of wind farms and other aerial structures upon birds. Scottish Natural Heritage Review No. 21. Scottish Natural Heritage, Edinburgh.

* Gombobaatar, S., R. Harness, and P. Amartuvshin. 2010. Raptor surveys of high power electric lines and avian protection plans in the Mongolian steppe. National University of Mongolia, Asia Research Center. Report 2009.04.01-2010.04.01.

Hager, S. B. 2009. Human-related threats to urban raptors. *J. Raptor Res.* 43:210–226.

Halverson, B. G., S. J. Syracuse, R. Clark, and F. M. Tesche 2008. Non-contact sensor system for real-time high-accuracy monitoring of overhead transmission lines. *In Proc. of the EDM and EPRI Internatl. Conf. on Overhead Lines*. 31 March–3 April 2008. Fort Collins, CO.

Hamer Environmental, L.P. 2008. Use of modified horizontal and vertical radar to investigate avian collision potential near proposed or existing overhead lines. Pages 137–141 *in Proc. of the EDM and EPRI Internatl. Conf. on Overhead Lines*. 31 March–3 April 2008. Fort Collins, CO.

Harden, J., 2002. An overview of anthropogenic causes of avian mortality. *J. Wildlife Rehabil.* 25:4–11.

* Harmata, A. R., K. M. Podruzy, J. R. Zelenak, and H. Gabler. 1997. Temporal and spatial profile of avian movement and mortality before and after installation of a 100 kV transmission line over the Missouri River. Montana Fish and Wildlife Program, Montana State University, Bozeman, MT. 42 pp.

* Harness, R., S. Milodragovich, and J. Schomburg. 2003. Raptors and power line collisions. *Colorado Birds* 37(3).

_____, S. Gombobaatar, and R. Yosef. 2008. Mongolia distribution power lines and raptor electrocutions. *Institute of Electrical and Electronics Engineers* 52:1–6.

- Harrison, J. 1963. Heavy mortality of Mute Swan from electrocution. *Wildfowl Trust Ann. Rep.* 14:164–165.
- *Hart, N., J. Partridge, and I. Cuthill. 1998. Visual pigments, oil droplets and cone photoreceptor distribution in the European starling (*Sturnus vulgaris*). *J. Exp. Biol.* 201:I433–I446.
- *Hartman, P. A., S. Byrne, and M. F. Dedon. 1992. Bird mortality in relation to the Mare Island 115-kV transmission line: final report 1988–1991. Prepared for Department of the Navy, Western Division, San Bruno, CA 94066-2402. PG&E Report Number 443-9I.3. 118 pp.
- *Heck, N. 2007. A landscape-scale model to predict the risk of bird collisions with electric power transmission lines in Alberta. M.E. Des Thesis, University of Calgary, Calgary, Alberta Canada.
- Heijinis, R. 1976. Vogels onderweg [Birds underway]. Ornithological mortality and environmental aspects of aboveground high tension lines. Koog aan de Zaan, Holland. 160 pp.
- _____. 1980. Vogeltod durch Drahtanflüge bei Hochspannungsleitungen [Bird death by wire approaches in high-voltage lines]. *Ökol. Vögel* 2:111–129.
- *Henderson, I. G., R. H. W. Langston, and N. A. Clark. 1996. The response of common terns (*Sterna hirundo*) to power lines: an assessment of risk in relation to breeding commitment, age and wind speed. *Biol. Conserv.* 77:185–192.
- Herbert, A. D. 1970. Spatial disorientation in birds. *Wilson Bull.* 82:400–419.
- *Herren, H. 1969. The status of the peregrine falcon in Switzerland. Pages 231–238 in *Peregrine Falcon Population: Their Biology and Decline*. University of Wisconsin Press, Madison.
- *Hiltunen, E. 1953. On electric and telephone wire incidents in birds. *Suomen Riista* 8: 70–76, 222–223.
- *Homan, H. J., G. Linz, and B. D. Peer. 2001. Dogs increase recovery of passerine carcasses in dense vegetation. *Wildlife Soc. B.* 29:292–296.
- Houston, C. S., and F. Scott. 2006. Entanglement threatens ospreys at Saskatchewan nest. *J. Raptor Res.* 40:226–228.
- Howard, R. P., B. L. Keller, F. L. Rose, J. Connley, Jr., and J. Hupp. 1987. Impacts of the Tincup Loop transmission line on cranes in Caribou County, Idaho. Pages 140–144 in J. C. Lewis (ed.), *Proc. 1985 Crane Workshop*. Platte River Whooping Crane Maintenance Trust, Grand Island, NE.
- Hugie, R. D., J. M. Bridges, B. S. Chanson, and M. Skougard. 1992. Results of a post-construction bird monitoring study on the Great Falls-Conrad 230-kV transmission line. Prepared by BIO/WEST, Inc., Logan, UT for Western Area Power Administration. 17 pp.
- Hunt, F. R. 1975. Automatic radar equipment to determine bird strike probability, part I. Night-time passerine migration. National Research Council of Canada, Ottawa, Field Note No. 69, p. 24.
- *Hunting, K. 2002. A roadmap for PIER research on avian collisions with power lines in California. California Energy Commission, PIER Energy-Related Environmental Research. Technical Report P500-02-071F.

- *Hurst, N. 2004. Corona testing of devices used to mitigate bird collisions. EDM International, Inc. California Energy Commission, PIER Energy-Related Environmental Research. 500-04-086F.
- *Huso, M. P. 2011. An estimator of wildlife fatality from observed carcasses. *Environmental Metrics* 22:318–329.
- Hylton, R. A., P. C. Frederick, T. E. De La Fuente, and M. G. Spalding. 2006. Effects of nestling health on postfledging survival of wood storks. *Condor* 108:97–106.
- Igl, L. D., and D. H. Johnson. 1985. Migratory bird population changes in North Dakota. In E. T. LaRoe, G. S. Farris, C. E. Puckett, P. D. Doran, and M. J. Mac (eds.), *Our living resources: a report to the nation on the distribution, abundance, and health of U.S. plants, animals, and ecosystems*. U.S. Department of the Interior, National Biological Service, Washington, D.C.
- Imber, M. J. 1975. Behavior of petrels in relation to the moon and artificial lights. *Notornis* 22:302–306.
- Inouye, D. W., B. Barr, K. B. Armitage, and B. D. Inouye. 2000. Climate change is affecting altitudinal migrants and hibernating species. *Proc. of National Academy of Sciences* 97:1630–1633.
- *James, B. W., and B. A. Haak. 1979. Factors affecting avian flight behavior and collision mortality at transmission lines. Bonneville Power Administration, U.S. Department of Energy, Portland, OR. 109 pp.
- *_____, and _____. 1980. Impact of the Ashe-Slatt 500-kV transmission line on birds at Crow Butte Island: pre-construction study. Bonneville Power Administration, U.S. Department of Energy, Portland, OR. 98 pp.
- *Janss, G. F. E. 2000. Avian mortality from power lines: a morphologic approach of a species-specific mortality. *Biol. Conserv.* 95:353–359.
- *_____, and M. Ferrer. 1998. Rate of bird collision with power lines: effects of conductor-marking and static wire-marking. *J. Field Ornithol.* 69:8–17.
- *_____, and _____. 2000. Common crane and great bustard collision with power lines: collision rate and risk exposure. *Wildlife Soc. B.* 28:675–680.
- _____, A. Lazo, and M. Ferrer. 1999. Use of raptor models to reduce avian collisions with power lines. *J. Raptor Res.* 33:154–159.
- *Jenkins, A. R., J. J. Smallie, and M. Diamond. 2010. Avian collisions with power lines: a global review of causes and mitigation with a South African perspective. *Bird Conserv. Int.* 20:263–278.
- *Johnson, G. D., W. P. Erickson, M. D. Strickland, M. F. Shepherd, D. A. Shepherd, and S. A. Sarappo. 2002. Collision mortality of local and migrant birds at a large-scale wind-power development on Buffalo Ridge, Minnesota. *Wildlife Soc. B.* 30:879–887.
- Jones, J., and C. M. Francis. 2003. The effects of light characteristics on avian mortality at lighthouses. *J. Avian Biol.* 34:328–333.
- *Jones, M. P., K. E. Pierce, Jr., and D. Ward. 2007. Avian vision: a review of form and function with special consideration to birds of prey. *J. Exot. Pet Med.* 2:69–87.

- Kabouche, B., J. Bayeul, L. Zimmermann, and P. Bayle. 2006. La mortalité des oiseaux sur le réseau électrique aérien: enjeux et perspectives en Provence-Alpes-Côte d'Azur [The mortality of birds on aerial power lines: challenges and prospects in Provence-Alpes-Cote d'Azur]. Rapport DIREN PACA - LPO PACA, Hyères. 109 pp.
- * Kelly, A., and S. Kelly. 2005. Are mute swans with elevated blood lead levels more likely to collide with overhead power lines? *Waterbirds* 28:331–334.
- * Kerlinger, P. 2003. Addendum to the phase I avian risk assessment for the Flat Rock Wind Power Project, Lewis County, New York: phase one and phase two. Prepared for Atlantic Renewable Energy Corporation, William Moore, Project Manager. Prepared by Curry & Kerlinger, LLC, Cape May, NJ.
- * Kessler, A. 2007. Great bustard in Central Asia: Tsengel died due to collision with power line. www.public.asu.edu/~akessler
- Kjaersgaard, A., C. Pertoldi, V. Loeschcke, and D. W. Hansen. 2008. Tracking the gaze of birds. *J. Avian Biol.* 39:466–469.
- Klem, D., Jr. 1990. Collisions between birds and windows: mortality and prevention. *J. Field Ornithol.* 61:120–128.
- _____. 2009. Avian mortality at windows: the second largest human source of bird mortality on earth. Pages 244–251 in T. D. Rich, C. Arizmendi, D. Demarest, and C. Thompson (eds.), *Tundra to tropics: connecting habitats and people*. Proc. of the 4th International Partners in Flight Conference, 13–16 February 2008, McAllen, TX.
- _____, D. C. Keck, K. L. Marty, A. J. Miller Ball, E. E. Niciu, and C. T. Platt. 2004. Effects of window angling, feeder placement, and scavengers on avian mortality at plate glass. *Wilson Bull.* 116:69–73.
- _____, C. J. Farmer, N. Delacretaz, Y. Gelb, and P. G. Saenger. 2009. Architectural and landscape risk factors associated with bird-glass collisions in an urban environment. *Wilson J. Ornithol.* 121:126–134.
- Klimentjew, D., N. Hendrich, J. Zhang. 2010. Multi sensor fusion of camera and 3D laser range finder for object recognition. *In proceedings of Multisensor Fusion and Integration for Intelligent Systems, 2010 IEEE Conference*. 5–7 September 2010, Salt Lake City, UT.
- Koford, C. B. 1953. The California condor. *Natl. Audubon Soc. Res. Rep.* 4. 154 pp.
- * Koops, F. B. J. 1979. Een miljoen draadslachtoffers wat kunnen we ertegen doen? [One million bird collisions: what can we do to improve this situation?] *De Lepelaar*, No. 63:20-21.
- * _____. 1987. Collision victims of high-tension lines in the Netherlands and effects of marking. KEMA Report 01282-MOB 86-3048.
- * _____. 1993. Collision victims of high-tension lines in the Netherlands and effects of marking. Unpubl. rep., N. V. KEMA, Arnhem. 6 pp.
- * _____, and J. de Jong. 1982. Vermindering van draadslachtoffers door markering van hoogspanningsleidingen in de omgeving van Heerenveen [Reducing the number of bird collisions by marking high-voltage lines in the Heerenveen area]. *Overdruk uit: Elektrotechniek* 60(12):641–646.
- Korschgen, C. D., W. L. Green, W. L. Flock, and E. A. Hibbard. 1984. Use of radar with a stationary antenna to estimate birds in a low-level flight corridor. *J. Field Ornithol.* 55:369–375.

- *Kostecke, R. M., G. M. Linz, and W. J. Bleier. 2001. Survival of avian carcasses and photographic evidence of predators and scavengers. *J. Field Ornithol.* 72:439–447.
- *Krapu, G. L. 1974. Avian mortality from collisions with overhead wires in North Dakota. *The Prairie Naturalist* 6:1–6.
- Krochko, N. 2005. Bird collisions with electric power transmission lines: frequently asked questions (FAQs). AltaLink, Calgary, Alberta, Canada. 5 pp.
- Kroodsma, R. L. 1978. Evaluation of a proposed transmission line's impact on waterfowl and eagles. Pages 69–76 *in* M. L. Avery (ed.), *Impacts of transmission lines on birds in flight*. FWS/OBS-78/48. U.S. Fish and Wildlife Service, Washington, D.C.
- Krüger, O. 2002. Analysis of nest occupancy and nest reproduction in two sympatric raptors: common buzzard (*Buteo buteo*) and goshawk (*Accipiter gentilis*). *Ecography* 25:523–532.
- _____, R. Liviersidge, and J. Lindström. 2002. Statistical modeling of the population dynamics of a raptor community in a semi-desert environment. *J. Anim. Ecol.* 71:603–613.
- Kunz, T. H., E. B. Arnett, B. M. Cooper, W. P. Erickson, R. P. Larkin, T. Mabee, M. L. Morrison, M. D. Strickland, and J. M. Szwczak. 2007. Assessing impacts of wind energy development on nocturnally active birds and bats: a guidance document. *J. Wildlife Manage.* 71:2249–2486.
- *Kuyt, E. 1992. Aerial radio-tracking of whooping cranes migrating between Wood Buffalo National Park and Aransas National Wildlife Refuge, 1981–84. Occasional Paper Number 74. Canadian Wildlife Service, Ottawa, Canada.
- Larkin, R. P., and P. J. Sutherland. 1977. Migrating birds respond to project seafarer's electromagnetic field. *Science* 195:777–779.
- *Lasch, U., S. Zerbe, and M. Lenk. 2010. Electrocutation of raptors at power lines in Central Kazakhstan. *Waldökologie, Landschaftsforschung, und Naturschutz* 9 (2010) [Forest Ecology, Landscape Research, and Nature Conservation 9 (2010)] http://afsv.de/download/literatur/waldoekologie-online/waldoekologie-online_heft-9-2.pdf
- Lawson, A. B., and M. J. Wyndham. 1993. A system of monitoring wildlife interactions with electricity distribution installations in a supply region of the Cape Province in Southern Africa. *In Proc. of the Avian Interactions with Utility Structures International Workshop*, 13–16 September 1992. Electric Power Research Institute and the Avian Power line Interaction Committee. EPRI Technical Report TR-103268.
- Ledger, J. A., J. C. A. Hobbs, and T. V. Smith. 1993. Avian interactions with utility structures: southern African experiences. *In Proc. of the Avian Interactions with Utility Structures International Workshop*, 13–16 September 1992. Electric Power Research Institute and the Avian Power line Interaction Committee. EPRI Technical Report TR-103268.
- *Lee, J. M., Jr. 1978. A summary of reports of bird collisions with power and communication lines. Bonneville Power Administration, Portland, OR. 8 pp.
- _____. 1983. Site visit and data analysis: waterfowl collisions at the Missouri River. Bonneville Power Administration, Portland, OR. 14 pp.

- * ____, and J. R. Meyer. 1977. Work plan for a study of the effects of Bonneville Power Administration transmission lines on bird flight behavior and collision mortality. Unpubl. Research Proposal, Bonneville Power Administration, Portland, OR. 9 pp.
- ____, and _____. 1978. Effects of transmission lines on bird flights: studies of Bonneville Power Administration Lines. Pages 93–116 in M. L. Avery (ed.), *Impacts of transmission lines on birds in flight*. U.S. Fish and Wildlife Service, Washington, D.C.
- Lehman, R. N., P. L. Kennedy, and J. A. Savidge. 2007. The state of the art in raptor electrocution research: a global review. *Biol. Conserv.* 136:159–174.
- Leitner, P., and G. S. Grant. 1978. Preliminary observations of waterbird flight patterns at Salton Sea, California, October 1976–February 1977. Prepared jointly for the Department of Energy and Southern California Edison. 34 pp.
- Leppers, P. H. 1966. Hoogspanningsdraden: doodsvijand nr. 1 [High-voltage wires: deadly enemy no. 1]. *Duivengazet* 19:16–17.
- * Lewis, J. C. 1992. The contingency plan for Federal-State cooperative protection of whooping cranes. Pages 293–300 in D. A. Wood (ed.), *Proc. 1988 N. Am. Crane Workshop*. Florida Game and Fresh Water Fish Commission, Tallahassee.
- Liguori, S., and J. Burruss. 2008. PacifiCorp's bird management program: integrating reactive, proactive, and preventative measures to reduce avian mortality on power lines. Pages 325–329 in J. W. Goodrich-Mahoney, L. P. Abrahamson, J. L. Ballard, and S. M. Tikalsky (eds.), *Proc. of the Eighth International Symposium on Environmental Concerns in Rights-of-Way Management*. 12–16 September 2004, Saratoga Springs, NY. Elsevier, Amsterdam, The Netherlands.
- Linz, G. M., J. E. Davis, Jr., R. M. Engeman, D. L. Otis, and M. L. Avery. 1991. Estimating survival of bird carcasses in cattail marshes. *Wildlife Soc. B.* 19:195–199.
- * Lislevand, T. 2004. Fugler og kraftledninger: metoder for å redusere risikoen for kollisjoner og elektrokusjon [Birds and power lines: methods to reduce the risk of collisions and electrocutions]. Norsk Ornitologisk Forening. Rapport nr 2-2004. 40 s.
- Longcore, T., C. Rich, and S. A. Gauthreaux, Jr. 2008. Height, guy wires, and steady-burning lights increase hazard of communication towers to nocturnal migrants: a review and meta-analysis. *Auk* 125:485–492.
- * ____, ____, P. Mineau, B. MacDonald, D. G. Bert, L. M. Sullivan, E. Mutrie, S. A. Gauthreaux Jr., M. L. Avery, R. L. Crawford, A. M. Manville II, E. R. Travis, and D. Drake. 2012. An estimate of avian mortality at communication towers in the United States and Canada. *PLoS ONE* 7(4), April 25th.
- * Longridge, M. W. 1986. The impacts of transmission lines on bird flight behaviour, with reference to collision mortality and systems reliability. *Bird Res. Comm., ESCOM*. Report: I-279.
- Luman, I. D. 1978. The Klamath Basin case. Pages 91–104 in M. L. Avery (ed.), *Impacts on transmission lines on birds in flight*. U.S. Fish and Wildlife Service, Washington, D.C. FWS/OBS-78/48.
- * Mabee, T. J., and B. A. Cooper. 2002. Nocturnal bird migration at the Stateline and Vansycle Wind Energy Projects, 2000–2001. Prepared for CH₂MHILL and FPL Energy Vansycle, LLC, Juno Beach, FL, by ABR, Inc., Forest Grove, OR. 16 p.

- * ____, ____, and J. H. Plissner. 2004. Radar study of nocturnal bird migration at the proposed Mount Storm Wind-Power Development, West Virginia, fall 2003. Final Report. Prepared for Western EcoSystems Technology (WEST), Inc., Cheyenne, WY, and NedPower US LLC, Chantilly, VA, by ABR, Inc., Forest Grove, OR.
- Maehr, D. S., A. G. Spratt, and D. K. Voights. 1983. Bird casualties at a central Florida power plant. *Florida Field Nat.* 11:45–49.
- * Magyar Madártani és Természetvédelmi Egyesület (MME). 2011. Budapest declaration on bird protection and power lines. Adopted by the conference, Power lines and bird mortality in Europe; Budapest, Hungary; 13 April 2011. www.mme.hu/termeszettvedelem/budapest-conference-13-04-2011/1429.html
- * Malcolm, J. M. 1982. Bird collisions with a power transmission line and their relation to botulism at a Montana wetland. *Wildlife Soc. B.* 10:297–304.
- * Mañosa, S., and J. Real. 2001. Potential negative effects of collisions with transmission lines on a Bonelli's Eagle population. *J. Raptor Res.* 35:247–252.
- Mantyla, E., T. Klemola, P. Sirkia, and T. Laaksonen. 2008. Low light reflectance may explain the attraction of birds to defoliated trees. *Behav. Ecol.* 19:325–330.
- * Manville, A. M., II. 2002. Protocol for monitoring the impact of cellular telecommunication towers on migratory birds within the Coconino, Prescott, and Kaibab National Forests, Arizona. Research Protocol Prepared for U.S. Forest Service Cellular Telecommunications Study. U.S. Fish and Wildlife Service, Division of Migratory Bird Management.
- * ____. 2005a. Bird strikes and electrocutions at power lines, communication towers, and wind turbines: state of the art and state of the science, next steps toward mitigation. Pages 1051–1064 in C. J. Ralph and T. D. Rich (eds.), *Bird conservation implementation in the Americas*. Proc. of the 3rd International Partners in Flight Conference 2002. USDA Forest Service General Technical Report PSW-GTR-191, Pacific Southwest Research Station, Albany, CA.
- * ____. 2005b. Seabird and waterbird bycatch in fishing gear: next steps in dealing with a problem. Pages 1071–1082 in C. J. Ralph and T. D. Rich (eds.), *Bird conservation implementation in the Americas*. Proc. of the 3rd International Partners in Flight Conference 2002. USDA Forest Service General Technical Report PSW-GTR-191, Pacific Southwest Research Station, Albany, CA.
- * ____. 2007a. Comments of the U.S. Fish and Wildlife Service submitted electronically to the FCC on 47 CFR parts 1 and 17, WT Docket 03-187, FCC 06-164, Notice of Proposed Rulemaking, "Effects of Communication Towers on Migratory Birds." February 2, 2007. 32 pp.
- _____. 2007b. Briefing paper on the need for research into the cumulative impacts of communication towers on migratory birds and other wildlife in the United States. Division of Migratory Bird Management, U.S. Fish and Wildlife Service, Arlington, VA, for Public Release.
- * ____. 2009a. Towers, turbines, power lines, and buildings: steps being taken by the U.S. Fish and Wildlife Service to avoid or minimize take of migratory birds at these structures. Pages 262–272 in T. D. Rich, C. Arizmendi, D. Demarest, and C. Thompson (eds.), *Tundra to tropics: connecting habitats and people*. Proc. of the 4th International Partners in Flight Conference, 13–16 February 2008, McAllen, TX.

- * _____. 2009b. Briefing paper on the need for research into the cumulative impacts of communication towers on migratory birds and other wildlife in the United States: document for public release. U.S. Fish and Wildlife Service, Division of Migratory Bird Management.
- Manville, R. H. 1963. Accidental mortality in bats. *Mammalia* 27:361–366.
- Martin, G. R. 2010. Bird collisions: a visual or a perceptual problem? *In Proc. of the British Ornithologists' Union 2010 Conference: Climate Change and Birds*. 6–8 April 2010. University of Leicester, Leicester, UK.
- * _____. 2011. Understanding bird collisions with man-made objects: A sensory ecology approach. *Ibis* 153:239–254.
- * _____, and J. M. Shaw. 2010. Bird collisions with power lines: failing to see the way ahead? *Biol. Conserv.* 143: 2695–2702.
- * Mathiasson, S. 1999. Swans and electrical wires, mainly in Sweden. Pages 83–111 *in* M. Ferrer and G. F. E. Janss (eds.), *Birds and power lines: collision, electrocution and breeding*. Servicios Informativos Ambientales/Quercus, Madrid, Spain.
- * McCann, K. 2001. Eskom/EWT partnership: the wattled crane marking project in South Africa. *In Avian Interactions with Utility and Communication Structures Workshop Proceedings*. 2–3 December 1999. Charleston, SC. EPRI Technical Report No. 1006907. R. Carlton, Project Manager.
- McCrary, M. D., R. L. McKernan, and R. W. Schreiber. 1981. Nocturnal bird migration in the Coachella Valley, spring 1981. Prepared for Southern California Edison Company, Rosemead, CA. 42 pp.
- _____, _____, _____, and S. D. Wagner. 1988. Assessment of bird collisions along the Devers-Valley 500-kV transmission line in the San Jacinto Valley. Final Report. Southern California Edison, 88-RD-5.
- McKernan, R., M. McCrary, W. Wagner, R. Landry, and R. Schreiber. 1982. Observations on nocturnal and diurnal bird use in relation to the Devers-Valley 500-kV transmission line in the San Jacinto Valley, winter 1981–82. Prepared for Southern California Edison Company, Rosemead, CA. 63 pp.
- * McNeil, R., J. R. Rodriguez, and H. Ouellet. 1985. Bird mortality at a power transmission line in Northeastern Venezuela. *Biol. Conserv.* 31:153–65.
- _____, A. McSween, and P. Lachapelle. 2005. Comparison of the retinal structure and function in four bird species as a function of the time they start singing in the morning. *Brain Behav. Evolut.* 65:202–214.
- * Mead, C. J., P. M. North, and B. R. Watmough. 1979. The mortality of British grey herons. *Bird Study* 26:13–22.
- * Meyer, J. R. 1978. Effects of transmission lines on bird flight behavior and collision mortality. Prepared for Bonneville Power Administration, U.S. Department of Energy, Portland, OR. 200 pp.
- * Miller, A. D. 1990. A study to determine the effectiveness of power line marking systems to reduce avian collision mortality. Unpublished report for APLIC. 15 pp.
- * Mojica, E. K., B. D. Watts, J. T. Paul, S. T. Voss, and J. Pottie. 2009. Factors contributing to bald eagle electrocutions and line collisions on Aberdeen Proving Ground, Maryland. *J. Raptor Res.* 43:57–61.

- *Morkill, A. E., and S. H. Anderson. 1991. Effectiveness of marking power lines to reduce sandhill crane collisions. *Wildlife Soc. B.* 19:442–449.
- *Murphy, R. K., S. M. McPherron, G. D. Wright, and K. L. Serbousek. 2009. Effectiveness of avian collision averters in preventing migratory bird mortality from power line strikes in the Central Platte River, Nebraska. 2008–2009 Final Report. 30 September 2009, Dept. of Biology, University of Nebraska- Kearney, Kearney, NE. 32 pp.
- *National Park Service (NPS). 2011. California condor (*Gymnogyps californianus*) recovery program: population size and distribution, December 31, 2011. Available from: www.nps.gov/pinn/naturescience/upload/Condor-Program-Monthly-Status-One-Page-Summary-2011-12-3134.pdf
- Negro, J. J., and M. Ferrer. 1995. Mitigating measures to reduce electrocution of birds on power lines: a comment on Bevinger's review. *Ibis* 137:423–424.
- New York Power Authority (NYPA). 2005. Estimates of bird mortality associated with transmission lines. Niagara Power Project, FERC #2216. Prepared for NYPA by URS Corporation.
- Newton, I. 2007. Weather-related mass-mortality events in migrants. *Ibis* 149:453–467.
- *_____. 2008. *The migration ecology of birds*. Academic Press, Amsterdam, The Netherlands.
- Nielson, L. 2010. Bird collision monitoring with a BSI. Northwest Public Power Association, Avian Protection Plan Workshop. 16–17 March 2010. Seattle, WA.
- Niemi, G. J., and J. M. Hanowski. 1984. Effects of a transmission line on bird populations in the Red Lake Peatland, northern Minnesota. *Auk* 101:487–498.
- *NUS Corporation. 1979. Impacts of overhead wires on birds: a review. Unpublished report. Prepared for the Electric Power Research Institute, Palo Alto, Calif. 47 pp. Summary available from www.energy.ca.gov/research/environmental/avian_bibliography
- Nygård, T., K. Bevinger, and O. Reitan. 2008. Forholdet mellom fugler og vindmøller og andre lufthindringer. En litteraturoversikt [The relationship between birds and wind turbines and other air barriers. A literature review]. NINA Rapport 413. 167 s.
- Office of the President. 2001. Executive Order 13186 of January 10, 2001. Responsibilities of federal agencies to protect migratory birds. *Federal Register* 66:11 (17 January 2001). Pp 3853–3856. Available from: <http://www.archives.gov/federal-register/executive-orders/2001-clinton.html>
- *Ogilvie, M. A. 1966. Population changes and mortality of the mute swan in Britain. *Wildfowl Trust Ann. Rep.* 18:64–73.
- Olendorff, R. R., A. D. Miller, and R. N. Lehman. 1981. Suggested practices for raptor protection on power lines: the state of the art in 1981. Raptor Research Report No. 4, Raptor Research Foundation, Inc. 111 pp.
- *_____, _____, and _____. 1986. Raptor collisions with utility lines: an analysis using subjective field observations. Pacific Gas and Electric Co., San Ramon, CA. 73 pp.

- *Olson, C. 2001. Human-related causes of raptor mortality in western Montana: things are not always as they seem. *In Avian Interactions with Utility and Communication Structures Workshop Proceedings*. 2–3 December 1999. Charleston, SC. EPRI Technical Report No. 1006907.
- Padding, P. I., and H. H. Prince. 1991. Final report: Karn-Weadock transmission line mortality study. Department of Fisheries and Wildlife, Michigan State University, East Lansing, MI. 12 pp.
- *Pandey, A. K., R. E. Harness, and M. K. Schriener. 2008. Bird strike indicator field deployment at the Audubon National Wildlife Refuge in North Dakota: phase two. California Energy Commission, PIER Energy-Related Environmental Research Program. CEC-500-2008-020.
- Patten, M. A., and D. T. Bolger. 2003. Variation in top-down control of avian reproductive success across a fragmentation gradient. *Oikos* 101:479–488.
- *Peterson, C. A., S. L. Lee, and J. E. Elliott. 2001. Scavenging of waterfowl carcasses by birds in agricultural fields of British Columbia. *J. Field Ornithol.* 72:150–159.
- Philibert, H., G. Wobeser, and R. G. Clark. 1993. Counting dead birds: examination of methods. *J. Wildlife Dis.* 29:284–289.
- Ping, F., M. Farzaneha, and G. Boucharda. 2006. Two-dimensional modeling of the ice accretion process on transmission line wires and conductors. *Cold Reg. Sci. Technol.* 46:132–146.
- *Podolsky, R., D. G. Ainley, G. Spencer, L. Deforest, and N. Nur. 1998. Mortality of Newell's shearwaters caused by collisions with urban structures on Kauai. *Colon. Waterbird* 21:20–34.
- *Prather, P. R., and T. A. Messmer. 2010. Raptor and corvid response to power distribution line perch deterrents in Utah. *J. Wildlife Manage.* 74(4):796–800.
- Prinsen, H., and R. Smits. 2009. Collision risk of birds with a 150 kV power line: a case study from the Netherlands. Bureau Waardenburg, Ltd., The Netherlands.
- *Prosser, P. C., N. Natrass, and C. Prosser. 2008. Rate of removal of bird carcasses in arable farmland by predators and scavengers. *Ecotox. Environ. Safe.* 71:601–608.
- *Quinn, M., N. Heck, S. Alexander, and G. Chernoff. 2011. Identification of bird collision hotspots along transmission power lines in Alberta: an expert-based geographic information system (GIS) approach. *Journal of Environmental Informatics* 18(1):12–21.
- *Raavel, P., and J. C. Tombal. 1991. Impact des lignes haute-tension sur l'avifaune [Impact of high-voltage lines on birds]. *Les Cahiers de L'A.M.B.E. et Environnement*, Vol. 2. 31 pp.
- *Rasmussen, P. J. 2001. Problem resolutions for avian interactions at two NSP facilities. *In Proc. Avian Interactions with Utility and Communication Structures Workshop*. 2–3 December 1999. Charleston, SC. EPRI Technical Report No. 1006907.
- *Rayner, J. M. V. 1988. Form and function in avian flight. *Curr. Ornithol.* 5:1–77.
- Reijnen, R., R. Foppen, and G. Veenbaas. 1997. Disturbance by traffic of breeding birds: evaluation of the effect and considerations in planning and managing road corridors. *Biodivers. Conserv.* 6:567–581.

Reiter, A. S. 2000. Casualties of great bustards on overhead power lines in the western Weinvertel (Lower Austria). *Egretta* 43:37–54.

*Renssen, T. A., A. Bruin, J. H. van de Doorn, A. Gerritsen, H. C. Greven, and J. Kamp. 1975. Vogelsterfte in Nederland tengevolge van aanvaringen met hoogspanningslijnen [Bird mortality in the Netherlands due to collisions with power lines]. Rijksinstituut voor Natuurbeheer. 65 pp.

Richardson, W. J. 2000. Bird migration and wind turbines: migration timing, flight behavior, and collision risk. Pages 132–140 in National Avian-Wind Power Planning Meeting III. San Diego, CA, LGL Ltd., Environmental Research Associates, King City, Ontario, Canada.

*Rigby, R. W. 1978. October 19 letter from refuge manager, Bosque del Apache National Wildlife Refuge, Socorro, NM, to Michael Avery, National Power Plant Team, Ann Arbor, MI. 1 p.

*Rivera-Milan, F. F., M. E. Zaccagnini, and S. B. Canavelli. 2004. Field trials of line-transect surveys of bird carcasses in agro-ecosystems of Argentina's Pampas region. *Wildlife Soc. B.* 32:1219–1228.

Robbins, C. 2002. Direct testimony of Chandler S. Robbins Dec. 6, 2002, in the matter of the application of Clipper 101 MW generating facility in Garrett County, MD, Windpower, Inc. Case #8938.

*Robert, M., R. McNeil, and A. Leduc. 1989. Conditions and significance of night feeding in shorebirds and other water birds in a tropical lagoon. *Auk* 106:94–101.

*Rocke, T. E., and Friend, M. 1999. Avian botulism. Chapter 38 in *Field manual of wildlife diseases: General field procedures and diseases of birds*. U.S. Department of the Interior. U.S. Geological Survey.

*Roig-Soles, J., and V. Navazo-Lopez. 1997. A five-year Spanish research project on bird electrocution and collision with electric lines. Pages 317–325 in J. R. Williams, J. W. Goodrich-Mahoney, J. R. Wisniewski, and J. Wisniewski (eds.), *Environmental Concerns in Rights-of-Way Management*. 22–26, February. New Orleans, LA. Elsevier Science Ltd., Amsterdam, The Netherlands.

Ross, R. C. 1946. People in glass houses should draw their shades. *Condor* 48:142.

RTE. 2009. RTE Rhône-Alpes Auvergne: pose de balises de protection de l'avifaune par RTE dans la réserve naturelle régionale des étangs de Mépieu [RTE Rhône-Alpes Auvergne: Attaching tags to protect the birds by RTE in the regional natural reserve of ponds Mépieu]. Paris, France. 7 pp.

*Rubolini, D., M. Gustin, G. Bogliani, and R. Garavaglia. 2005. Birds and power lines in Italy: an assessment. *Bird Conserv. Int.* 15:131–145.

*Rusz, P. J., H. H. Price, R. D. Rusz, and G. A. Dawson. 1986. Bird collisions with transmission lines near a power plant cooling pond. *Wildlife Soc. B.* 14:441–444.

*Savareno, A. J., L. A. Savareno, R. Boettcher, and S. M. Haig. 1996. Avian behavior and mortality at power lines in coastal South Carolina. *Wildlife Soc. B.* 24:636–648.

*Schroeder, C. H. 1977. Geese hit power transmission line. *North Dakota Outdoors* 40(2): inside cover.

- *Schuereberg, B., R. Schneider, and H. Jerrentrup. 2009. Follow-up of recommendation No. II0 (2004) on minimising adverse effects of above-ground electricity transmission facilities (power lines) on birds. Council of Europe, Convention on the Conservation of European Wildlife and Natural Habitats, Standing Committee, 29th Meeting, 23–26 November. Bern, Switzerland. 39 pp.
- *Scott, R. E., L. J. Roberts, and C. J. Cadbury. 1972. Bird deaths from power lines at Dungeness. *Brit. Birds* 65:273–286.
- Seamans, T. W., S. C. Barras, and A. J. Patton. 2003. Are birds scared by rotating mirrors? *In Proc. of the 2003 Bird Strike Committee USA/Canada, 5th Joint Annual Meeting, Toronto, Ontario, Canada.*
- Sergio, F., P. Pedrini, and L. Marchesi. 2003. Spatio-temporal shifts in gradients of habitat quality for an opportunistic avian predator. *Ecography* 26:243–255.
- *Shamoun-Baranes, J., E. van Loon, H. van Gasteren, J. van Belle, W. Bouten, and L. Buurma. 2006. A comparative analysis of the influence of weather on the flight altitudes of birds. *B. Am. Meteorol. Soc.* 87:47–61.
- *_____, W. Bouten, and E. van Loon. 2010. Integrating meteorology into research on migration. *Integr. Comp. Biol.* 50:280–292.
- *Shaw, J., A. Jenkins, J. Smallie, and P. Ryan. 2010. Modeling power-line collision risk for the blue crane (*Anthropoides paradiseus*) in South Africa. *Ibis* 152:590–599.
- *Shernazarov, E., and E. N. Lanovenko. 1994. Assessment of impact of anthropogenic loads on ornithological fauna of Uzbekistan. Pages 32–35 *in* materials of seminar “Environmental Impact Assessment procedure during development of Feasibility Study and Designs of Construction of Economic Facilities and Complexes” Tashkent.
- *Shimada, T. 2001. Choice of daily flight routes of greater white-fronted geese: effects of power lines. *Waterbirds* 24:425–429.
- *Shire, G. G., K. Brown, and G. Winegrad. 2000. Communication towers: a deadly hazard to birds. Report Documents. A Report Compiled by American Bird Conservancy, June 2000.
- Siegfried, W. R. 1972. Ruddy ducks colliding with wires. *Wilson Bull.* 84:486–487.
- Simmons, R. E. 2002. Siblicide provides food benefits for raptor chicks: re-evaluating brood manipulation studies. *Anim. Behav.* 64:F19–F24.
- *Smallie, J., and M. Z. Virani. 2010. A preliminary assessment of the potential risks from electrical infrastructure to large birds in Kenya. *Scopus* 30:32–39.
- Smith, J. R., and J. T. Schletz. 1991. Bird/power line collision detection system. Final Report. Pacific Gas and Electric Company, Department of Research and Development.
- Sorenson, K. J., L. J. Burnett, and J. R. Davis. 2001. Status of the California condor and mortality factors affecting recovery. *Endangered Species Update*, July–August 2001.
- Stallknecht, D. E. 2007. Impediments to wildlife disease surveillance, research, and diagnostics. *Curr. Top. Microbiol.* 315:445–461.

Steenhof, K., M. N. Kochert, and J. A. Roppe. 1993. Nesting by raptors and common ravens on electrical transmission line towers. *J. Wildlife Manage.* 57:271–281.

* Stehn, T., and T. Wassenich. 2007. Whooping crane collisions with power lines: an issue paper. 2006 North American Crane Workshop.

Stout, J., and G. W. Cornwell. 1976. Non-hunting mortality of fledged North American waterfowl. *J. Wildlife Manage.* 40:681–693.

* Sundar, K. S. G., and B. C. Choudhury. 2005. Mortality of sarus cranes (*Grus antigone*) due to electricity wires in Uttar Pradesh, India. *Environ. Conserv.* 32:260–269.

Sundararajan, R., and R. Gorur. 2005. When birds and power lines collide. *Transmission and Distribution World*, December 2005:16–26.

Snyder, L. L. 1946. “Tunnel fliers” and window fatalities. *Condor* 48:278.

* Tacha, T. C., D. C. Martin, and C. G. Endicott. 1979. Mortality of sandhill cranes associated with utility highlines in Texas. Pages 175–176 in J. C. Lewis (ed.), *Proc. 1978 Crane Workshop*. National Audubon Society, NY.

Thompson, L. S. 1977. Overhead transmission lines: impact on wildlife. Montana Department of Natural Resources & Conservation, Helena, MT. 60 pp.

* _____. 1978. Transmission line wire strikes: mitigation through engineering design and habitat modification. Pages 51–92 in M. L. Avery (ed.), *Impacts of transmission lines on birds in flight*. U.S. Fish and Wildlife Service, Washington, D.C.

Todd, L. D., R. G. Poulin, and R. M. Brigham. 1997. Diet of common nighthawks (*Chordeiles minor*: Caprimulgidae) relative to prey abundance. *Am. Midl. Nat.* 139:20–28.

Tucker, W. A. 1975. Flight energetics. Pages 49–63 in M. Peaker (ed.), *Avian physiology*. Academic Press, London.

U.S. Department of Agriculture (USDA). 1985. USDA handbook 478. National Forest Landscaped Management, Volume 2, Chapter 2, Utilities.

U.S. Department of Energy (USDOE). 2007. National electric transmission corridor report and the ordered national corridor designations. <http://nietc.anl.gov/nationalcorridor/index.cfm>

* U.S. Environmental Protection Agency (USEPA). 1998. Guidelines for ecological risk assessment. U.S. Environmental Protection Agency, Risk Assessment Forum, Washington, D.C. EPA/630/R095/002F.

U.S. Fish and Wildlife Service (USFWS). Undated. Bird fatality/injury reporting program filer instructions. 16 pp.

* _____. 2005a. Final list of bird species to which the Migratory Bird Treaty Act does not apply. *Federal Register* 70:49 (15 March 2005). Pp 12710–12716. Available from: www.federalregister.gov/articles/2005/03/15.

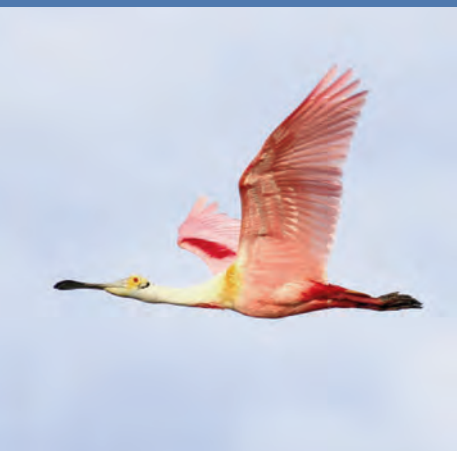
_____. 2005b. Collisions: Clear the way for birds. *International Migratory Bird Day*. 8 pp.

* _____. 2009a. Final environmental assessment. Proposal to permit take as provided under the Bald and Golden Eagle Protection Act. Available from: http://www.fws.gov/migratorybirds/CurrentBirdIssues/BaldEagle/FEA_EagleTakePermit_Final.pdf

- * _____. 2009b. Standard recommendations to avoid, minimize and mitigate potential impacts of wind energy projects in Oklahoma. Oklahoma Ecological Services Field Office, Tulsa, OK. 5 pp.
- _____. 2010. Species profile: California condor (*Gymnogyps californianus*). <http://ecos.fws.gov/speciesProfile/profile/speciesProfile.action?scode=B002>
- * ____ and National Marine Fisheries Service (NMFS). 1998. Consultation handbook: Procedures for conducting consultation and conference activities under Section 7 of the Endangered Species Act.
- * U.S. Geological Survey (USGS). 2011. National wildlife health center. www.nwhc.usgs.gov
- * Utah Wildlife in Need (UWIN). 2010. Contemporary knowledge and research needs regarding the potential effects of tall structures on sage-grouse (*Centrocercus urophasianus* and *C. minimus*). Available from: <http://utahcbcp.org/html/tall-structure-info>
- * _____. 2011. Protocol for investigating the effects of tall structures on sage-grouse (*Centrocercus* spp.) within designated or proposed energy corridors. Available from: <http://utahcbcp.org/html/tall-structure-info>
- van Rooyen, C. Undated. Bird impact scoping study Gerus-Mururane Gate 350kV DC transmission line. Endangered Wildlife Trust, South Africa. 19 pp.
- * _____. 2000. An overview of vulture electrocutions in South Africa. Vulture News 43: 5–22. Vulture Study Group, Johannesburg, South Africa.
- _____. 2001. Bird impact assessment study cape strengthening programme gamma-omega 765kV transmission line. Endangered Wildlife Trust, South Africa. 12 pp.
- _____. 2006. Environmental assessment addendum of the proposed Otjikoto–Katima Mulilo 350kV DC, ornithological component. Endangered Wildlife Trust, South Africa. 8 pp.
- * ____ and J. A. Ledger. 1999. Birds and utility structures: developments in South Africa. Pages 205–230 in M. Ferrer and G. F. E. Janss (eds.), Birds and power lines: collision, electrocution and breeding. Madrid: Quercus.
- * Ventana Wildlife Society. 2009. Evaluating diverter effectiveness in reducing avian collisions with distribution lines at San Luis National Wildlife Refuge complex, Merced County, California. California Energy Commission, PIER Energy-Related Environmental Research. CEC-500-2009-078.
- Verhiejn, F. J. 1958. The mechanisms of the trapping effect of artificial light sources upon animals. Arch. Neer. Zool. 13:1–107.
- Virginia Joint Commission on Technology and Science. Undated. Dominion estimated transmission costs: overhead vs. underground cost comparison 5 mile, 230 kV single circuit line example I035 MVA capacity initial cost analysis. Richmond, VA. 9 pp. <http://jcots.state.va.us/pdf/CostAnalysis.pdf>
- Viverette, C. B., S. Struve, L. J. Goodrich, and K. L. Bildstein. 1996. Decreases in migrating sharp-shinned hawks (*Accipiter striatus*) at traditional raptor-migration watch sites in eastern North America. Auk 113:32–40

- *Walkinshaw, L. H. 1956. Sandhill cranes killed by flying into a power line. *Wilson Bull.* 68:325–326.
- Weir, R. D. 1976a. Annotated bibliography of bird kills at man-made obstacles: a review of the state of the art and solutions. *Can. Wildl. Serv., Ont. Reg., Ottawa.* 85 pp.
- _____. 1976b. Bird kills at the Lennox Generating plant: spring and autumn 1976. *Blue Bill* 23:41–43.
- West, H. J., and G. G. Stults. 1980. A bird flight theodolite tracking system. Division of Laboratories Report No. ERFE-80-23. Bonneville Power Administration, U.S. Dept. of Energy, Portland, OR. 17 pp.
- *Western Area Power Administration (WAPA). 2011. Line marking study near Coleharbor, ND, 2006–2008: data and summary [webpage]. www.wapa.gov
- Western Systems Coordinating Council. December 1971. Environmental guidelines.
- *Wheeler, R. H. 1966. Sandhill crane casualties in the blizzard of March 22, 1966. *Nebr. Bird Rev.* 34:69–70.
- Wiese, J. C. 1979. Study of the reproductive biology of herons, egrets, and ibis nesting on Pea Patch Island, Delaware. Prepared for Delmarva Power and Light Company, Wilmington, DE. 255 pp.
- *Willard, D. E. 1978. The impact of transmission lines on birds (and vice versa). Pages 3–7 in M. L. Avery (ed.), *Impacts of transmission lines on birds in flight: proc. of a workshop.* Oak Ridge Associated Universities, Oak Ridge, TN. 31 January–2 February, 1978. U.S. Fish and Wildlife Service, Biological Services.
- _____, and B. J. Willard. 1978. The interaction between some human obstacles and birds. *Environ. Manage.* 2:331–340.
- *_____, J. T. Harris, and M. J. Jaeger. 1977. The impact of a proposed 500-kV transmission route on waterfowl and other birds. A Report for the Public Utility Commissioner of the State of Oregon. Salem, OR. 89 pp.
- _____, and _____. 1978. The impact of transmission lines on birds (and vice versa). Pages 5–13 in M. L. Avery (ed.), *Impacts of transmission lines on birds in flight.* U.S. Fish and Wildlife Service, Washington, D.C.
- *Willdan Associates. 1981. Impact of the Ashe-Slatt 500-kV transmission line on birds at Crow Butte Island: postconstruction study year I. Prepared for Bonneville Power Administration, U.S. Dept. of Energy, Portland, OR. 110 pp.
- *_____. 1982. Impact of the Ashe-Slatt 500-kV transmission line on birds at Crow Butte Island: postconstruction study final report. Prepared for Bonneville Power Administration, U.S. Dept. of Energy, Portland, OR. 155 pp.
- Williams, T. 2000. Zapped! *Audubon: January/February:* 32–34.
- Williams, T. C., J. Settel, P. O'Mahoney, and J. M. Williams. 1972. An ornithological radar. *American Birds* 26:555–557.
- _____, _____, _____, and _____. 1984. How to use marine radar for bird watching. *American Birds* 38:982–983.
- Wilmore, S. B. 1974. *Swans of the world.* Taplinger Publishing, New York.

- Wiltschko, R., T. Ritz, K. Stapput, P. Thalau, and W. Wiltschko. 2005. Two different types of light-dependent responses to magnetic fields in birds. *Curr. Biol.* 15:1518–1523.
- Wiltschko, W., and R. Wiltschko. 1999. The effect of yellow and blue light on magnetic compass orientation in European robins (*Erithacus rubecula*). *J. Comp. Physiol.* 184:295–299.
- _____, U. Munro, H. Ford, and R. Wiltschko. 1993. Red light disrupts magnetic orientation of migratory birds. *Nature* 364:525–527.
- Winkelman, J. E. 1992. De invloed van de Sep-proefwindcentrale te Oosterbierum op vogels [The impact of the September trial wind power station at Oosterbierum on birds]. 2. Nachtelijke aanvaringskansen. IBN-DLO, RIN-rapport 92/3.
- * _____. 1995. Bird/wind turbine investigations in Europe. Pages 43–47 in *Proc. of the National Avian-Wind Power Planning Meeting*, 20–21 July 1994, Lakewood, CO.
- Wobeser, G., and A. G. Wobeser. 1992. Carcass disappearance and estimation of mortality in a simulated die-off of small birds. *J. Wildlife Dis.* 28:548–554.
- Wolfe, D. H., M. A. Patten, E. Shochat, C. L. Pruett, and S. K. Sherrod. 2007. Causes and patterns of mortality in lesser prairie-chickens *Tympanuchus pallidicinctus* and implications for management. *Wildlife Biol.* 13:95–104.
- * Yee, M. L. 2007. Evaluating and reducing avian collisions with distribution power lines at Cosumnes River Preserve. California Energy Commission, Public Interest Energy Research (PIER) Program and California State University, Sacramento, CA.
- * _____. 2008. Testing the effectiveness of an avian flight diverter for reducing avian collisions with distribution power lines in the Sacramento Valley, CA. California Energy Commission, PIER Energy-Related Environmental Research Program. CEC-500-2007-122.
- Zapata-Sánchez, J. A., M. Carrete, A. Gravilov, S. Sklyarenko, O. Ceballos, J. A. Donazar, and F. Hiraldo. 2003. Land use changes and raptor conservation in steppe habitats of eastern Kazakhstan. *Biol. Conserv.* 111:71–77.
- Zimmerman, A. L., B. E. Jamison, J. A. Dechant, D. H. Johnson, C. M. Goldade, J. O. Church, and B. R. Euliss. 2002. Effects of management practices on wetland birds: sora. Northern Prairie Wildlife Research Center, Jamestown, ND. 31 pp.



APPENDIX B

Designing Site-Specific Studies for Collision Monitoring

With any study design for collision monitoring it is important that the resulting data can be compared to similar studies (see *Variability of Reported Mortality Rates* in Chapter 4 and *Effectiveness of Designs* in Chapter 6). The information in this

appendix will help you design site-specific study methods that produce useful and comparable results. Table B.I summarizes the considerations and issues presented in this appendix.

TABLE B.1: Summary of considerations and issues for designing site-specific collision monitoring.

Considerations for Site-Specific Collision Monitoring	Issues Related to Estimating Mortality Rates
Behavioral Monitoring <ul style="list-style-type: none"> • Bird density • Evaluation criteria • Estimating bird flight height • Radar observation and detection • Metrics • Study segments 	Equations for Calculating Mortality Rate <ul style="list-style-type: none"> • Accuracy • Variability in methods
Mortality Monitoring <ul style="list-style-type: none"> • Differences in sampling design • Questions to ask • Data to record • Remote sensing 	Sampling Biases <ul style="list-style-type: none"> • Crippling loss • Searcher efficiency • Scavenger removal • Habitat differences



CONSIDERATIONS FOR SITE-SPECIFIC COLLISION MONITORING

BEHAVIORAL MONITORING SURVEYS

The most direct way to determine how collisions are occurring is to observe behavior as birds are approaching, crossing, or colliding with power lines. Behavioral monitoring is used to characterize the birds' reaction to lines by giving each reaction a behavioral avoidance value. In line modification studies, behavioral monitoring can be used to measure the effectiveness of line marking devices.

Bird Density

Past studies (e.g., Bevanger 1999; Janss 2000) have counted collisions per flyby (observed collisions per number of birds flying by a line). With high bird density, counting collisions per flyby is feasible. But with low bird density, counting flybys is not practical because so few observations can be made, even over an extended period of time. Direct observation can be especially time consuming with low bird density or intermittent high bird density. Observations may also be restricted by poor visibility due to weather or time of day. In such cases, the most feasible method may be to conduct mortality monitoring to estimate collisions (see [Mortality Monitoring Surveys](#) on page I41). Bird collisions with power lines can also be detected with remote sensing devices (see [Remote Sensing](#) on page I42), although they do not yield behavioral and species data.

Evaluation Criteria

A study's behavioral criteria may include the type of reaction to lines, distance from the line when the reaction occurred, and height above the line when crossing. Because estimates are provided by different observers, all observers must be trained and given time to practice before the study begins, and the same observers should be used throughout the study when possible to minimize observer bias. Records of approach, crossing, and departure heights should be kept. If behavioral avoidance is observed, the reaction to

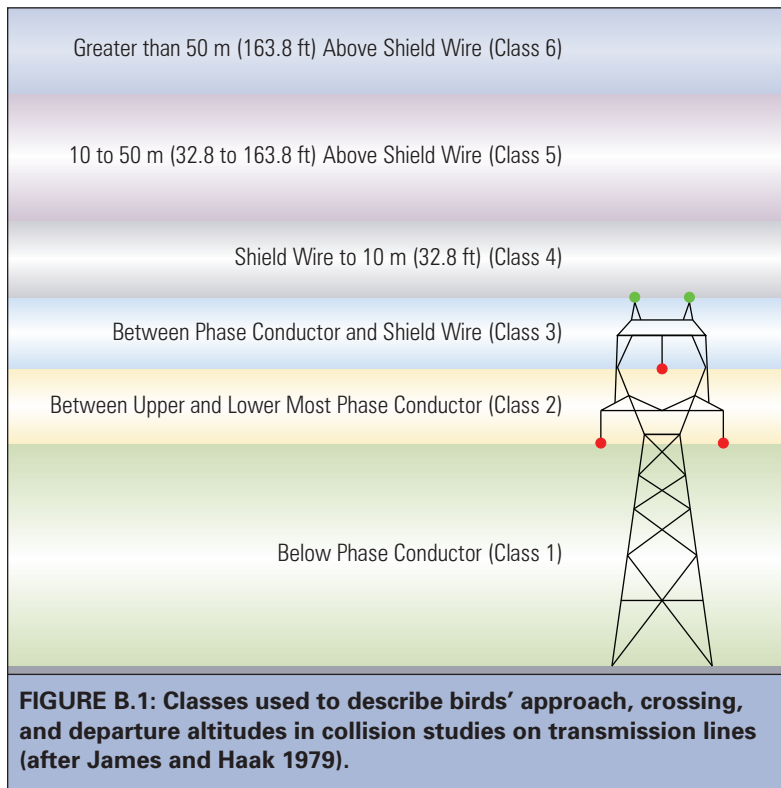
and distance from the line should be recorded. The following are possible reaction categories and definitions:

- No reaction—Birds maintain constant altitude and unaltered flight
- Swerve and over—Birds turn from course, flying up and over line
- Swerve and under—Birds turn from course, flying down and under line
- Over and swerve—Birds flying over line swerve immediately after crossing the lines
- Turn and leave—Birds turn and retreat from the line after approaching within 50 meters (m) (164 feet [ft]) of the line
- Collision and fly—Birds in flight hit a line but keep flying outside of the transect boundaries
- Collision and fall—Birds in flight hit a line and drop within the study transect (the specific line should be noted in the comments section)
- Land on line—Birds land on line or pole

Estimating Bird Flight Height

Bird flight altitude information should be estimated relative to the structure height and the height of phase conductors, neutral wires, and shield wires. Height classes will vary depending on the type of power line (e.g., conductor arrangement, voltage) and the species studied. [Figure B.1](#) provides an example of altitude classes for transmission lines. Since power lines will vary in design, site-specific altitude criteria should be developed.

The manner of recording flight altitude should be modified according to line configuration and the species studied. If the wires are in the same horizontal plane, then the area included in the study is above and below the line for a certain number of meters (feet). If the wires are in a vertical configuration, then the area observed is above and below the multiple planes including the shield wire and a distribution underbuild if present. If the structure type is an H-frame, then the obser-



vational box might be different than if the tower is steel lattice or a V-shape supported by guy wires. The size of the line structure may warrant extending the observational area farther from the poles (i.e., begin recording at 30.5 m (100 ft) away from a distribution single pole, but 152.4 m (500 ft) from a steel lattice transmission tower) in order to account for reaction times related to the size of the structure and the height and arrangement of the lines.

Bird flight height can be estimated and measured in various ways with varying degrees of expense, effort, accuracy, and efficiency. Visual categorization, rangefinders, and radar systems can all collect data on the flight height and each approach has its advantages and disadvantages (see *Radar Observation and Detection* on page I40). When choosing which techniques to use, the following must be considered: project goals, species identification and concentration, migration data,

and project budget. For example, if the major bird migration occurs in spring, data needs to be collected for a sufficient period in the spring to characterize bird movement and behavior. If you need to estimate the overall impacts of the mortality to the local bird population, you will need an understanding of that population in the area surrounding the study site throughout its seasonal fluctuations including breeding, migration, and wintering.

One of the simplest field techniques for estimating flight height is to visually categorize height, such as above the lines, below the lines, etc. This approach only requires a known reference point in the field. Survey flags and reaction zones can help observers estimate the distance from the line and the section of the line as they record behavioral avoidance. For example, survey flags can be placed 5 m (16.4 ft), 5 to 25 m (16.4 to 82 ft), and >25 m (>82 ft) from the line (Brown and Drewien 1995). This technique works well in terrestrial situations and eliminates the need for a rangefinder. In another approach, a reaction zone of 200 m (656.2 ft) on each side of a 500-kV transmission line has been used (Willdan Associates 1981, 1982).

This approach can be expanded by using visual estimation in conjunction with electronic rangefinders, which are used to measure the height of reference structures in the field. Electronic rangefinders come equipped with a laser and built in clinometers, which measure straight line distance to the bird and the angle of the measurement above horizontal. The measurements can be used to estimate an object's (bird's) height above ground. Height is calculated as:

$$\text{SIN}([\text{Angle}^1]) * [\text{Distance to Object}] = \text{Flight height}$$

¹ if calculating in Excel use the radian function to convert degree units into radians so the number will be compatible with the SIN function

Once the heights are known for several tall objects in the area, bird flight heights can be estimated. This approach can be further expanded by directly measuring the flight heights of birds using an electronic range-finder. This approach can be effective if birds are in close range and are big and reflective enough to bounce a signal back to the range-finder. Other factors that affect successful measuring of flight height using the rangefinder include:

- Distance of the observer to the bird (shorter distances reflect better signals)
- Size of the bird (larger birds reflect the laser better than smaller birds)
- Reflectivity of the bird (white birds reflect the signal better than dark birds; Klimentjew et al. 2010; M. Schriener, pers. comm.)

A limitation of measuring bird flight height directly is that it is difficult to record multiple heights simultaneously. In areas where bird passage rates are high, multiple observers, digital tape recorders, or video cameras may be needed to adequately capture multiple measurements of flight height.

Radar Observation and Detection

Although the use of radar in power line studies is not common, it is a useful tool for characterizing bird movements. Two types of radar, Nexrad and portable radar, have been used in bird studies to collect data on nocturnal movements and broad front migrations, which may be missed by field observations. Nexrad radar (Next-Generation Radar) is a network of Doppler weather radars operated by the National Weather Service. Nexrad radar has the advantage of being able to collect data on the density of targets within an area and examine the temporal variation in target activity over many years. Portable radars are smaller and include systems such as modified marine, pencil beam tracking, and other specialized radar systems. Portable

radar collects data on flight height, direction, and speed of targets and can distinguish different size classes of targets which provides some level of certainty as to what is being detected (e.g., songbirds versus herons).

Despite the unique information that radar can collect, it does have limitations. Nexrad cannot distinguish between birds, bats, and insects, and the height of airspace that is surveyed is dependent on the distance from the Nexrad station. Portable radar detects targets (e.g., birds, bats, insects, weather, etc.) in flight and can classify them by size and speed and movement patterns (R. Larkin, pers. comm.). Software filters can help refine target specificity by removing weather images, leaving images of desired targets. While size classes can be used to indicate species groups to some extent, distinguishing between species groups that are of similar size is not possible. Ground clutter, visual obstructions, and inclement weather can also limit the ability of radar to detect objects at a distance. The longer the distance between radar and subject, the more likely ground clutter will interfere. Finally, the cost of radar systems can be high, which limits their applicability.

Metrics

Metrics used in behavioral observations of collisions are generally expressed as the number of observed collisions per number of birds flying by a line (flybys), often expressed as a percentage. For example, Meyer (1978, cited in Bevanger 1998) observed the number of collisions to be 0.003% to 0.07% of flybys for waders and gulls. Janss and Ferrer (2000) reported collisions per flyby as 3.93×10^{-5} for the common crane (*Grus grus*) and 6.34×10^{-3} for the great bustard (*Otis tarda*).

Study Segments

It is essential that study segments represent the line as a whole (unless there is a need to identify high risk areas), that test and control segments be of comparable length, and that

they have as much environmental homogeneity as possible. Variability will be reduced by including an adequate number of test and control segments. Contiguous segments are convenient but not essential. Koops and de Jong (1982) marked alternating spans, and Brown and Drewien (1995) marked alternate 0.8-kilometer (km) (0.5-mile [mi]) segments of eight different test lines. The length of study segments may vary according to bird density, seasonal use, habitat type, size of the power line, etc. However, in line modification studies it is important that test and control segments are separated sufficiently so control segments are not affected by the presence of markers on the test segments. Thus, when evaluating markers on small distribution lines that have short spans (pole to pole distance), each test and control segment should consist of several spans. Barrientos et al. (2011) provides recommendations on reasons for standardizing segment length.

MORTALITY MONITORING SURVEYS

The most common way to determine if collisions have occurred is to survey the power line right-of-way (ROW) for dead and injured birds and attempt to identify the cause of injury or death. Mortality monitoring surveys provide a more accurate assessment of collision mortality.

Differences in Sampling Design

There are numerous monitoring approaches and each has different strengths and weaknesses (e.g., APLIC 1994; Bevanger 1999; Hunting 2002). Mortality surveys conducted through 2011 generally differ in sampling design including:

- Segment selection
- Lengths of lines sampled
- Width of the area sampled
- Duration and intensity of the study
- Seasonal sampling

The fact that all these considerations are not routinely included leads to difficulty in comparing studies (Hunting 2002; Barrientos et al. 2011). Typically the sampling biases (i.e., searcher efficiency, crippling loss, scavenger removal, and habitat differences; see [Sampling Biases](#) on page I43), which need to be accounted for to correct the estimated mortality rates, are not implemented systematically or in a manner that is consistent with the expected monitoring program survey designs. In addition, because of sampling uncertainty, a variety of statistical methods are applied to estimate the actual number of birds affected based on the number of birds found.

Site-specific study designs and correction factors need to be developed for mortality monitoring to account for these variables. Bevanger (1999) concluded that, given the site-specific factors and local conditions (e.g., biological, environmental, and engineering) that influence collision and mortality estimation, it is not expedient to develop a set of standard study design methods or use general correction factors. Barrientos et al. (2011) presented three recommendations for conducting line marking device effectiveness studies that also apply to mortality monitoring:

1. Collecting data on carcass counts and flight frequency for the same length of time and at the same time of the year at marked and unmarked wire segments
2. Studying marked (test segment) and unmarked (control segment) lines in areas with similar vegetation and topography, with similar lengths of time spent searching for carcasses, and with transects of equal lengths and widths
3. Standardizing the timing of carcass searches and search area widths

For search area width, searches should cover the width of ROW with reference to the height of the power line (James and Haak 1979; Raavel and Tombal 1991) and the zone in which carcasses are expected to fall.

Questions to Ask

The study design phase should focus on the questions being asked, the data needed to answer these questions, and the appropriate methods, including duration and intensity, to provide those data. A series of hierarchical questions that need to be considered may include the following:

1. Are collision injuries and/or mortalities occurring?
2. What species of birds are involved? Are they protected species?
3. Where along the power line are the birds colliding?
4. When are they being killed?
5. Under what circumstances (e.g., weather, time of day) are they being killed?
6. What biological, environmental, and engineering factors appear to be important in influencing collisions?
7. What line modification actions can be taken to reduce these collisions?

Questions 1 and 2 are the simplest to answer if the carcasses are detected. Many of the past studies have focused on answering the first two questions and sometimes 3 and 4. More recent studies have attempted to address questions 5, 6, and 7. There is a tendency to focus on sampling worst-case situations or locations where high numbers of collisions have occurred as opposed to sampling representative locations along a given power line to understand the overall collision risk. Although results from worst-case situations may skew general mortality risk, determining this information is still important because it provides data needed for reducing risk.

Data to Record

For each bird found, the following information should be gathered when possible:

- Location of the carcass in proximity to the power line (e.g., GPS position)
- Species
- Sex
- Age: adult or juvenile
- Date or approximate time of death
- Physical injuries and conditions (e.g., broken bones, lacerations, abrasions, blood, discolorations, gunshot wounds, decomposition, feather spots, feeding by scavengers)
- Probable cause of death
- Necropsy¹⁹

Environmental conditions should also be recorded, especially visibility, wind speed and direction, weather events, avian habitats, as well as the type and abundance of bird species in the study area.

Remote Sensing

An alternative to directly observing bird collisions is to use a Bird Strike Indicator (BSI). BSI is a vibration sensing and recording tool that is fitted to a power line to detect collisions with that line. It is especially useful for monitoring collisions in low-light or no-light conditions. However, BSI does not identify what species struck the line; mortality monitoring or field observations would be required to determine this. See [Chapter 5](#) for a discussion on the BSI.

¹⁹ In the United States, the possession of any protected migratory bird will require a Special Purpose or Scientific Collecting permit (see [Chapter 3](#)), unless otherwise instructed by an agent of U.S. Fish and Wildlife Service Office of Law Enforcement.

ISSUES RELATED TO ESTIMATING MORTALITY RATES

EQUATIONS FOR CALCULATING MORTALITY RATE

Accuracy

Few mathematical equations for estimating mortality have been tested for accuracy using experimentally designed, rigorous field studies (Bevanger 1999). Furthermore, there are no agreed upon methods that link the equation to the type of field trials necessary for site-specific calculation of mortality, nor are methods for incorporating uncertainty often provided.

These issues are not unique to power lines. Similar uncertainty is found in calculating actual mortality from estimates of bird carcasses collected from wind turbine collisions, building window collisions, pesticide application, and avian diseases. Although the causes of mortality are different, the ability to find bird carcasses in the field is affected by the same sampling biases (i.e., crippling loss, searcher efficiency, scavenger removal, and habitat differences; see discussion on this page). Huso (2011) evaluated the accuracy and precision of mortality estimators for power lines and other structures and proposed one that improves reliability. This limitation in calculating mortality rates is also presently being investigated by the wind industry, U.S. Fish and Wildlife Service, U.S. Geological Survey, and others. The California Energy Commission (CEC) is funding a controlled field study through the California Wind Energy Association strictly looking at the mathematical relationships of scavenger removal and searcher efficiency as they relate to calculating actual mortality rates. The study report should be available in 2012 (J. Newman, pers. comm.).

Variability in Methods

While designing a study, the most recent literature on mortality rate calculations should be reviewed before selecting a particular method. Bevanger (1999) and Hunting

(2002) provide an excellent review of collision mortality for power lines. A mortality rate of the number of carcasses/distance of line surveyed/time period is the most commonly used metric found in the literature. However, the search area (i.e., estimated annual mortality/hectare/kilometer [acre/mile]) also needs to be included (Hunting 2002).

Finally, as mentioned earlier, there is great variability in monitoring methods, which prevents useful comparison of mortality rates and effectiveness of markers to reduce collisions.

SAMPLING BIASES

When conducting mortality monitoring, the mortality rate calculation must take a number of sampling biases into account, including the following:

- Crippling loss
- Searcher efficiency
- Scavenger removal
- Habitat differences

Crippling Loss Bias

The crippling loss bias occurs when birds strike a line and fall outside the search area or when injured birds move out of the search area and are not observed by searchers. Bevanger (1999) cites several studies that found 22% (Hiltunen 1953) to 50% (Renssen et al. 1975) to 74% (Beaulaurier 1981) of birds fatally injured in power line collisions move far enough away from the power line before dying that they are not found during carcass searches.

In Beaulaurier's (1981) study, crippling loss bias was defined as the percent of observed collisions in which birds continued flying out of the study area after the collision. Because she did not observe a collision during her study, she used an estimate of 74%—the average measure of crippling loss bias calculated by Meyer (1978) as 75% and James and Haak (1980) as 73%. These authors assume

a worst-case estimate with all injured birds dying from their injuries. The estimates were also based on collisions with shield wires.

Because great time and effort are involved in monitoring flights and recording collisions, crippling loss bias estimates are extremely difficult to obtain and they are the least likely to be calculated in a study. Application of estimates from other studies is inappropriate, and, in fact, very misleading. Once again, the size of the bird may make a significant difference because of flight dynamics. A crane or swan that just tips a line is more likely to tumble to the ground and sustain fatal injuries than is a smaller, lighter bird that may be able to recover its flight mid-air and die later at some distance from the line (W. Brown, pers. comm.). Consequently, smaller birds might have a higher crippling loss bias than larger birds. This may need to be examined in future research.

Searcher Efficiency Bias

During carcass searches, some of the carcasses will be missed depending on several variables (e.g., number of observers, their skill and experience, and how the surveys are conducted). This is called searcher efficiency bias or searcher bias. Searcher bias is also influenced by vegetation type, height, and density, search pattern, presence of waterbodies, bird size, and other factors (Bevanger 1999; Erickson et al. 2005). Searcher bias in carcass detection must be carefully controlled (Bevanger 1999; Erickson et al. 2005). Searcher efficiency biases are specific to the site and the season. Bias needs to be determined while the mortality monitoring is taking place and not extrapolated from or to other locations, seasons, or studies (Bevanger 1999; Barrientos et al. 2011). APLIC (1994) and Bevanger (1999) give examples of the calculations for determining searcher bias. CEC is also studying searcher efficiency factors for calculating wind turbine-caused bird mortality.

The use of trained dogs in mortality monitoring studies can increase carcass recovery, particularly of small carcasses in dense vegetation (Homan et al. 2001; Anderson 1978; Rusz et al. 1986; Bevanger 1995, cited in Bevanger 1999). However, the availability of trained dogs is limited and their efficiency varies with individuals, seasons, weather conditions, vegetation structure, breed, length of use, and level of fatigue.

Scavenger Removal Bias

Scavengers may remove carcasses before a search is completed, which results in underestimating mortality. Scavenging rates are very important to include in mortality rate estimation (Bevanger 1999; Rivera-Milan et al. 2004; Erickson et al. 2005; Gehring et al. 2009). Bevanger (1999) gives an example of the calculation. Scavenging rate varies by habitat, season, time of day, scavenger type, bird size, bird species, etc. (Bevanger 1999; Erickson et al. 2005). Evidence of seasonal variation in scavenging rates in United Kingdom farmland is presented by Prosser et al. (2008).

In some cases scavenging can be a quick process, occurring in a matter of minutes depending on the scavenger species as well as the bird species involved. A review of the scavenging studies from various mortality monitoring studies (including power lines, communication towers, wind turbines, pesticide application, and bird disease) indicates that the majority of scavenging takes place within a short period of time after death for many species. For example, preliminary results of a scavenging removal study at one communication tower location on the Alaska Peninsula suggest that carcass removal from scavenging is as high as 50% removal per day (P. Flint, USGS pers. comm.; E. Lance, USFWS pers. comm.; USFWS 2007 unpubl. Data, cited in Manville 2007a); scavenged carcasses included eiders, waterfowl, and shorebirds,

among others. This degree of scavenging is consistent with what Herbert Stoddard (Crawford and Engstrom 2001) found in a 29-year study of a communication tower in Florida where about 92% of carcasses were removed by scavengers within 24 hours. Peterson et al. (2001) reported that in British Columbia, Canada, 52/54 poisoned waterfowl carcasses were discovered by avian scavengers within 72 hours. Kostecke et al. (2001) reported carcasses scavenged mostly by skunks with 66% of carcasses scavenged within five days in a South Dakota study. Erickson et al. (2005) cites a number of case studies with average carcass persistence times ranging from less than one to 28 days. In other cases it can be longer (Brown and Drewien 1995). They found that crane carcasses sometimes remained for as much as a year after death and that no crane carcasses were removed by scavengers during the removal studies. Likewise, large bird carcasses (e.g., raptors, pelicans) may persist for extended periods (several months to 32 months) without scavenger removal (S. Liguori, pers. comm.). Ravel and Tombal (1991) and others have noted that removal bias varies with the size of the birds (i.e., smaller birds usually disappear more quickly and more frequently). Consequently, the effects of size and perhaps species must be included in calculations of removal bias for a

study. In controlled studies where a known number of carcasses were placed in the field showed that many carcasses were removed within a short period time, e.g. days; however, even small birds can persist in the field for long periods of time as they become desiccated and less preferred for scavenging.

Scavenger removal bias is site-specific and needs to be determined when the mortality monitoring is taking place rather than extrapolating it from other locations, seasons, or studies (Bevanger 1999). Scavengers can quickly learn where carcasses or injured birds are readily available, suggesting the need to update these bias correction factors throughout the study, as needed, to account for learning behavior.

Habitat Differences Bias

Habitat bias is used to account for unsearchable areas. Some portions of a study area may not be searchable because of water, bogs, dense vegetation, or topography. Researchers should not extrapolate beyond the area sampled because the rate of collision may vary with habitat type. Habitat bias should be used only in situations where unsearchable habitat is finely interspersed with searchable habitat and where researchers can demonstrate that the numbers of birds found in searchable and unsearchable habitats are similar.

SAMPLE

THIS PAGE INTENTIONALLY LEFT BLANK



APPENDIX C

Glossary

adult

A bird that has acquired its final plumage.

aspect ratio

Aspect ratio is the wing breadth divided by wing length. A low aspect ratio generally correlates with relatively thin wings and high aspect ratio with relatively wide wings.

avian-safe

A power pole configuration designed to minimize avian electrocution risk.

circuit (multiple)

A configuration that supports more than one circuit.

circuit (single)

A conductor or system of conductors through which an electric current is intended to flow. The circuit is energized at a specified voltage.

conductivity

The capacity to transmit electrical energy.

conductor

The material (usually copper or aluminum)—usually in the form of a wire, cable, or bus bar—suitable for carrying an electric current (AC, DC, and shield); a material that offers little resistance to the flow of electricity.

conductor gallop

Also known as galloping. The high-amplitude, low-frequency oscillation of overhead power lines often due to wind. The movement of the wires occurs most commonly in the vertical plane, although horizontal or rotational motion is also possible. Galloping can cause power lines to slap together, which results in outages and damage to the lines and equipment. Icing conditions, wind velocity, and conductor tension are some of the factors that interact to cause galloping.

configuration

The arrangement of parts or equipment. A distribution configuration would include the necessary arrangement of crossarms, braces, insulators, etc. to support one or more electrical circuits.

conspecific

Members of the same species.

corona

A process by which current in a conductor with a high potential ionizes the air surrounding it to create a plasma. The ions generated eventually pass charge to nearby areas of lower potential or recombine to form neutral gas molecules.

corridor

The broad area between the origin and termination of a new line, within which the potential routes lie. The area in which a new line's routing alternatives are proposed and evaluated before the final route is determined.

corvid

Birds belonging to the family Corvidae; includes crows, ravens, magpies, and jays.

crossarm

A horizontal supporting member used to support electrical conductors and equipment for the purpose of distributing electrical energy. Usually made of wood, fiberglass, or steel, and manufactured in various lengths.

current

A movement or flow of electricity passing through a conductor. Current is measured in amperes.

distribution line

Lower-voltage wires, energized at voltages from 2.4 kV to 60 kV, and used to distribute electricity to residential, industrial, and commercial customers, i.e., end users.

facility

As used in this manual, this term refers to all the equipment, wires, structures (e.g., poles and towers), etc., that are involved in carrying electricity.

fault

A power disturbance that interrupts the quality of electrical supply. A fault can have a variety of causes including fires, ice storms, lightning, animal collisions/electrocutions, or equipment failures. Also known as arc, short circuit, or flash.

flappers

Suspended collision reduction devices that clamp to and hang from a line and swing and spin in the wind. There are variations on this theme that have little or no motion, which are used when high winds cause moving parts to wear rapidly.

flaring

A sudden panic avoidance reaction to power lines, in which birds ascend almost vertically with rapid wing beats or fold their wings and fall down and backwards away from the obstacle.

fledgling

A bird that has recently learned to fly and left the nest, but may still be dependent on its parents for food.

ground

Material that conducts electricity and makes an electrical connection with the earth.

ground rod

Normally a copper-clad steel rod or galvanized steel rod, driven into the ground so that the necessary parts of a facility can be physically connected to ground potential.

grounding conductor

A conductor used to ground the shield and neutral wires. Grounding conductors may be copper-clad, solid copper, or stranded galvanized wires and are attached to the structure. Sometimes also called a down wire. When steel structures are used the structure becomes the grounding conductor.

guy

Secures the upright position of a pole and offsets physical loads imposed by conductors, wind, ice, etc. Guys are normally attached to anchors that are securely placed in the ground.

immature

All plumages other than adult.

juvenile

(Plumage)—first plumage of a bird.
(Bird)—a bird in its first year of life.

Kilovolt (kV)

1,000 volts

latticework

The combination of steel members connected together to make complete structures, such as transmission towers or substation structures.

lightning arrester

An electrical protection device used to divert the energy of lightning strikes to the earth.

lightning days

Lightning or thunderstorm days. A day with one or more lightning storms would be classified as a lightning day.

maneuvering

Any change in flight behavior, height, or direction, and in this context, in response to obstacles such as power lines.

necropsy

Postmortem examination of wildlife often used to determine cause of death.

nestling

A young bird that has not yet reached sufficient size and maturity to leave the nest.

neutral wire

A non-energized conductor that carries the primary current back to its substation. The neutral is at ground potential (i.e., it grounds a distribution power line system).

outage

Event that occurs when the energy source is cut off from the load.

overhead ground wire

See [shield wire](#).

phase conductor

An energized power line that carries alternating current electricity.

phase-to-ground

The contact of an energized conductor to ground potential. A bird can cause a phase-to-ground fault when fleshy parts of its body touch an energized phase and ground simultaneously.

phase-to-phase

The contact of two energized conductors. Birds can cause a phase-to-phase fault when the fleshy part of their wings or other body parts contact two energized conductors of different phases at the same time.

pole

1. A vertical structure used to support electrical conductors and equipment for the purpose of transporting electrical energy. It can be made of wood, fiberglass, concrete, or steel and manufactured in various heights.
2. DC transmission lines use bundled conductors also known as poles, which refers to the positively and negatively charged conductors in a DC design.

power generation facility

The location where electricity is generated, which may be a power plant, station, wind turbines, solar farm, or hydro-electric dam, among others.

power line

A line made of conductive material that transmits electricity from its source to its point of use.

ramping

A contemplated maneuver frequently seen in wading birds approaching a power line at or below conductor levels. During their approach waders swerve and continue parallel to the power line until sufficient altitude is reached for crossing. Ramping is most frequently observed on clear days with moderate winds and apparently allows birds to assess and negotiate the power line before crossing.

raptor

Bird of prey. Raptors are members of the orders Falconiformes (diurnal raptors) and Strigiformes (owls). Raptors have a sharp hooked bill and sharp talons used for killing and eating prey.

rebuild

The act of upgrading an existing line by replacing its wires and/or structures.

reliability

The percentage of time a line is delivering uninterrupted electricity.

reroute

The act of removing an existing line from the original right-of-way and rebuilding it along another route that will avoid the interactions encountered in the original route.

retrofit

The modification of an existing electrical power line structure to make it avian-safe.

right-of-way (ROW)

The strip of land that has been acquired by an agreement between two or more parties for the purpose of constructing and maintaining a utility easement. The width of right-of-way required by each voltage level is generally dictated by state statutes and the National Electrical Safety Code (NESC) and is a function of span length, the conductor height above ground, and the conductor's low point of sag.

route

The pathway on which a right-of-way will be cleared and the new line constructed.

sailing

Crossing of conductors and shield wires with wings set. Most frequently seen in birds flying through or close to the conductor-shield wire complex.

separation

The physical distance between energized conductors or between energized and non-energized conductors.

shield wire

Also called static wire or overhead ground wire. A conductor that provides a path to ground for static electricity. Lightning is its most common source of static electricity. Since lightning follows pathways to ground, the shield wire protects phase (AC) and pole (DC) conductors from lightning strikes.

shortstopping

Wintering in more northerly latitudes than has been historic for the species.

siting

The process of identifying the points in the electrical system that need new lines of connection to deliver electricity to growing or new demand centers.

span

The pole-to-pole or tower-to-tower distance of a power line.

static wire

See **shield wire**.

structure

A pole or lattice assembly that supports electrical conductors and equipment for the transmission or distribution of electricity.

subadult

Stage of a bird between juvenile and adult.

substation

A transitional point (where voltage is increased or decreased) in transmission and distribution systems.

transmission line

Power line that delivers electricity from its source over long distances to substations where the voltage is reduced for distribution. Transmission voltages range from 60 to 765 kV in the United States.

trust resource

Wildlife held in the public trust and managed and protected by federal and state agencies. These trust agencies are designated by statute and regulations as responsible for upholding the protection, conservation, and management of these resources.

underbuild

Refers to a circuit that is placed on the same pole but underneath another circuit of a higher voltage. The lower circuit is often referred to as the underbuilt circuit.

volt

The measure of electrical potential.

voltage

Electromotive force can be expressed in volts. Power lines are rated and categorized by voltage.

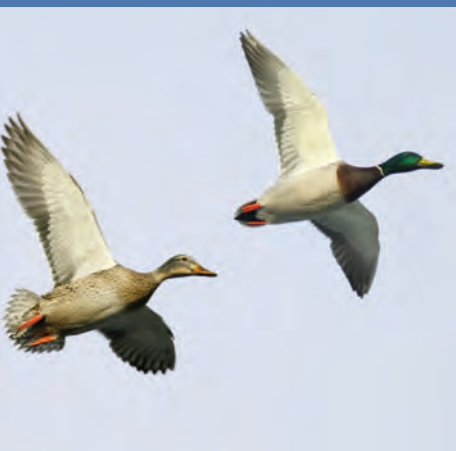
voltage rating

The voltage rating of a transmission line depends on the utility's existing transmission system voltages, interconnections with other utilities, potential delivery points, and the amount of power that must be transmitted to meet load requirements. As voltages increase, the amount of power that can be transmitted increases. Various line-design parameters such as conductor size and configuration, spacing, and the number of conductors per phase (bundling) allow for increased transmission capability. Transmission voltages for carrying energy long distances are generally in the 115- to 765-kV range in North America.

wing loading

Wing loading is a bird's mass divided by its wing surface area. High wing loading describes a bird that is heavy relative to its wing area. Low wing loading describes a bird that is light relative to its wing area.

SAMPLE



APPENDIX D

Acronyms

AC	Alternating Current	GIS	Geographic Information Systems
ACP	Advanced Conservation Practice	GPS	Global Positioning System
APLIC	Avian Power Line Interaction Committee	HCP	Habitat Conservation Plan
APP	Avian Protection Plan	HVAC	High Voltage Alternating Current
AWBP	Aransas-Wood Buffalo Population (whooping cranes)	HVDC	High Voltage Direct Current
BAMS	Bird Activity Monitoring System	in	inch
BFD	Bird-Flight™ Diverter	ITP	Incidental Take Permit
BGEPA	Bald and Golden Eagle Protection Act (United States)	km	kilometer
BSI	Bird Strike Indicator	kV	kilovolt
CAP	Citizens Advisory Panel	m	meter
CEC	California Energy Commission	mi	mile
cm	centimeter	MBCA	Migratory Birds Convention Act (Canada)
CFR	Code of Federal Regulations (United States)	MBTA	Migratory Bird Treaty Act (United States)
COSEWIC	Committee on the Status of Endangered Wildlife in Canada	MOU	Memorandum of Understanding
CWS	Canadian Wildlife Service	NESC	National Electrical Safety Code
DC	Direct Current	NMFS	National Marine Fisheries Service (United States)
EEI	Edison Electric Institute	NRECA	National Rural Electric Cooperative Association
EPRI	Electric Power Research Institute	PVC	Polyvinyl Chloride
ESA	Endangered Species Act (United States)	ROW	Right-of-Way (singular), Rights-of-Way (plural)
FAA	Federal Aviation Administration	SARA	Species at Risk Act (Canada)
ft	feet	SFD	Swan-Flight™ Diverter
		SVD	Spiral Vibration Damper



USEPA	U.S. Environmental Protection Agency	USGS	U.S. Geological Survey
USFWS	U.S. Fish and Wildlife Service	UV	Ultraviolet
		V	Volt

SAMPLE



APPENDIX E

Resources

BIRD IDENTIFICATION AND NATURAL HISTORY**All About Birds**

Cornell Lab of Ornithology

Includes bird identification information and bird songs.

www.allaboutbirds.org/Page.aspx?pid=1189

Birds of North America

Cornell Lab of Ornithology

Comprehensive reference covering the life histories of North America's breeding birds.

<http://bna.birds.cornell.edu/bna>

Tools for Learning About Birds

USGS Patuxent Wildlife Research Center

Includes bird pictures and songs.

www.mbr-pwrc.usgs.gov/bbs/ident.html

Bird Identification Pages

Idaho Museum of Natural History

Includes a visual key with silhouettes.

<http://imnh.isu.edu/digitalatlas/bio/birds/main/birdid.htm>

Florida Bird Sounds

Florida Museum of Natural History

www.flmnh.ufl.edu/birds/sounds.htm

BIRD DATABASES AND CONSERVATION INFORMATION**Migratory Bird Program**

USFWS Division of Migratory Birds

Resources and regulations for the conservation and management of migratory birds.

www.fws.gov/migratorybirds

Migratory Bird Treaty Act (MBTA)

USFWS Division of Migratory Birds

www.fws.gov/laws/lawsdigest/migtrea.html

Bald and Golden Eagle Protection Act (BGEPA)

USFWS Division of Migratory Birds

www.fws.gov/laws/lawsdigest/baldegl.html

Endangered Species Act of 1973 (ESA)

USFWS Division of Migratory Birds

www.fws.gov/laws/lawsdigest/esact.html

Endangered Species Consultation Handbook (1998)

USFWS and NMFS

Procedures for conducting consultation and conference activities under Section 7 of the Endangered Species Act.

www.fws.gov/midwest/endangered/section7/index.html

North American Waterfowl Management Plan

USFWS Division of Bird Habitat Conservation
Includes waterfowl status reports.
www.fws.gov/birdhabitat/NAWMP/index.shtm

Bird Conservation Initiatives

U.S. Environmental Protection Agency
Portal to major United States bird conservation plans and organizations.
www.epa.gov/owow/birds/bird.html

Conservation Plans, Databases, Strategies, and Assessments

Partners in Flight—U.S.
www.partnersinflight.org

North American Landbird Conservation Plan (2004)

Partners in Flight
www.pwrc.usgs.gov/pif/cont_plan

U.S. Shorebird Conservation Plan (2001)

USFWS
www.fws.gov/shorebirdplan

North American Waterbird Conservation Plan (2002)

Waterbird Conservation for the Americas
www.pwrc.usgs.gov/nacwcp/nawcp.html

Migratory Birds (Canada)

Environment Canada
Conservation, monitoring and reporting, and regulations for Canadian migratory birds.
www.ec.gc.ca/nature/default.asp?lang=En&n=FDF836EF-I

Migratory Birds Convention Act and Regulations (Canada)

Environment Canada
Policies, regulations, and list of birds protected in Canada under the MBCA.
www.ec.gc.ca/nature/default.asp?lang=En&n=7CEBB77D-I

Species at Risk Public Registry (Canada)

Government of Canada
Information and regulations for at-risk species in Canada.
www.sararegistry.gc.ca/default_e.cfm

Committee on the Status of Endangered Wildlife in Canada

Committee of experts that assesses wildlife species in danger of disappearing.
www.cosewic.gc.ca/eng/sct5/index_e.cfm

North American Bird Conservation Initiative

Bird Studies Canada
Describes and maps the North American bird conservation regions.
www.bsc-soc.org/nabci.html

Christmas Bird Counts

National Audubon Society
Annual “snapshot” of North American bird populations over many decades. Because of issues with detection and database limitations, this database should only be used for indications of species presence and season of use.
<http://birds.audubon.org/christmas-bird-count>

eBird

Audubon and Cornell Lab of Ornithology
International database of bird observations with graphs and range maps. Because of issues with detection and database limitations, this database should only be used for indications of species presence and season of use.
<http://ebird.org/content/ebird>

Avian Knowledge Network (AKN)

Downloadable version of the eBird reference dataset for the Western Hemisphere.
www.avianknowledge.net/content

National Biological Information Infrastructure: Bird Conservation
USGS Biological Informatics Program
 Portal to maps, data, and bird conservation procedures for conservation of bird populations and their habitats in North America.
www.nbio.gov/portal/server.pt/community/bird_conservation/460

Ornithological Information System (ORNIS)
National Science Foundation
 Data from collections of a network of museum and academic partners.
www.ornisnet.org

North American Breeding Bird Survey
U.S. Geological Survey
 Data since 1966 on the status and trends of North American bird populations. Because of issues with detection and database limitations, this database should only be used for indications of species presence and season of use.
www.pwrc.usgs.gov/BBS

Landbird Population Estimates Database
Partners in Flight/Rocky Mountain Bird Observatory
 Based on the Breeding Bird Survey data of the 1990s.
www.rmbio.org/pif_db/laped/default.aspx

Raptor Information System
U.S. Geological Survey
 Keyword catalog of over 32,000 references on the biology and management of raptors.
<http://ris.wr.usgs.gov>

BIRD/ENERGY PROGRAMS AND AVIAN PROTECTION PLANNING

Suggested Practices for Avian Protection on Power Lines: The State of the Art in 2006
Avian Power Line Interaction Committee
www.aplic.org/documents.php

Avian Protection Plan Guidelines 2005
Avian Power Line Interaction Committee and USFWS
www.aplic.org/uploads/files/2634/APPguidelines_final-draft_April2005.pdf

Short Courses and Workshops on Avian-Power Line Interactions
Avian Power Line Interaction Committee
www.aplic.org (see Upcoming Events)

California Energy Commission
www.energy.ca.gov/index.html

On-Line Annotated Bibliography of Avian Interactions with Utility Structures
California Energy Commission
www.energy.ca.gov/research/environmental/avian_bibliography

Right-of-Way Siting, Vegetation Management, and Avian Issues—Program 57
Electric Power Research Institute
<http://portfolio.epri.com/ProgramTab.aspx?slId=ENV&rId=I34&pId=5117>

Conserving Birds and Their Habitats on Department of Defense Lands
U.S. Department of Defense and Partners in Flight
 Includes a variety of resources such as bird conservation maps and avian protection planning guidelines.
www.dodpif.org

Materials on Bird-Power Line Interactions for Electric Utilities and their Employees
New Mexico Avian Protection Working Group
<http://nmavianprotection.org//resources.html>

Wildlife and Energy Programme
Endangered Wildlife Trust
www.ewt.org.za/WHATWEDO/OurProgrammes/WildlifeEnergyProgramme.aspx

HIGH VOLTAGE DIRECT CURRENT (HVDC) TRANSMISSION SYSTEMS

Technology Information, Resource Library, and Student/Teacher Education
Clean Line Energy Partners
www.cleanlineenergy.com

AVIAN HEALTH, MORTALITY, AND CARCASS IDENTIFICATION

National Wildlife Health Center
U.S. Geological Survey
www.nwhc.usgs.gov

Field Manual of Wildlife Diseases, General Field Procedures and Diseases of Birds
U.S. Geological Survey
www.nwhc.usgs.gov/publications/field_manual

Wildlife Health Bulletin #06-02: Wild bird mortality reporting
U.S. Geological Survey
www.nwhc.usgs.gov/publications/wildlife_health_bulletins/WLHB_06_02.jsp

Avian Necropsy Manual for Biologists in Remote Refuges
U.S. Geological Survey
http://www.nwhc.usgs.gov/publications/necropsy_manuals/index.jsp

Causes of Mortality in Common Loons
U.S. Geological Survey
www.nwhc.usgs.gov/publications/documents/92JCF.CLE01.pdf

Field Guide to Raptor Remains
California Energy Commission
www.energy.ca.gov/index.html

Wing and Tail Image Collection
 (Useful for Carcass Identification)
University of Puget Sound
www.pugetsound.edu/academics/academic-resources/slater-museum/biodiversity-resources/birds/wing-image-collection

PUBLIC PARTICIPATION RESOURCES

Introduction to Public Participation
Edison Electric Institute
 Practical information for working with the public as a partner.
www2.eei.org/products_and_services/descriptions_and_access/intro_public_partic.htm

Bird Education Network
Council for Environmental Education
 Coalition developing a national strategy for bird education.
www.birdeducation.org

Flying Wild
Council for Environmental Education
 Classroom bird education resources.
www.flyingwild.org

International Migratory Bird Day
Environment for the Americas
 Annual event focusing on migratory birds of the Americas.
www.birdday.org

Project BEAK (Bird Education and Awareness for Kids)
Nebraska Partnership for All-Bird Conservation, Nebraska Environmental Trust, Nebraska Game and Fish Commission, U.S. Environmental Protection Agency
 Exemplary bird education program.
<http://projectbeak.org>

National Wildlife Refuge System

U.S. Fish and Wildlife Service

552 refuges, many of which focus on bird conservation and public outreach.

www.fws.gov/refuges

FUNDING ORGANIZATIONS**Avian Power Line Interaction Committee**

APLIC funds research projects that further the knowledge of avian/power line interactions, including causes and solutions to avian mortalities due to power line electrocutions and collisions.

www.aplic.org/proposals.php

California Energy Commission

CEC funds various programs; see their website for a complete list.

www.energy.ca.gov/contracts/index.html

Electric Power Research Institute

EPRI funds research and development through competitive selection of contractors.

<http://my.epri.com>

(see About EPRI and Contractor Resources)

SAMPLE

SAMPLE

THIS PAGE INTENTIONALLY LEFT BLANK

SAMPLE

THIS PAGE INTENTIONALLY LEFT BLANK

